

# Surge Protection



Powering Business Worldwide

## Type Overview

**SP B T12 - 280 - 3+NPE / BB**

Product Group	
SP	Surge Protection

Product Family		
Z	Combined testclass SPD for 40 mm busbar	T1 T2 T3
R	Combined testclass SPD for critical infrastructure	T1 T2
B	Combined test class SPD for applications with an established lightning protection system	T1 T2
C	Class 2 tested (some types are additional class 3 tested)	T2 T3
E	Class 2 tested SPD to fulfill minimum requirements	T2
D	Class 3 tested SPD to protect sensitive devices in a fixed installation	T3
PV	Test class 2 and combined test class SPD for PV applications	T1 T2

Test Class	
T1	Required, if an external lightning protection system is established
T2	Minimum requirement if no external lightning protection system is established
T3	Protection for sensitive device in a fixed installation

Continuous operational voltage (Uc)
The SPD is non-conductive up to this voltage level! This value is set by national regulations and is dependent on the connected supply system.

Connection Types		
CT1	1+0 / 2+0 / 3+0 / 4+0	SPD between line and PE
CT2	1+1 (NPE) / 3+1 (NPE)	SPD between line and neutral connection Additional SPD between neutral and PE

Product Suffix	
AX	Auxiliary contact is fitted to the SPD
BB	SPD is pre-fitted with a busbar
H	Higher impulse discharge rating (Iimp)
OS	Special SPZT-S types with fused outgoing power supply

**Connection of SPDs**

**Connection Type 1 (CT1)**

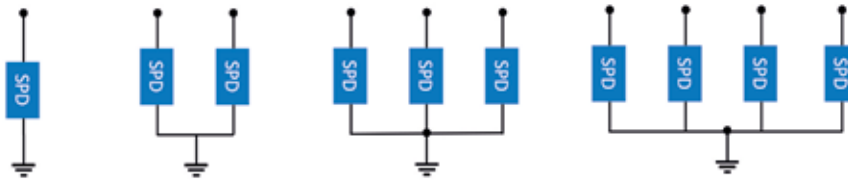

**SPD between every live connection and earth potential!**

- To be fitted in-front of an RCD
- The „3+0“ connection is used in TN-C and TN-C-S systems (if the PEN connection is established within 0.5 m)
- 2+0 / 4+0 connections are used in TN-S systems, given that no RCD is in-front of the SPD

**Connection Type 2 (CT2)**

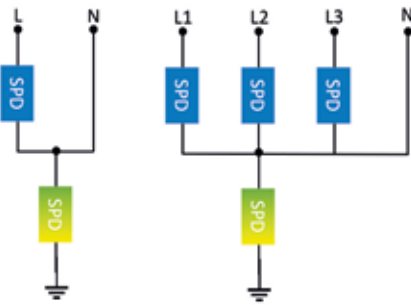

**An additional SPD is installed between neutral and protective earth (galvanic separation is ensured).**

- Can be installed behind an RCD (various conditions need to be met)
- 1+1 connection suited for TN-C-S and TT networks (single phase)
- 3+1 suited for TN-C-S and TT systems (three phase)
- Easy application due to the possibility to be fitted in front or after an RCD (dependent on supply network, test class and type of RCD)

**Connection of an SPD after an RCD**

- It is not recommended (or forbidden by local regulations) to install a test class 1 tested SPD after an RCD
- The minimum surge current capabilities for an RCD in-front of an SPD shall be 3 kA (established by type S/G/F/B RCDs)
- Please be aware that even a surge current proof RCD can trip if an SPD is placed in series
- Connecting neutral and protective Earth behind an RCD is forbidden. Galvanic separation is needed (1+1/3+1 connection)

### Installation of an SPD

#### Cross-section of the connected cables

##### Class 1 tested / class 1 and 2 tested SPDs

- At least **16 mm<sup>2</sup>** to earth potential
- Possibility to be reduced to 6 mm<sup>2</sup>\*

##### Class 2 tested SPDs

- At least **6 mm<sup>2</sup>** to earth potential
- Possibility to be reduced to 2 mm<sup>2</sup>\*

\* IEC-60364-4-43 allows a smaller cross-section, if the installation is performed in such a way, that damages due to short circuits are minimized

##### Cable length

The complete length of connecting cables shall not exceed 0.5 m!

If this is not possible:

- The installed SPD shall provide a sufficient voltage protection level (lower than the minimum required protection level for the installation)
- Installation of a second coordinated SPD which then fulfills the needed voltage protection level of the installation.

#### Max. back-up fuse

- Every SPD shall have back-up protection
- The back-up fuse shall establish a safe state of the installation after an SPD fails/reaches it's end of life
- This protection device shall be capable of handling the short circuit of the installation
- The internal resistance of the protection device influences the voltage protection level and shall be chosen accordingly

#### Endurance of an SPD

Every SPD has endurance capabilities which rely on following factors:

- Amount of discharges
- Amplitude of discharges
- Duration/waveform of discharges

A higher I<sub>max</sub> value can therefore offer a prolonged endurance of an SPD in an installation

#### Possible failure modes of SPDs

- High impedance fault, where the disconnection is done by the SPD itself.
- Low impedance failure, which requires the back-up protection to disconnect the SPD from the installation
- Interchanging fault

It should be noted, that the mode of disconnection of the SPD depends on the behaviour at it's end of life.

SG01321



## Description

- Combined class 1/2/3 tested SPD
- Intended to be used within meter boards according to VDE 0100-443/-534
- Fulfills the requirements of VDE-AR-N-4100 (Power supply for a gateway)
- Device with a small footprint to be mounted on a 40 mm-busbar
- To be placed in an Eaton ZSD for a complete solution

## Types

### SPZ „H“

- Higher limp rating of 12,5 kA
- To be used in applications with an external lightning protection system (LPS III/IV)

### SPZ „NPE“

- Suitable for TT and TN-S systems due to the 3+1 connection
- Also available as “H” types with higher limp rating

### Surge Protection SPZT123

The SPZT123 surge protection from Eaton is particularly intended for installations in buildings in accordance with VDE 0100-443/-534. It can be plugged into the 40 mm busbar of the meter distribution board (ZSD). The innovative phase tap saves costs and space: The SPZT123 can provide the power supply for a gateway and the APZ space via its phase tap without the need for an extra extension of the busbar system for a separate phase tap. Neither screws nor tools are required for installation. An appropriate housing design prevents incorrect positioning and automatically adapts to the 5 mm or 10 mm busbar.

Poles Type	Max. Continuous Operating Voltage $U_c$	Type Designation	Article No.	Units per package
------------	--	------------------	-------------	-------------------

#### Combined Surge Protective Device SPZT123-300/3+NPE-(H)

- for TT /TN-S

sg01321\_I



3pole+NPE	300 VAC	SPZT123-300/3+NPE	304956	1
		SPZT123-300/3+NPE-H	304960	1

#### Combined Surge Protective Device SPZT123-300-(H)

- for TN-C

sg01421\_I



3pole	300 VAC	SPZT123-300/3	304959	1
		SPZT123-300/3-H	304961	1

**Description Surge Protective Class T1/T2/T3 for Busbar mounting (40 mm), SPZT123-300-(H)**

- Ready-to-connect Combined Surge Protection Device Type 1/2/3 on the basis of hybrid arrester
- Field of application:  
For the protection of low voltage distribution systems against transient overvoltage caused by direct and indirect lightning stroke and switching operations
- Lightning protection classes III and IV according to IEC 62305
- Meets all requirements for installing surge protection according to DIN VDE 0100-534
- For TN-C grid type

**Technical Data**

	SPZT123-300/3	SPZT123-300/3-H
<b>General data</b>		
Standards/regulations	IEC 61643-11 2011, EN 61643-11: 2012+A11: 2018	IEC 61643-11 2011, EN 61643-11: 2012+A11: 2018
IEC-Testklassifizierung	<b>T1</b> / <b>T2</b> / <b>T3</b>	<b>T1</b> / <b>T2</b> / <b>T3</b>
EN type	T1 / T2 / T3	T1 / T2 / T3
Number of ports	1	1
SPD design	Hybrid	Hybrid
Mode of protection	L-PEN	L-PEN
Mounting type	40 mm busbar	40 mm busbar
Surge protection fault message	visual	visual
Color	Light grey RAL 7035	Light grey RAL 7035
Housing material	Thermoplastic	Thermoplastic
Flammability rating according to UL 94	V-0	V-0
Degree of protection	IP20 / IP40 in combination with cover	IP20 / IP40 in combination with cover
Ambient temperature (operation)	-40 °C ... 85 °C	-40 °C ... 85 °C
Ambient temperature (storage/transport)	-40 °C ... 85 °C	-40 °C ... 85 °C
Permissible humidity (operation)	5 % ... 95 %	5 % ... 95 %
Altitude	≤ 4000 m (amsl (above mean sea level))	≤ 4000 m (amsl (above mean sea level))
Width	47 mm	47 mm
Height	224 mm	224 mm
Depth	99 mm	99 mm
Horizontal pitch (incl. 5 mm)	2.6 Module units	2.6 Module units
<b>Electrical data</b>		
Nominal voltage AC	$U_o / U_N$ 240 V	240 V
Maximum continuous operating voltage	$U_C$ 300 V AC	300 V AC
Max. discharge current (8/20) $\mu$ s	$I_{max}$ 50 kA	50 kA
Nominal discharge current (8/20) $\mu$ s	$I_n$ 20 kA	20 kA
Impulse current (10/350) $\mu$ s	$I_{imp}$ 7.5 kA	12.5 kA
Short-circuit current rating (AC)	$I_{SCCR}$ 25 kA	25 kA
Open Circuit Voltage of Combination Wave Generator	$U_{OC}$ 6 kV	6 kV
Voltage protection level	$U_p$ 1500 V	1500 V
Responding time	$t_a$ < 100 ns	< 100 ns
TOV behavior at $U_T$	442 V	442 V
Max. backup fuse	315 A (gG)	315 A (gG)
Number of ports	1	1

# 1.4

## Surge Protection

xPole

Combined class 1/2/3 tested SPD for 40 mm busbar, SPZ

	SPZT123-300/3	SPZT123-300/3-H
<b>Technical Data</b>		
<b>Connection method</b>		
<b>Conductor cross section (max.)</b>		
solid, stranded	2 AWG, 35 mm <sup>2</sup>	2 AWG, 35 mm <sup>2</sup>
flexible	4 AWG, 25 mm <sup>2</sup>	4 AWG, 25 mm <sup>2</sup>
Stripping length	18 mm	18 mm
Tightening torque	4.5 Nm	4.5 Nm
<b>Additional supply terminal (LA)</b>		
Rated current integrierter Abgang	I <sub>n</sub> 6.3 A	6.3 A
Back-up fuse 5 x 20 mm	FF 6.3 A	6.3 A
Wire connection method	Push-In	Push-In
<b>Conductor cross section (max.)</b>		
solid, stranded, flexible	10 AWG, 4 mm <sup>2</sup>	10 AWG, 4 mm <sup>2</sup>

### Connection diagram

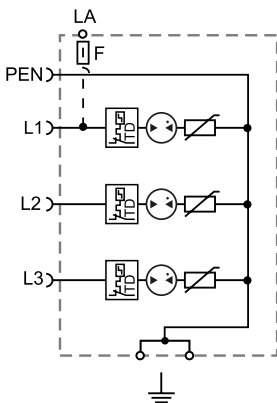

### Dimensions (mm)

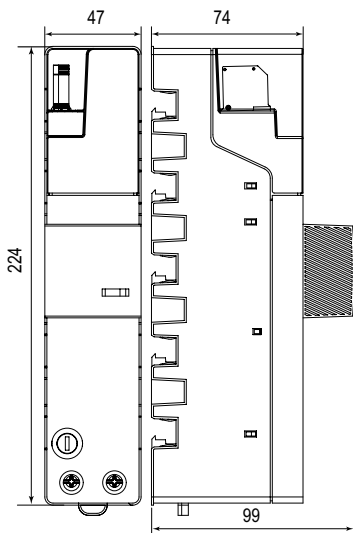



### Description Surge Protective Class T1/T2/T3 for Busbar mounting (40 mm), SPZT123-300/3+NPE(-H)

- Ready-to-connect Combined Surge Protection Device Type 1/2/3 on the basis of hybrid arrester
- For mounting on 40 mm busbar
- Field of application:
  - For the protection of low voltage distribution systems against transient overvoltage caused by direct and indirect lightning stroke and switching operations
- Lightning protection classes III and IV according to IEC 62305
- Meets all requirements for installing surge protection according to DIN VDE 0100-534
- For TT & TN-S grid type

### Technical Data

		SPZT123-300/3+NPE	SPZT123-300/3+NPE(-H)
<b>General data</b>			
Standards/regulations		IEC 61643-11 2011, EN 61643-11: 2012+A11: 2018	IEC 61643-11 2011, EN 61643-11: 2012+A11: 2018
IEC-Testklassifizierung		<b>T1</b> / <b>T2</b> / <b>T3</b>	<b>T1</b> / <b>T2</b> / <b>T3</b>
EN type		T1 / T2 / T3	T1 / T2 / T3
Number of ports		1	1
SPD design		Hybrid	Hybrid
Mode of protection		L-N, N-PE	L-N, N-PE
Mounting type		40 mm busbar	40 mm busbar
Surge protection fault message		visual	visual
Color		Light grey RAL 7035	Light grey RAL 7035
Housing material		Thermoplastic	Thermoplastic
Flammability rating according to UL 94		V-0	V-0
Degree of protection		IP20 / IP40 in combination with cover	IP20 / IP40 in combination with cover
Ambient temperature (operation)		-40 °C ... 85 °C	-40 °C ... 85 °C
Ambient temperature (storage/transport)		-40 °C ... 85 °C	-40 °C ... 85 °C
Permissible humidity (operation)		5 % ... 95 %	5 % ... 95 %
Altitude		≤ 4000 m (amsl (above mean sea level))	≤ 4000 m (amsl (above mean sea level))
Width		47 mm	47 mm
Height		224 mm	224 mm
Depth		99 mm	99 mm
Horizontal pitch (inkl. 5 mm)		2.6 Module units	2.6 Module units
<b>Electrical data</b>			
Nominal voltage AC		$U_0 / U_N$ 240 V	240 V
Maximum continuous operating voltage	L-N	$U_C$ 300 V AC	300 V AC
	N-PE	$U_C$ 305 V AC	305 V AC
Max. discharge current (8/20) $\mu$ s	L-N / N-PE	$I_{max}$ 50 kA / 100 kA	50 kA / 100 kA
Nominal discharge current (8/20) $\mu$ s	L-N / N-PE	$I_n$ 20 kA / 80 kA	20 kA / 80 kA
Impulse current (10/350) $\mu$ s	L-N / N-PE	$I_{imp}$ 7.5 kA / 30 kA	12.5 kA / 30 kA
Short-circuit current rating (AC)	L-N / N-PE	$I_{SCCR}$ 25 kA	25 kA
Open Circuit Voltage of Combination Wave Generator		$U_{OC}$ 6 kV	6 kV
Voltage protection level	L-N / N-PE	$U_p$ 1500 V / 1500 V	1500 V / 1500 V
Follow Current Interrupt Rating	N-PE	$I_{fi}$ 100 A <sub>RMS</sub>	100 A <sub>RMS</sub>
Responding time	L-N / N-PE	$t_a$ < 100 ns / < 100 ns	< 100 ns / < 100 ns
Overcurrent protection (max)		315 A gG	315 A gG
TOV Withstand 120 min.	L-N	$U_T$ 442 V	442 V
TOV Withstand 200 ms	N-PE	$U_T$ 1200 V	1200 V
Number of ports		1	1
Leakage current		$I_{pE}$ ≤ 5 $\mu$ A	≤ 5 $\mu$ A
<b>Connection data</b>			
<b>Connection method</b>		<b>Screw terminal blocks</b>	<b>Screw terminal blocks</b>
Conductor cross section (max.)			
solid, stranded		35 mm <sup>2</sup>	35 mm <sup>2</sup>
flexible		25 mm <sup>2</sup>	25 mm <sup>2</sup>
Stripping length		18 mm	18 mm
Tightening torque		4.5 Nm	4.5 Nm
<b>Additional supply terminal (LA)</b>			
Rated load current of integrated supply terminal		$I_n$ 6.3 A	6.3 A
Back-up fuse 5 x 20 mm		FF 6.3 A	6.3 A
Wire connection method		Push-In	Push-In
Conductor cross section (max.)			
solid, stranded, flexible		10 AWG, 4 mm <sup>2</sup>	10 AWG, 4 mm <sup>2</sup>

# 1.6

## Surge Protection

xPole

Combined class 1/2/3 tested SPD for 40 mm busbar, SPZ

### Connection diagram

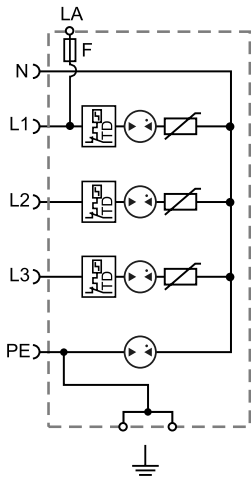

### Dimensions (mm)

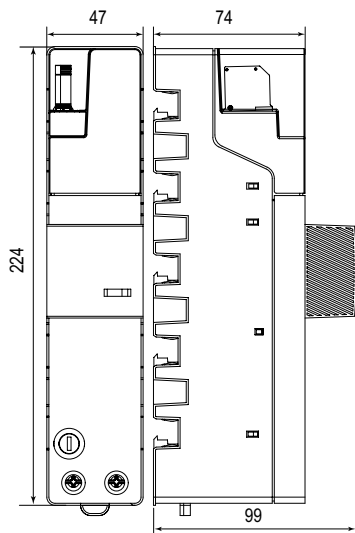

WA\_REN\_SG\_00422



## Description

- Combined class 1/2/3 tested SPD
- Intended to be used within meter boards according to VDE 0100-443/-534
- Narrowest design with highest functionality for the 40 mm busbar in only 2 modular units
- To be placed in an Eaton ZSD for a complete solution

## Types

### SPZ „H“

- Higher limp rating of 12,5 kA
- To be used in applications with an external lightning protection system (LPS III/IV)

### SPZ „NPE“

- Suitable for TT and TN-S systems due to the 3+1 connection
- Also available as “H” types with higher limp rating

### SPZ „OS“

- SPD without fused outgoing supply
- “H”-Types offer improved impulse surge capabilities limp of 12.5 kA

### Surge Protection SPZT123 Schmal - Ohne Sicherung (S-OS)

The SPZT123 surge protection from Eaton is intended in particular for installations in buildings in accordance with VDE 0100-443/-534. The installation is plug-in on the 40 mm busbar of the meter distribution board in the mains-side connection compartment (NAR). Neither screws nor tools are required for installation. A corresponding housing design prevents incorrect positioning and automatically adapts to the 5 mm or 10 mm busbar.

Poles Type	Max. Continuous Operating Voltage $U_c$	Type Designation	Article No.	Units per package
------------	--	---------------------	-------------	----------------------

### Combined Surge Protective Device SPZT123-300/3+NPE-(H)-S-OS

- for TT /TN-S

WA\_REN\_SG\_00422



3pole+NPE	300 VAC	SPZT123-300/3+NPE-S-OS	501041	1
		SPZT123-300/3+NPE-H-S-OS	501042	1

**Description Surge Protective Class T1/T2/T3 for Busbar mounting (40 mm), SPZT123-300/3+NPE(-H)-S-OS**

- Ready-to-connect Combined Surge Protection Device Type 1/2/3 on the basis of hybrid arrester
- For mounting on 40 mm busbar
- Field of application:  
For the protection of low voltage distribution systems against transient overvoltage caused by direct and indirect lightning stroke and switching operations
- Lightning protection classes III and IV according to IEC 62305
- Meets all requirements for installing surge protection according to DIN VDE 0100-534
- For TT & TN-S grid type

**Technical Data**

		SPZT123-300/3+NPE-S-OS	SPZT123-300/3+NPE-H-S-OS
<b>General data</b>			
Standards/regulations		IEC 61643-11 2011, EN 61643-11: 2012+A11: 2018	IEC 61643-11 2011, EN 61643-11: 2012+A11: 2018
IEC-Testklassifizierung		<b>T1</b> / <b>T2</b> / <b>T3</b>	<b>T1</b> / <b>T2</b> /
EN type		T1 / T2 / T3	T1 / T2 / T3
Number of ports		1	1
SPD design		Hybrid	Hybrid
Mode of protection		L-N, N-PE	L-N, N-PE
Mounting type		40 mm busbar	40 mm busbar
Surge protection fault message		visual	visual
Color		Light grey RAL 7035	Light grey RAL 7035
Housing material		Thermoplastic	Thermoplastic
Flammability rating according to UL 94		V-0	V-0
Degree of protection		IP20 / IP40 in combination with cover	IP20 / IP40 in combination with cover
Ambient temperature (operation)		-40 °C ... 85 °C	-40 °C ... 85 °C
Ambient temperature (storage/transport)		-40 °C ... 85 °C	-40 °C ... 85 °C
Permissible humidity (operation)		5 % ... 95 %	5 % ... 95 %
Altitude		≤ 4000 m (amsl (above mean sea level))	≤ 4000 m (amsl (above mean sea level))
Width		38 mm	38 mm
Height		233.4 mm	234.4 mm
Depth		102.3 mm	102.3 mm
Horizontal pitch (inkl. 5 mm)		2 Module units	2 Module units
<b>Electrical data</b>			
Nominal voltage AC		$U_0 / U_N$ 240 V	240 V
Maximum continuous operating voltage	L-N	$U_C$ 300 V AC	300 V AC
	N-PE	$U_C$ 305 V AC	305 V AC
Max. discharge current (8/20) $\mu$ s	L-N / N-PE	$I_{max}$ 40 kA / 100 kA	40 kA / 100 kA
Nominal discharge current (8/20) $\mu$ s	L-N / N-PE	$I_n$ 20 kA / 80 kA	20 kA / 80 kA
Impulse current (10/350) $\mu$ s	L-N / N-PE	$I_{imp}$ 7.5 kA / 30 kA	12.5 kA / 50 kA
Short-circuit current rating (AC)	L-N / N-PE	$I_{SCCR}$ 25 kA	25 kA
Open Circuit Voltage of Combination Wave Generator		$U_{OC}$ 6 kV	6 kV
Voltage protection level	L-N / N-PE	$U_p$ 1500 V / 1500 V	1500 V / 1500 V
Follow Current Interrupt Rating	N-PE	$I_{fi}$ 100 A <sub>RMS</sub>	100 A <sub>RMS</sub>
Responding time	L-N / N-PE	$t_a$ < 100 ns / < 100 ns	< 100 ns / < 100 ns
Overcurrent protection (max)		315 A gG	160 A gG
TOV Withstand 120 min.	L-N	$U_T$ 442 V	442 V
TOV Withstand 200 ms	N-PE	$U_T$ 1200 V	1200 V
Number of ports		1	1
Leakage current		$I_{pE}$ ≤ 5 $\mu$ A	≤ 5 $\mu$ A
<b>Connection data</b>			
<b>Connection method</b>		<b>Screw terminal blocks</b>	<b>Screw terminal blocks</b>
Conductor cross section (max.)			
solid, stranded		35 mm <sup>2</sup>	35 mm <sup>2</sup>
flexible		25 mm <sup>2</sup>	25 mm <sup>2</sup>
Stripping length		18 mm	18 mm
Tightening torque		4.5 Nm	4.5 Nm

# 1.10

## Surge Protection

xPole

Combined class 1/2/3 tested SPD without fused supply for 40 mm busbar, SPZ

### Connection diagram

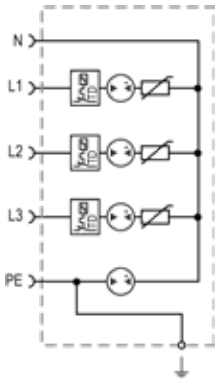

### Dimensions (mm)

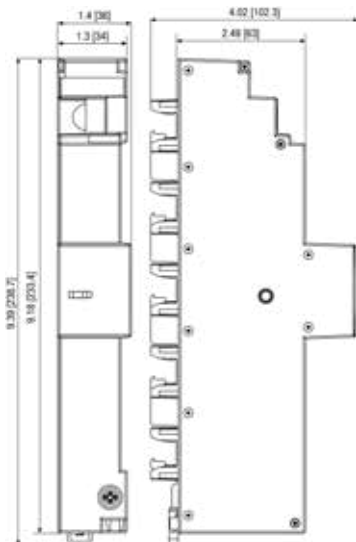

WA\_REN\_SG\_00122



## Description

- Combined class 1/2/3 tested SPD
- Intended to be used within meter boards according to VDE 0100-443/-534
- Fulfils the requirement of VDE-AR-N 4100 Chapter 7.8.2 for the power supply of an intelligent metering device from the mains-side connection compartment (NAR)
- Narrowest design with highest functionality for the 40 mm busbar in only 2 modular units
- To be placed in an Eaton ZSD for a complete solution

## Types

### SPZ „H“

- Higher limp rating of 12,5 kA
- To be used in applications with an external lightning protection system (LPS III/IV)

### SPZ „NPE“

- Suitable for TT and TN-S systems due to the 3+1 connection
- Also available as “H” types with higher limp rating

### Surge Protection SPZT123 Schmal - Sicherung (-S)

The SPZT123 surge protection from Eaton is particularly intended for installations in buildings in accordance with VDE 0100-443/-534. It can be plugged into the 40 mm busbar of the meter distribution board (ZSD). The innovative phase tap saves costs and space: The SPZT123 can provide the power supply for a gateway and the APZ space via its phase tap without the need for an extra extension of the busbar system for a separate phase tap. Neither screws nor tools are required for installation. An appropriate housing design prevents incorrect positioning and automatically adapts to the 5 mm or 10 mm busbar.

Poles Type	Max. Continuous Operating Voltage $U_c$	Type Designation	Article No.	Units per package
------------	--	---------------------	-------------	----------------------

#### Combined Surge Protective Device SPZT123-300/3+NPE-(H)-S

- for TT /TN-S

WA\_REN\_SG\_00122



3pole+NPE	300 VAC	SPZT123-300/3+NPE-S	501043	1
		SPZT123-300/3+NPE-H-S	501044	1

#### Combined Surge Protective Device SPZT123-300-(H)-S

- for TN-C

WA\_REN\_SG\_00522



3pole	300 VAC	SPZT123-300/3-S	501045	1
		SPZT123-300/3-H-S	501046	1



**Description Surge Protective Class T1/T2/T3 for Busbar mounting (40 mm), SPZT123-300-(H)-S**

- Ready-to-connect Combined Surge Protection Device Type 1/2/3 on the basis of hybrid arrester
- Field of application:  
For the protection of low voltage distribution systems against transient overvoltage caused by direct and indirect lightning stroke and switching operations
- Lightning protection classes III and IV according to IEC 62305
- Meets all requirements for installing surge protection according to DIN VDE 0100-534
- For TN-C grid type

**Technical Data**

	SPZT123-300/3-S	SPZT123-300/3-H-S
<b>General data</b>		
Standards/regulations	IEC 61643-11 2011, EN 61643-11: 2012+A11: 2018	IEC 61643-11 2011, EN 61643-11: 2012+A11: 2018
IEC-Testklassifizierung	<b>T1</b> / <b>T2</b> / <b>T3</b>	<b>T1</b> / <b>T2</b> / <b>T3</b>
EN type	T1 / T2 / T3	T1 / T2 / T3
Number of ports	1	1
SPD design	Hybrid	Hybrid
Mode of protection	L-PEN	L-PEN
Mounting type	40 mm busbar	40 mm busbar
Surge protection fault message	visual	visual
Color	Light grey RAL 7035	Light grey RAL 7035
Housing material	Thermoplastic	Thermoplastic
Flammability rating according to UL 94	V-0	V-0
Degree of protection	IP20 / IP40 in combination with cover	IP20 / IP40 in combination with cover
Ambient temperature (operation)	-40 °C ... 85 °C	-40 °C ... 85 °C
Ambient temperature (storage/transport)	-40 °C ... 85 °C	-40 °C ... 85 °C
Permissible humidity (operation)	5 % ... 95 %	5 % ... 95 %
Altitude	≤ 4000 m (amsl (above mean sea level))	≤ 4000 m (amsl (above mean sea level))
Width	36 mm	36 mm
Height	233.4 mm	233.4 mm
Depth	102.3 mm	102.3 mm
Horizontal pitch (incl. 5 mm)	2 Module units	2 Module units
<b>Electrical data</b>		
Nominal voltage AC	$U_o / U_N$ 240 V	240 V
Maximum continuous operating voltage	$U_C$ 300 V AC	300 V AC
Max. discharge current (8/20) $\mu$ s	$I_{max}$ 50 kA	50 kA
Nominal discharge current (8/20) $\mu$ s	$I_n$ 40 kA	40 kA
Impulse current (10/350) $\mu$ s	$I_{imp}$ 7.5 kA	12.5 kA
Short-circuit current rating (AC)	$I_{SCCR}$ 25 kA	25 kA
Open Circuit Voltage of Combination Wave Generator	$U_{OC}$ 6 kV	6 kV
Voltage protection level	$U_p$ 1500 V	1500 V
Responding time	$t_a$ < 100 ns	< 100 ns
TOV behavior at $U_T$	442 V	442 V
Max. backup fuse	160 A (gG)	160 A (gG)
Number of ports	1	1

# 1.14

## Surge Protection

xPole

Combined class 1/2/3 tested SPD with a fused supply for 40 mm busbar, SPZ

	SPZT123-300/3-S	SPZT123-300/3-H-S
<b>Technical Data</b>		
<b>Connection method</b>	<b>Screw terminal blocks</b>	<b>Screw terminal blocks</b>
Conductor cross section (max.) solid, stranded	2 AWG, 35 mm <sup>2</sup>	2 AWG, 35 mm <sup>2</sup>
flexible	4 AWG, 25 mm <sup>2</sup>	4 AWG, 25 mm <sup>2</sup>
Stripping length	18 mm	18 mm
Tightening torque	4.5 Nm	4.5 Nm
<b>Additional supply terminal (LA)</b>		
Rated current integrierter Abgang	I <sub>n</sub> 6.3 A	6.3 A
Back-up fuse 5 x 20 mm	FF 6.3 A	6.3 A
Wire connection method	2x Push-In	2x Push-In
Conductor cross section (max.) solid, stranded, flexible	14 AWG, 2.5 mm <sup>2</sup>	14 AWG, 2.5 mm <sup>2</sup>

### Connection diagram

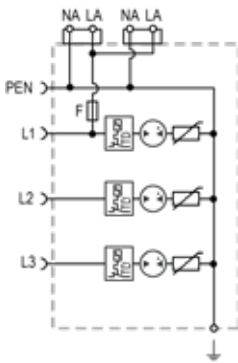

### Dimensions (mm)

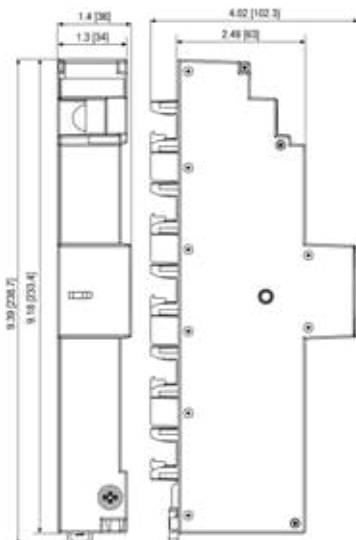

**Description Surge Protective Class T1/T2/T3 for Busbar mounting (40 mm), SPZT123-300/3+NPE(-H)-S-OS**

- Ready-to-connect Combined Surge Protection Device Type 1/2/3 on the basis of hybrid arrester
- For mounting on 40 mm busbar
- Field of application:  
For the protection of low voltage distribution systems against transient overvoltage caused by direct and indirect lightning stroke and switching operations
- Lightning protection classes III and IV according to IEC 62305
- Meets all requirements for installing surge protection according to DIN VDE 0100-534
- For TT & TN-S grid type

**Technical Data**

		SPZT123-300/3+NPE-S	SPZT123-300/3+NPE-H-S
<b>General data</b>			
Standards/regulations		IEC 61643-11 2011, EN 61643-11: 2012+A11: 2018	IEC 61643-11 2011, EN 61643-11: 2012+A11: 2018
IEC-Testklassifizierung		<b>T1</b> / <b>T2</b> / <b>T3</b>	<b>T1</b> / <b>T2</b> / <b>T3</b>
EN type		T1 / T2 / T3	T1 / T2 / T3
Number of ports		1	1
SPD design		Hybrid	Hybrid
Mode of protection		L-N, N-PE	L-N, N-PE
Mounting type		40 mm busbar	40 mm busbar
Surge protection fault message		visual	visual
Color		Light grey RAL 7035	Light grey RAL 7035
Housing material		Thermoplastic	Thermoplastic
Flammability rating according to UL 94		V-0	V-0
Degree of protection		IP20 / IP40 in combination with cover	IP20 / IP40 in combination with cover
Ambient temperature (operation)		-40 °C ... 85 °C	-40 °C ... 85 °C
Ambient temperature (storage/transport)		-40 °C ... 85 °C	-40 °C ... 85 °C
Permissible humidity (operation)		5 % ... 95 %	5 % ... 95 %
Altitude		≤ 4000 m (amsl (above mean sea level))	≤ 4000 m (amsl (above mean sea level))
Width		38 mm	38 mm
Height		233.4 mm	234.4 mm
Depth		102.3 mm	102.3 mm
Horizontal pitch (inkl. 5 mm)		2 Module units	2 Module units
<b>Electrical data</b>			
Nominal voltage AC		$U_0 / U_N$ 240 V	240 V
Maximum continuous operating voltage	L-N	$U_C$ 300 V AC	300 V AC
	N-PE	$U_C$ 305 V AC	305 V AC
Max. discharge current (8/20) $\mu$ s	L-N / N-PE	$I_{max}$ 40 kA / 100 kA	40 kA / 100 kA
Nominal discharge current (8/20) $\mu$ s	L-N / N-PE	$I_n$ 20 kA / 80 kA	20 kA / 80 kA
Impulse current (10/350) $\mu$ s	L-N / N-PE	$I_{imp}$ 7.5 kA / 30 kA	12.5 kA / 50 kA
Short-circuit current rating (AC)	L-N / N-PE	$I_{SCCR}$ 25 kA	25 kA
Open Circuit Voltage of Combination Wave Generator		$U_{OC}$ 6 kV	6 kV
Voltage protection level	L-N / N-PE	$U_p$ 1500 V / 1500 V	1500 V / 1500 V
Follow Current Interrupt Rating	N-PE	$I_{fi}$ 100 A <sub>RMS</sub>	100 A <sub>RMS</sub>
Responding time	L-N / N-PE	$t_a$ < 100 ns / < 100 ns	< 100 ns / < 100 ns
Overcurrent protection (max)		315 A gG	160 A gG
TOV Withstand 120 min.	L-N	$U_T$ 442 V	442 V
TOV Withstand 200 ms	N-PE	$U_T$ 1200 V	1200 V
Number of ports		1	1
Leakage current		$I_{pE}$ ≤ 5 $\mu$ A	≤ 5 $\mu$ A
<b>Connection data</b>			
<b>Connection method</b>		<b>Screw terminal blocks</b>	<b>Screw terminal blocks</b>
Conductor cross section (max.)			
solid, stranded		35 mm <sup>2</sup>	35 mm <sup>2</sup>
flexible		25 mm <sup>2</sup>	25 mm <sup>2</sup>
Stripping length		18 mm	18 mm
Tightening torque		4.5 Nm	4.5 Nm

# 1.16

## Surge Protection

xPole

Combined class 1/2/3 tested SPD with a fused supply for 40 mm busbar, SPZ

	SPZT123-300/3-S	SPZT123-300/3-H-S
<b>Technical Data</b>		
<b>Connection method</b>		
<b>Conductor cross section (max.)</b>		
solid, stranded	2 AWG, 35 mm <sup>2</sup>	2 AWG, 35 mm <sup>2</sup>
flexible	4 AWG, 25 mm <sup>2</sup>	4 AWG, 25 mm <sup>2</sup>
Stripping length	18 mm	18 mm
Tightening torque	4.5 Nm	4.5 Nm
<b>Additional supply terminal (LA)</b>		
Rated current integrierter Abgang	I <sub>n</sub> 6.3 A	6.3 A
Back-up fuse 5 x 20 mm	FF 6.3 A	6.3 A
Wire connection method	2x Push-In	2x Push-In
<b>Conductor cross section (max.)</b>		
solid, stranded, flexible	14 AWG, 2.5 mm <sup>2</sup>	14 AWG, 2.5 mm <sup>2</sup>

### Connection diagram

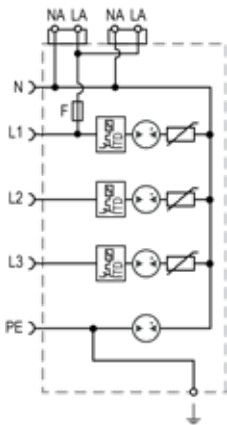

### Dimensions (mm)

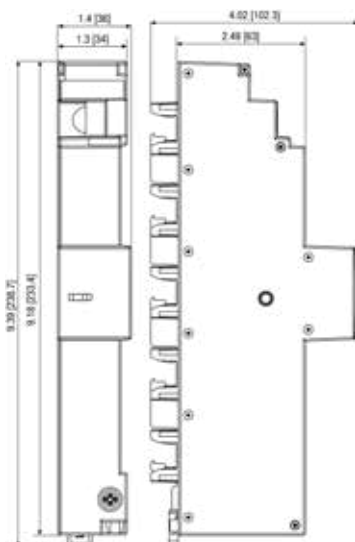

sg04518\_r



## Description

- Combined class 1/2 tested SPD
- Suitable for critical infrastructure which is fitted with an external lightning protection system
- Integrated auxiliary contact to provide the status of the SPD
- Double terminal offers the possibility to connect the SPD in series to the installation

## Types

### SPR „AX“

- Base, insert and auxiliary contact in one device
- Iimp of 25 kA per phase
- Suitable for applications with external lightning protection system (LPS I/II/III/IV)

### SPR „NPE“

- Suitable for TT and TN-S systems due to the 3+1 connection
- Galvanic separated SPD path between neutral and protective earth

Poles	Max. Continuous Operating Voltage $U_c$	Type Designation	Article No.	Units per package
-------	--	---------------------	-------------	----------------------

### Combined Surge Protective Device SPRT12-350

- incl. FM contact (change-over contact)
- for TN-C

sg04518\_r



3pole	350 VAC	SPRT12-350/3-AX	195235	1
-------	---------	-----------------	--------	---

- incl. FM contact (change-over contact)
- for TN-S/TT

sg04418\_r



3pole+NPE	350 VAC	SPRT12-350/3+NPE-AX	195236	1
-----------	---------	---------------------	--------	---

Range of protection	Max. Continuous Operating Voltage $U_c$	Type Designation	Article No.	Units per package
---------------------	--	---------------------	-------------	----------------------

### Insert for SPRT12-350

sg04318\_r



L-N / L-PEN	350 VAC	SPRT12-350	195237	1
N-PE	350 VAC	SPRT12-350/NPE	195238	1

## Description Surge Protective Class T1/T2

- Ready-to-connect Combined Surge Protection Device Type 1/2 on the basis of spark gaps
- Consisting of the base unit and plug-type modules
- Scope of application:  
To protect consumer systems against transient overvoltages caused by direct and indirect lightning strikes, as well as switching operations
- Lightning protection class I and II according to IEC 62305

## Technical Data

	SPRT12-350/3-AX	SPRT12-350/3+NPE-AX
<b>General data</b>		
Standards/regulations	IEC 61643-11, EN 61643-11	IEC 61643-11, EN 61643-11
IEC test classification	$\overline{T1}$ / $\overline{T2}$	$\overline{T1}$ / $\overline{T2}$
EN type	T1 / T2	T1 / T2
Number of ports	One	One
SPD design	Voltage-switching type	Voltage-switching type
Mode of protection	L-PEN	L-N, L-PE, N-PE
Mounting type	DIN rail 35 mm	DIN rail 35 mm
Surge protection fault message	Optical, remote indicator contact	Optical, remote indicator contact
Color	Light grey RAL 7035	Light grey RAL 7035
Insulating material	PBT-FR	PBT-FR
Housing material	PBT-FR	PBT-FR
Air clearances and creepage distances (according to EN 60664-1 and EN 61643-11)		
Degree of pollution	2	2
Overvoltage category	III	III
Material group	I	I
CTI value of material	≥ 600	≥ 600
$U_{max}$	< 2 kV	< 2 kV
Flammability rating according to UL 94	V-0	V-0
Degree of protection	IP20 (only when all terminal points are used)	IP20 (only when all terminal points are used)
Shock (operation)	30 g (Half-sine / 11 ms / 3x ±X, ±Y, ±Z)	30 g (Half-sine / 11 ms / 3x ±X, ±Y, ±Z)
Vibration (operation)	5 g (5 - 500 Hz/2.5 h/X, Y, Z)	5 g (5 - 500 Hz/2.5 h/X, Y, Z)
Ambient temperature (operation)	-40 °C ... 80 °C	-40 °C ... 80 °C
Ambient temperature (storage/transport)	-40 °C ... 80 °C	-40 °C ... 80 °C
Permissible humidity (operation)	5 % ... 95 %	5 % ... 95 %
Altitude	≤ 2000 m (amsl (above mean sea level))	≤ 2000 m (amsl (above mean sea level))
Width	106.8 mm	142.4 mm
Height	97 mm	95 mm
Depth	71.2 mm (incl. DIN rail 7.5 mm)	71.2 mm (incl. DIN rail 7.5 mm)
Horizontal pitch	6 Module units	8 Module units
<b>Electrical data</b>		
Nominal voltage	$U_N$ 240/415 V AC (TN-C)	240/415 V AC (TN-S) 240/415 V AC (TT)
Nominal frequency	$f_N$ 50 Hz	50 Hz
Maximum continuous operating voltage	$U_C$ 350 V AC	350 V AC
Reference test voltage	$U_{REF}$ 264 V AC	264 V AC
Rated load current	$I_L$ 125 A (< 55 °C)	125 A (< 55 °C)
Nominal discharge current (8/20) μs	$I_n$	
(L-PEN)	25 kA	-
(L-N)	-	25 kA
(L-PE)	-	25 kA
(N-PE)	-	100 kA
Maximum discharge current (8/20) μs	$I_{max}$	
(L-PEN)	50 kA	-
(L-N)	-	50 kA
(L-PE)	-	50 kA
Impulse discharge current (10/350) μs		
Peak value	$I_{imp}$ 25 kA (L-PEN)	25 kA (L-N)
Impulse discharge current (10/350) μs (L-PE)		
Peak value	$I_{imp}$ -	25 kA

	<b>SPRT12-350/3-AX</b>	<b>SPRT12-350/3+NPE-AX</b>
Impulse discharge current (10/350) $\mu$ s (N-PE)		
Peak value	$I_{imp}$ -	100 kA
Total discharge current (10/350) $\mu$ s	$I_{total}$ 75 kA	100 kA
Follow current interrupt rating	$I_{fi}$	
(L-PEN)	50 kA	-
(L-N)	-	50 kA
(N-PE)	-	100 A
Short-circuit current rating	$I_{SCCR}$ 50 kA	50 kA
Voltage protection level	$U_p$	
(L-PEN)	$\leq 1.5$ kV	-
(L-N)	-	$\leq 1.5$ kV
(L-PE)	-	$\leq 2.5$ kV
(N-PE)	-	$\leq 1.5$ kV
Residual voltage	$U_{res}$	
(L-PEN)	$\leq 1.5$ kV (at $I_n$ )	-
(L-N)	-	$\leq 1.5$ kV (at $I_n$ )
(L-PE)	-	$\leq 2.5$ kV (at $I_n$ )
(N-PE)	-	$\leq 1.5$ kV (at $I_n$ )
Front of wave sparkover voltage at 6 kV (1.2/50) $\mu$ s		
(L-PEN)	$\leq 1.5$ kV	-
(L-N)	-	$\leq 1.5$ kV
(L-PE)	-	$\leq 2.5$ kV
(N-PE)	-	$\leq 1.5$ kV
TOV behavior at $U_T$		
(L-PEN)	415 V AC (5 s / withstand mode) 457 V AC (120 min / withstand mode)	-
(L-N)	-	415 V AC (5 s / withstand mode) 457 V AC (120 min / withstand mode)
(N-PE)	-	1200 V AC (200 ms / withstand mode)
Response time	$t_A$ $\leq 100$ ns	$\leq 100$ ns
Current tripping factor	k 1.6	1.6
Max. backup fuse with branch wiring	315 A (gG)	315 A (gG)
Max. backup fuse with V-type through wiring (at 35 mm <sup>2</sup> )	125 A (gG)	125 A (gG)
<b>Additional technical data</b>		
Follow current interrupt rating	$I_{fi}$ 100 kA (264 V AC)	100 kA (264 V AC) (L-N)
Short-circuit current rating	$I_{SCCR}$ 100 kA (264 V AC)	100 kA (264 V AC)
<b>Remote signaling</b>		
Connection name	Remote fault indicator contact	Remote fault indicator contact
Switching function	PDT contact	PDT contact
Connection method	Plug-in/screw connection via COMBICON	Plug-in/screw connection via COMBICON
Operating voltage	12 V AC ... 250 V AC 125 V DC (200 mA DC)	12 V AC ... 250 V AC 125 V DC (200 mA DC)
Operating current	10 mA AC ... 1 A AC 1 A DC (30 V DC)	10 mA AC ... 1 A AC 1 A DC (30 V DC)
Screw thread	M2	M2
Conductor cross section		
flexible	0.14 mm <sup>2</sup> ... 1.5 mm <sup>2</sup>	0.14 mm <sup>2</sup> ... 1.5 mm <sup>2</sup>
solid	0.14 mm <sup>2</sup> ... 1.5 mm <sup>2</sup>	0.14 mm <sup>2</sup> ... 1.5 mm <sup>2</sup>
AWG	28 ... 16	28 ... 16
Stripping length	7 mm	7 mm
Tightening torque	0.25 Nm	0.25 Nm
<b>Connection data</b>		
<b>Connection method</b>		
Screw thread	M5	M5
Connection technology	Biconnect terminal block	Biconnect terminal block
Conductor cross section		
flexible, solid	2.5 mm <sup>2</sup> ... 35 mm <sup>2</sup>	2.5 mm <sup>2</sup> ... 35 mm <sup>2</sup>
AWG	13 ... 2	13 ... 2
Stripping length	18 mm	18 mm
<b>Connection method</b>		
<b>Fork-type cable lug</b>		
Diameter	5 mm	5 mm
Conductor cross section flexible	1.5 mm <sup>2</sup> ... 16 mm <sup>2</sup>	1.5 mm <sup>2</sup> ... 16 mm <sup>2</sup>
Tightening torque	4.5 Nm	4.5 Nm



Circuit diagrams

SPRT12-350/3-AX

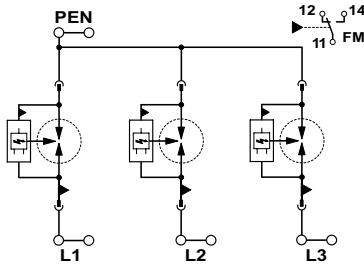

SPRT12-350/3+NPE-AX

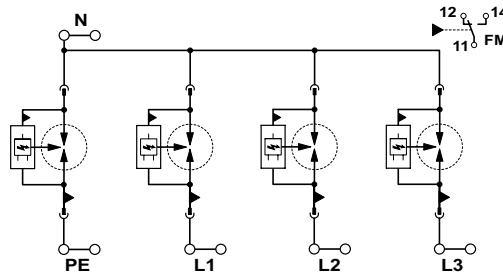

SPRT12-350, SPRT12-350/NPE

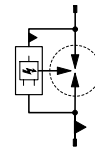

Dimensions (mm)

SPRT12-350/3-AX

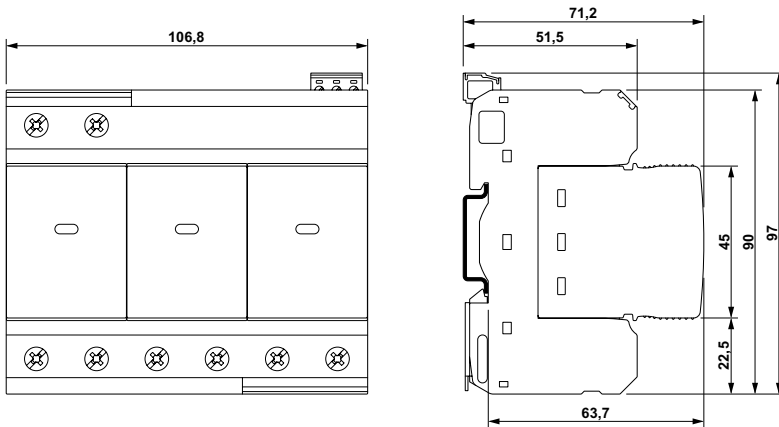

SPRT12-350/3+NPE-AX

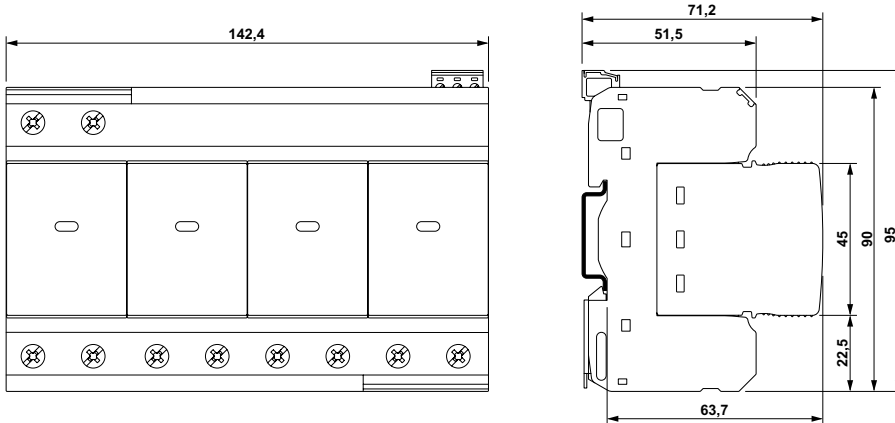

SPRT12-350, SPRT12-350/NPE

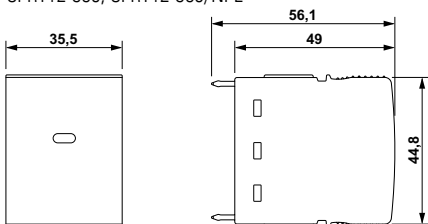

sg03316



## Description

- Combined test class 1/2 tested SPD
- Suitable for applications with an external lightning protection system (where also an Iimp of 12,5 kA per phase is needed)
- For TT, TN-C and TN-S supply systems
- Auxiliary contact and busbar available as an accessory

## Types

### SPB „BB“

- SPD which can be connected via busbar to a 4pole protective device/ switch disconnector

### SPB „NPE“

- Galvanic separated SPD path between neutral and protective earth
- Suitable for TT and TN-S systems due to the 3+1 connection

Description	Type Designation	Article No.	Units per package
-------------	---------------------	-------------	----------------------

**Lightning current arrester - surge arrester sets, Lightning protection classes III, IV**

sg28912



**Single phase supply / 2+0 connection**

TN-S-Set 2pole	SPBT12-280/2	158309	1 / 60
----------------	--------------	--------	--------

sg03216



**Single phase supply / 1+1 connection**

TN-S/TT Set 1+N Set 50kA	SPBT12-280-1+NPE50	184752	1 / 30
TN-S/TT-Set 1+1pole 100kA	SPBT12-280-1+NPE	158308	1 / 40

sg29612



**Three phase supply**

TN-C-Set 3pole (3+0 connection)	SPBT12-280/3	158330	1 / 40
TN-S-Set 4pole (4+0 connection)	SPBT12-280/4	158331	1 / 30

sg03316



**Three phase supply / 3+1 connection (50 kA)**

TN-S/TT Set 3+N Set	SPBT12-280-3+NPE50	184750	1 / 80
TN-S/TT Set 3+N Set with busbar	SPBT12-280-3+NPE50/BB	184751	1

sg65112



**Three phase supply / 3+1 connection (100 kA)**

TN-S/TT-Set 3+1pole	SPBT12-280-3+NPE	158332	1 / 20
TN-S/TT-Set 3+1pole with busbar	SPBT12-280-3+NPE/BB	158333	1

Description	Type Designation	Article No.	Units per package
-------------	------------------	-------------	-------------------

### Accessories

Auxiliary switch for SPBT12-280	ASAUWSC-SPM	131785	4/120
Busbar	ZV-KSBL...		

Impulse current $I_{imp}$ (10/350) $\mu$ s	Type Designation	Article No.	Units per package
---	------------------	-------------	-------------------

### Lightning current arrester - surge arrester SPBT12

#### Complete

12.5 kA L - (PE) N	SPBT12-280/1	158306	12/120
50 kA N-PE	SPBT12-NPE50	184749	1/60
100 kA N-PE	SPBT12-NPE100	158307	1/60

#### Insert

12.5 kA Insert	SPBT12-280	167341	2/120
----------------	------------	--------	-------

sg63312



**Description Surge Protective Class T1&T2**

- Field of application:  
For the protection of low voltage distribution systems against transient overvoltage caused by direct and indirect lightning stroke and switching operations
- Application according to IEC 60364-5-53 Clause 534
- Test class **I**, **II** according to IEC 61643-11
- SPD-type **T1**, **T2** according to EN 61643-11
- Lightning protection classes III and IV according to IEC 62305
- Busbars ZV-KSBI are available for all customary applications

**Technical Data**

		SPBT12-280...	SPBT12-NPE50	SPBT12-NPE100
<b>Electrical</b>	per pole			
Responding time (rate of voltage rise 5 kV/μs)		< 25 ns	< 100 ns	< 100 ns
Voltage protection level	$U_p$	≤ 1.5 kV	< 1.4 kV	< 1.5 kV
Voltage protection level at 5 kA (8/20) μs	$U_p$	950 V	–	–
Max. continuous operating voltage	$U_c$	280 VAC	260 VAC	255 VAC
TOV test value	$U_T$	335 VAC (5 s)	1200 VAC (200 ms)	1200 VAC (200 ms)
Rated frequency		50 Hz	50 Hz	50 Hz
Open circuit voltage	$U_{oc}$	10 kV	–	20 kV
Nominal discharge current (8/20) μs	$I_n$	25 kA	50 kA	100 kA
Max. discharge current	$I_{max}$	50 kA	100 kA	100 kA
Impulse current (10/350) μs	$I_{imp}$			
Peak current		12.5 kA	50 kA	100 kA
Follow current interrupt rating	$I_{fi}$	–	100 A <sub>r.m.s.</sub>	100 A <sub>r.m.s.</sub>
Maximum back-up fuse		160 AgL/gG	–	–
Maximum short-circuit current		50 kA <sub>r.m.s.</sub>	–	–

Connection diagram

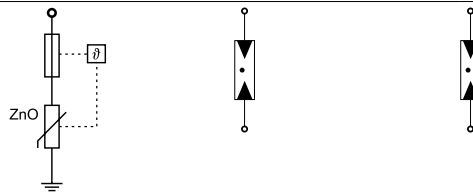

**Mechanical**

Frame size		45 mm	45 mm	45 mm
Device height		80 mm	80 mm	80 mm
Device width		17.5 mm	17.5 mm	35 mm
Weight		121 g	93 g	250 g
Permitted ambient temperature		-40°C to +70°C	-40°C to +70°C	-40°C to +70°C
Degree of protection		IP20	IP20	IP20
Upper and lower lift terminal capacity		4 - 25 mm <sup>2</sup>	top 4 - 50 mm <sup>2</sup> , bottom 4 - 35 mm <sup>2</sup>	4 - 35 mm <sup>2</sup>
Upper and lower open mouthed terminals for busbar thickness up to		1.5 mm	top - / bottom 1.5 mm	1.5 mm
Tightening torque of terminal screws		2.4 - 3 Nm	2.4 - 3 Nm	2.4 - 3 Nm
Quick fastening on DIN rail according to		IEC/EN 60715	IEC/EN 60715	IEC/EN 60715
Accessories: busbars 16 mm <sup>2</sup>		Type ZV-KSBI ...	Type ZV-KSBI ...	Type ZV-KSBI ...

**Dimensions (mm)**

SPBT12-280 SPBT12-NPE100  
SPBT12-NPE50

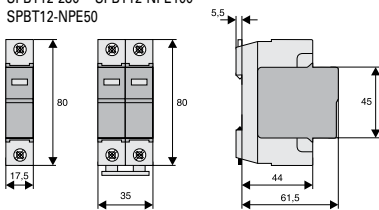

**Lightning current arrester - surge arrester sets, Lightning protection classes III, IV**

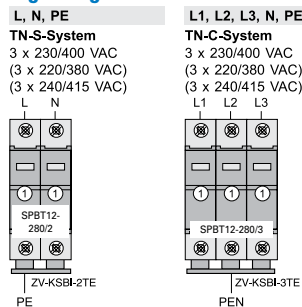

① ... SPBT12-280

### Technical Data

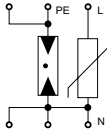
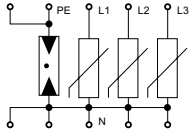
		<b>SPBT12-280-1+NPE50</b>	<b>SPBT12-280-3+NPE50</b>
<b>Electrical</b>			
		per pole	
Responding time (rate of voltage rise 5 kV/μs)	L-N / N-PE	< 25 ns / < 100 ns	< 25 ns / < 100 ns
Voltage protection level	L-N / L-PE / N-PE	$U_p$ < 1.5 kV	< 1.5 kV
Max. continuous operating voltage	L-N / N-PE	$U_c$ 280 VAC / 260 VAC	280 VAC / 260 VAC
TOV test value		$U_T$	
5 s	L-N / L-PE	348 VAC / 370 VAC	348 VAC / 370 VAC
200 ms	N-PE	1200 VAC	1200 VAC
Rated frequency		50/60 Hz	50/60 Hz
Open circuit voltage		$U_{oc}$ 10 kV	20 kV
Nominal discharge current (8/20) μs	L-N / N-PE	$I_n$ 25 kA / 50 kA	3x25 kA / 50 kA
Max. discharge current	L-N / N-PE	$I_{max}$ 50 kA / 100 kA	3x50 kA / 100 kA
Impulse current (10/350) μs		$I_{imp}$	
Peak current	L-N / N-PE	12.5 kA / 50 kA	3x12.5 kA / 50 kA
Follow current interrupt rating	N-PE	$I_{fi}$ 100 $A_{r.m.s.}$	100 $A_{r.m.s.}$
Maximum back-up fuse		—	—
Maximum short-circuit current		—	—
Connection diagram			

### Mechanical

Frame size		45 mm	45 mm
Device height		80 mm	80 mm
Device width		35 mm	70 mm
Weight		218 g	470 g
Permitted ambient temperature		-40°C to +70°C	-40°C to +70°C
Degree of protection (built-in)		IP40	IP40
Upper and lower lift terminal capacity			
L, N		4 - 25 mm <sup>2</sup>	4 - 25 mm <sup>2</sup>
N, PE		4 - 50 mm <sup>2</sup>	4 - 50 mm <sup>2</sup>
Upper and lower open mouthed terminals for busbar thickness up to		1.5 mm	1.5 mm
Tightening torque of terminal screws		2.4 - 3 Nm	2.4 - 3 Nm
Quick fastening on DIN rail according to		IEC/EN 60715	IEC/EN 60715
Accessories: busbars 16 mm <sup>2</sup>		Type ZV-KSBI ...	Type ZV-KSBI ...

### Lightning current arrester - surge arrester sets, Lightning protection classes III, IV

#### L, N, PE

**TN-S-System**  
 3 x 230/400 VAC  
 (3 x 220/380 VAC)  
 (3 x 240/415 VAC)

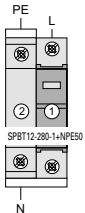

#### L1, L2, L3, N, PE

**TN-S/TT-System**  
 3 x 230/400 VAC  
 (3 x 220/380 VAC)  
 (3 x 240/415 VAC)

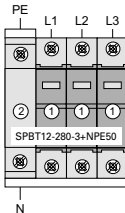

#### TN-S/TT-System

3 x 230/400 VAC  
 (3 x 220/380 VAC)  
 (3 x 240/415 VAC)

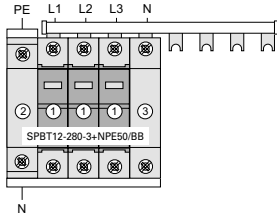

- ① ... SPBT12-280
- ② ... SPBT12-NPE50
- ③ ... ASLTT-63

Technical Data

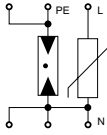
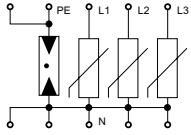
		SPBT12-280-1+NPE	SPBT12-280-3+NPE
<b>Electrical</b>			
		per pole	
Responding time (rate of voltage rise 5 kV/μs)	L-N / N-PE	< 25 ns / < 100 ns	< 25 ns / < 100 ns
Voltage protection level	L-N / L-PE / N-PE	$U_p$ < 1.5 kV	< 1.5 kV
Max. continuous operating voltage	L-N / N-PE	$U_C$ 280 VAC / 255 VAC	280 VAC / 255 VAC
TOV test value		$U_T$	
5 s	L-N / L-PE	348 VAC / 370 VAC	348 VAC / 370 VAC
200 ms	N-PE	1200 VAC	1200 VAC
Rated frequency		50 Hz	50 Hz
Open circuit voltage		$U_{oc}$ 10 kV	20 kV
Nominal discharge current (8/20) μs	L-N / N-PE	$I_n$ 25 kA / 100 kA	3x25 kA / 100 kA
Max. discharge current	L-N / N-PE	$I_{max}$ 50 kA / 100 kA	3x50 kA / 100 kA
Impulse current (10/350) μs		$I_{imp}$	
Peak current	L-N / N-PE	12.5 kA / 100 kA	3x12.5 kA / 100 kA
Follow current interrupt rating	N-PE	100 $A_{r.m.s.}$	100 $A_{r.m.s.}$
Maximum back-up fuse		160 AgL/gG	160 AgL/gG
Maximum short-circuit current		50 kA $I_{r.m.s.}$	50 kA $I_{r.m.s.}$
Connection diagram			
<b>Mechanical</b>			
Frame size		45 mm	45 mm
Device height		80 mm	80 mm
Device width		52.5 mm	87.5 mm
Weight		375 g	626 g
Permitted ambient temperature		-40°C to +70°C	-40°C to +70°C
Degree of protection (built-in)		IP40	IP40
Upper and lower lift terminal capacity			
L, N		4 - 25 mm <sup>2</sup>	4 - 25 mm <sup>2</sup>
N, PE		4 - 35 mm <sup>2</sup>	4 - 35 mm <sup>2</sup>
Upper and lower open mouthed terminals for busbar thickness up to		1.5 mm	1.5 mm
Tightening torque of terminal screws		2.4 - 3 Nm	2.4 - 3 Nm
Quick fastening on DIN rail according to		IEC/EN 60715	IEC/EN 60715
Accessories: busbars 16 mm <sup>2</sup>		Type ZV-KSBI ...	Type ZV-KSBI ...

Lightning current arrester - surge arrester sets, Lightning protection classes III, IV

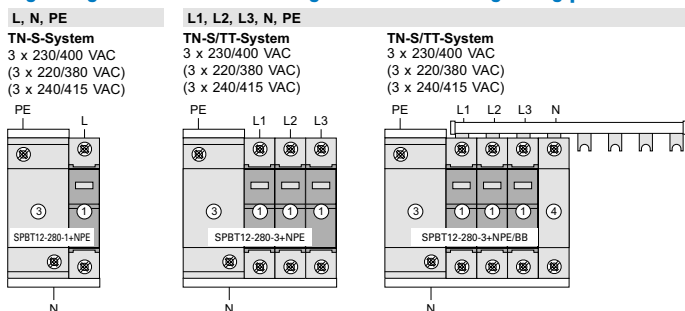

- ① ... SPBT12-280
- ② ... ASAXSC-SPM
- ③ ... SPBT12-NPE100
- ④ ... ASLTT-63

SG04913



## Description

- Class 2 tested SPD
- Suitable for applications without an external lightning protection system
- For TT, TN-C and TN-S supply systems
- Auxiliary contact and busbar available as an accessory
- SPCT 280 and 335 (inserts and combinations) are additional class 3 tested

## Types

### SPC „BB“

- SPD which can be connected via busbar to a 4pole protective device/switch disconnecter

### SPC „NPE“

- Galvanic separated SPD path between neutral and protective earth
- Suitable for TT and TN-S systems due to the 3+1 connection



Poles	Max. Continuous Operating Voltage $U_c$	$I_n$ (8/20) $\mu$ s	Type Designation	Article No.	Units per package
-------	---	----------------------	------------------	-------------	-------------------

**Plug-in surge arrester SPCT2**

sg04413



**Single phase supply / 1+0 connection**

1pole	280 VAC	20 kA	SPCT2-280/1	T3 tested	167593	12/120
1pole	335 VAC	20 kA	SPCT2-335/1	T3 tested	167598	12/120
1pole	385 VAC	20 kA	SPCT2-385/1		167603	12/120
1pole	460 VAC	20 kA	SPCT2-460/1		167608	12/120
1pole	580 VAC	20 kA	SPCT2-580/1		167613	12/120
1pole	260 VAC	40 kA	SPCT2-NPE60/1	T3 tested	167618	12/120

sg04613



**Single phase supply / 1+1 connection**

1+N	280 VAC	20 kA	SPCT2-280-1+NPE	T3 tested	167619	1/60
1+N	335 VAC	20 kA	SPCT2-335-1+NPE	T3 tested	167621	1/60
1+N	385 VAC	20 kA	SPCT2-385-1+NPE		167623	1/60
1+N	460 VAC	20 kA	SPCT2-460-1+NPE		167625	1/60
1+N	580 VAC	20 kA	SPCT2-580-1+NPE		167627	1/60

sg04613



**Single phase supply / 2+0 connection**

2pole	280 VAC	2x20 kA	SPCT2-280/2	T3 tested	167594	1/60
2pole	335 VAC	2x20 kA	SPCT2-335/2	T3 tested	167599	1/60
2pole	385 VAC	2x20 kA	SPCT2-385/2		167604	1/60
2pole	460 VAC	2x20 kA	SPCT2-460/2		167609	1/60
2pole	580 VAC	2x20 kA	SPCT2-580/2		167614	1/60

sg04713



**Three phase supply / 3+0 connection (TN-C)**

3pole	280 VAC	3x20 kA	SPCT2-280/3	T3 tested	167595	1/40
3pole	335 VAC	3x20 kA	SPCT2-335/3	T3 tested	167600	1/40
3pole	385 VAC	3x20 kA	SPCT2-385/3		167605	1/40
3pole	460 VAC	3x20 kA	SPCT2-460/3		167610	1/40
3pole	580 VAC	3x20 kA	SPCT2-580/3		167615	1/40

sg04913



**Three phase supply / 3+1 connection (TN-S/TT)**

3+N	280 VAC	20 kA	SPCT2-280-3+NPE	T3 tested	167620	1/30
3+N	335 VAC	20 kA	SPCT2-335-3+NPE	T3 tested	167622	1/30
3+N	385 VAC	20 kA	SPCT2-385-3+NPE		167624	1/30
3+N	460 VAC	20 kA	SPCT2-460-3+NPE		167626	1/30
3+N	580 VAC	20 kA	SPCT2-580-3+NPE		167628	1/30

sg06514



**Three phase supply / 3+1 connection with additional busbar**

3+N/BB	280 VAC	3x20 kA	SPCT2-280-3+NPE/BB	T3 tested	167629	1
3+N/BB	335 VAC	3x20 kA	SPCT2-335-3+NPE/BB	T3 tested	167630	1
3+N/BB	385 VAC	3x20 kA	SPCT2-385-3+NPE/BB		167631	1
3+N/BB	460 VAC	3x20 kA	SPCT2-460-3+NPE/BB		167632	1

sg04813



Poles	Max. Continuous Operating Voltage $U_c$	$I_n$ (8/20) $\mu$ s	Type Designation	Article No.	Units per package
<b>Three phase supply / 4+0 connection (TN-S)</b>					
4pole	280 VAC	4x20 kA	SPCT2-280/4	T3 tested 167596	1/30
4pole	335 VAC	4x20 kA	SPCT2-335/4	T3 tested 167601	1/30
4pole	385 VAC	4x20 kA	SPCT2-385/4	167606	1/30
4pole	460 VAC	4x20 kA	SPCT2-460/4	167611	1/30
4pole	580 VAC	4x20 kA	SPCT2-580/4	167616	1/30

sg08213



#### Plug-in surge arrester SPCT2. Insert

##### Insert (1pole/path)

Insert	280 VAC	20 kA	SPCT2-280	T3 tested 167592	2/120
Insert	335 VAC	20 kA	SPCT2-335	T3 tested 167597	2/120
Insert	385 VAC	20 kA	SPCT2-385	167602	2/120
Insert	460 VAC	20 kA	SPCT2-460	167607	2/120
Insert	580 VAC	20 kA	SPCT2-580	167612	2/120
Insert	260 VAC	40 kA	SPCT2-NPE60	167617	2/120



**Description Surge Protective Class T2**

- Field of application:  
For the protection of low voltage distribution systems against transient overvoltage caused by direct and indirect lightning stroke and switching operations
- Test class **[II]** according to IEC 61643-11
- SPD-type **[T2]** according to EN 61643-11
- Auxiliary switch ASAUXSC-SPM for remote message transmission can be mounted onto the device
- SPCT 280 and 335 are additional class 3 tested

**Technical Data**

Inserts		SPCT2-075	SPCT2-135	SPCT2-175	SPCT2-280	SPCT2-335	SPCT2-385	SPCT2-460
<b>Electrical</b>								
Mechanical coding		x	x	x	x	x	x	x
Responding time (rate of voltage rise 5 kV/μs)		< 25 ns	< 25 ns	< 25 ns	< 25 ns	< 25 ns	< 25 ns	< 25 ns
Voltage protection level at nominal discharge current / $U_{oc}$	$U_p$	< 750 V	< 900 V	< 1.0 kV	< 1.4 kV	< 1.5 kV	< 1.7 kV	< 1.9 kV
Voltage protection level at 5 kA (8/20) μs	$U_n$	400 V	550 V	700 V	1000 V	1200 V	1350 V	1700 V
Max. continuous operating voltage	$U_c$	75 VAC	135 VAC	175 VAC	280 VAC	335 VAC	385 VAC	460 VAC
TOV test value (5 s)	$U_T$	87 VAC	174 VAC	= $U_c$	348 VAC	348 VAC	348 VAC	580 VAC
Rated frequency		50 Hz	50 Hz	50 Hz	50 Hz	50 Hz	50 Hz	50 Hz
Open circuit voltage	$U_{oc}$	–	–	–	10 kV	5 kV	–	–
Nominal discharge current (8/20) μs	$I_n$	20 kA	20 kA	20 kA	20 kA	20 kA	20 kA	20 kA
Max. discharge current	$I_{max}$	30 kA	40 kA	40 kA	40 kA	40 kA	40 kA	40 kA
Follow current interrupt rating	$I_{fi}$	–	–	–	–	–	–	–
Open Circuit Voltage	$U_{oc}$ [T3]	–	–	–	6 kV	6 kV	–	–
Voltage protection level	$U_p$ [T3]	–	–	–	900 V	1000 V	–	–

Maximum back-up fuse  
Maximum short-circuit current

 ≤ 125 AgL 50 kA <sub>r.m.s.</sub>	 PLHT-C100 20 kA <sub>r.m.s.</sub>
--	---

Connection diagram

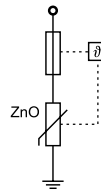

**Mechanical**

Frame size	45 mm
Device height	80 mm
Device width	
1pole	17.5 mm (1MU)
1+1pole, 2pole	35 mm (2MU)
3pole	52.5 mm (3TE)
3+1pole, 4pole	70 mm (4TE)
Mechanical coding	
1pole	x
1+1pole	yx
2pole	xx
3pole	xxx
3+1pole	yxxx
4pole	xxxx
Weight base 1P, 1+1P, 2P, 3P, 3+1P, 4P	53/120/120/180/240/240 g
Weight complete devices 1P, 1+1P, 2P, 3P, 3+1P, 4P	110/201/220/330/412/440 g
Permitted ambient temperature	-40°C to +70°C
Degree of protection	IP20
Upper and lower lift terminal capacity	4 - 25 mm <sup>2</sup>
Upper and lower open mouthed terminals for busbar thickness up to	1.5 mm
Tightening torque of terminal screws	2.4 - 3 Nm
Quick fastening on DIN rail according to	IEC/EN 60715
Accessories: busbars 16 mm <sup>2</sup>	Type ZV-KSBI ...

### Technical Data

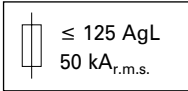
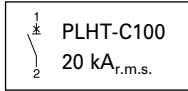
Inserts	SPCT2-580	SPCT2-NPE60
<b>Electrical</b>		
Mechanical coding	x	y
Responding time (rate of voltage rise 5 kV/ $\mu$ s)	< 25 ns	< 100 ns
Voltage protection level at nominal discharge current / $U_{oc}$	$U_p$ 2100 V	< 1.5 kV
Voltage protection level at 5 kA (8/20) $\mu$ s	$U_p$ 2000 V	–
Max. continuous operating voltage	$U_c$ 580 VAC	260 VAC
TOV test value	$U_T$ = $U_c$ (5 s)	1200 VAC (200 ms)
Rated frequency	50 Hz	50 Hz
Open circuit voltage	$U_{oc}$ –	6 kV
Nominal discharge current (8/20) $\mu$ s	$I_n$ 15 kA	40 kA
Max. discharge current	$I_{max}$ 40 kA	60 kA
Follow current interrupt rating	$I_{fi}$ –	100 A <sub>r.m.s.</sub>
Maximum back-up fuse		
Maximum short-circuit current		

Connection diagram



### Mechanical

Frame size	45 mm
Device height	80 mm
Device width	
1pole	17.5 mm (1MU)
1+1pole, 2pole	35 mm (2MU)
3pole	52.5 mm (3TE)
3+1pole, 4pole	70 mm (4TE)
<b>Mechanical coding</b>	
1pole	x
1+1pole	yx
2pole	xx
3pole	xxx
3+1pole	yxxx
4pole	xxxx
Weight base 1P, 1+1P, 2P, 3P, 3+1P, 4P	53/120/120/180/240/240 g
Weight complete devices 1P, 1+1P, 2P, 3P, 3+1P, 4P	110/201/220/330/412/440 g
Permitted ambient temperature	-40°C to +70°C
Degree of protection	IP20
Upper and lower lift terminal capacity	4 - 25 mm <sup>2</sup>
Upper and lower open mouthed terminals for busbar thickness up to	1.5 mm
Tightening torque of terminal screws	2.0 - 3 Nm
Quick fastening on DIN rail according to	IEC/EN 60715
Accessories: busbars 16 mm <sup>2</sup>	Type ZV-KSBI ...

### Dimensions (mm)

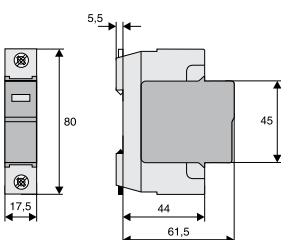

Technical Data

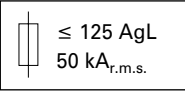
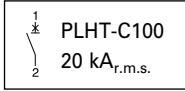
	SPCT2-1+NPE		SPCT2-3+NPE
<b>Electrical</b>			
Mechanical coding		yX	yxxx
Responding time (rate of voltage rise 5 kV/ $\mu$ s)	L-N/N-PE/L-PE	< 25ns/< 100ns/< 100ns	< 25ns/< 100ns/< 100ns
Max. continuous operating voltage	L-N/N-PE	$U_C$ 335VAC/260VAC	280VAC/260VAC
TOV test value		$U_T$	
5 s	L-N	415 VAC	350 VAC
200 ms	N-PE	1200 VAC	1200 VAC
Rated frequency		50 Hz	50 Hz
Nominal discharge current (8/20) $\mu$ s	L-N/N-PE/L-PE	$I_n$ 20 kA	20 kA
Voltage protection level at $I_n$	L-N/N-PE/L-PE	$U_D$ $\leq 1600V/\leq 1000V/\leq 1650V$	$\leq 1000V/\leq 1000V/\leq 1300V$
Max. discharge current (8/20) $\mu$ s	L-N/N-PE/L-PE	$I_{max}$ 40 kA	40 kA
Follow current interrupt rating	N-PE	$I_{fi}$ 100 $A_{r.m.s.}$	100 $A_{r.m.s.}$
Maximum back-up fuse			
Maximum short-circuit current	50 $kA_{r.m.s.}$		20 $kA_{r.m.s.}$

Connection diagram

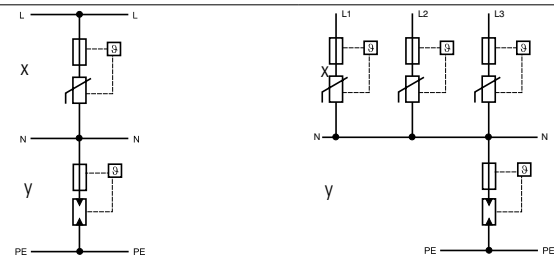

Mechanical

Mechanical coding of base	yX	yxxx
Frame size	45 mm	45 mm
Device height	80 mm	80 mm
Device width	35 mm	70 mm
Weight	201 g	412 g
Permitted ambient temperature	-40°C to +70°C	-40°C to +70°C
Degree of protection (built-in)	IP40	IP40
Upper and lower lift terminal capacity	1 - 25 mm <sup>2</sup>	1 - 25 mm <sup>2</sup>
Upper and lower open mouthed terminals for busbar thickness up to	1.5 mm	1.5 mm
Tightening torque of terminal screws	2.4 - 3 Nm	2.4 - 3 Nm
Quick fastening on DIN rail according to	IEC/EN 60715	IEC/EN 60715
Accessories: busbars 16 mm <sup>2</sup>	Type ZV-KSBI ...	Type ZV-KSBI ...

Dimensions (mm)

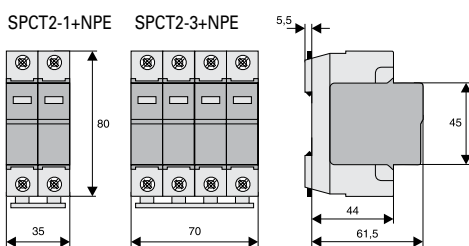

Application Examples

SPCT2-1+NPE

TN-, TT-System  
3 x 230/400 VAC  
3 x 240/415 VAC

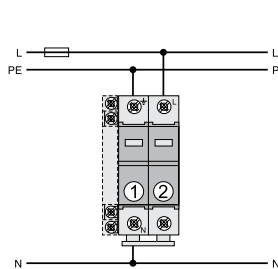

- ① ... SPCT2-NPE
- ② ... SPCT2-335

SPCT2-3+NPE

TN-S-, TT-System  
3 x 230/400 VAC  
3 x 240/415 VAC

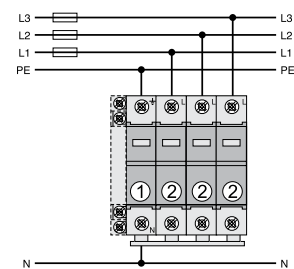

- ① ... SPCT2-NPE
- ② ... SPCT2-280

---

## Surge arrester Sets

---

### SPCT2 class 2/3 tested with pre-fitted busbar (BB)

---

#### Surge Arrester Set SPCT2-335-3+NPE/BB

- The 3+1 circuit offers a universal solution for surge protection in low voltage distribution systems
- Suitable for TT- and TN-S-systems according to IEC 60364-5-53 Clause 534
- Remote message transmission is possible by mounting auxiliary switch ASAXSC-SPM
- Busbar connected, minimum installation work required

---

#### Content

---

##### SPCT2-335-3+NPE/BB

- |                          |                       |
|--------------------------|-----------------------|
| - 1 unit SPCT2-335-3+NPE | Surge arrester        |
| - 1 unit ASLTT-63        | Lead-through terminal |
| - busbar included        |                       |
-

sg64812



## Description

- Test class 2 tested SPD
- Fulfills the minimum requirements for an application without external lightning protection system
- For TT, TN-C and TN-S supply systems
- Auxiliary contact and busbar available as an accessory

## Types

### SPE „NPE“

- Galvanic separated SPD path between neutral and protective earth
- Suitable for TT and TN-S systems due to the 3+1 connection

Poles	Max. Continuous Operating Voltage $U_c$	$I_n$ (8/20) $\mu$ s	Type Designation	Article No.	Units per package
-------	---	----------------------	------------------	-------------	-------------------

### Surge arrester SPET2, 1- to 4pole

SG64012



#### Single phase supply / 1+0 connection

1pole	280 VAC	10 kA	SPET2-280/1	168741	2/120
1pole	335 VAC	10 kA	SPET2-335/1	168695	2/120

#### Single phase supply / 1+1 connection

1pole+N	280 VAC	10 kA	SPET2-280/1+NPE	168699	1/60
1pole+N	335 VAC	10 kA	SPET2-335/1+NPE	168701	1/60

#### Single phase supply / 2+0 connection

2pole	280 VAC	2x10 kA	SPET2-280/2	168742	1/60
2pole	335 VAC	2x10 kA	SPET2-335/2	168696	1/60

SG64812



#### Three phase supply / 3+0 connection (TN-C)

3pole	280 VAC	3x10 kA	SPET2-280/3	168692	1/40
3pole	335 VAC	3x10 kA	SPET2-335/3	168697	1/40

#### Three phase supply / 3+1 connection (TN-S / TT)

3pole+N	280 VAC	10 kA	SPET2-280/3+NPE	168700	1/30
3pole+N	335 VAC	10 kA	SPET2-335/3+NPE	168702	1/30

#### Three phase supply / 4+0 connection (TN-S / TT)

4pole	280 VAC	4x10 kA	SPET2-280/4	168693	1/30
4pole	335 VAC	4x10 kA	SPET2-335/4	168698	1/30

### Surge arrester SPET2, Insert

sg63412



#### Insert (1pole/path)

Insert	280 VAC	10 kA	SPET2-280	168740	2/120
Insert	335 VAC	10 kA	SPET2-335	168694	2/120

### Accessories

SG63311



Auxiliary switch for SPBT12, SPCT2, SPET2, SPDT3	ASAUWSC-SPM	131785	8/80
--	-------------	--------	------

Description	Type Designation	Article No.	Units per package
-------------	------------------	-------------	-------------------

### Lead-through terminal for SPB, ASLTT-63

SG59511





Lead-through terminal	ASLTT-63	131784	12/120
-----------------------	----------	--------	--------



**Description Surge arrester SPET2**

- Field of application:  
For the protection of low voltage distribution systems against transient overvoltage caused by direct and indirect lightning stroke and switching operations
- Test class **II** according to IEC 61643-11
- SPD-type **T2**, according to EN 61643-11
- Busbars ZV-KSBI are available for all customary applications
- Suitable for busbar connection to all Xtra Combinations switchgear

**Technical Data**

	SPET2-280	SPET2-335	SPET2-NPE60
<b>Electrical</b>			
Responding time (rate of voltage rise 5 kV/μs)	< 25 ns	< 25 ns	< 100 ns
Voltage protection level at nominal discharge current	$U_p$ < 1.2kV	< 1.3kV	< 1.5 kV
Voltage protection level at 5 kA (8/20) μs	$U_p$ 1000 V	1200 V	-
Max. continuous operating voltage	$U_c$ 280 VAC	335 VAC	260 VAC
TOV test value (5 s)	$U_T$ 335 VAC	400 VAC	1200 VAC
Rated frequency	50 Hz	50 Hz	50 Hz
Nominal discharge current (8/20) μs	$I_n$ 10 kA	10 kA	40 kA
Max. discharge current	$I_{max}$ 20 kA	20 kA	60 kA
Follow current interrupt rating	$I_{fi}$ -	-	100 A <sub>r.m.s.</sub>
Maximum back-up fuse	 ≤ 125 AgL	 ≤ C63	
Maximum short-circuit current	50 kA <sub>r.m.s.</sub>	10 kA <sub>r.m.s.</sub>	

Connection diagram



**Mechanical**

Frame size	45 mm
Device height	80 mm
Device width	17.5 mm
Weight	87 g
Permitted ambient temperature	-40°C to +70°C
Degree of protection	IP20
Upper and lower lift terminal capacity	4 - 25 mm <sup>2</sup>
Upper and lower open mouthed terminals for busbar thickness up to	1.5 mm
Tightening torque of terminal screws	2.4 - 2.5 Nm
Quick fastening on DIN rail according to	IEC/EN 60715
Accessories: busbars 16 mm <sup>2</sup>	Type ZV-KSBI ...

**Dimensions (mm)**

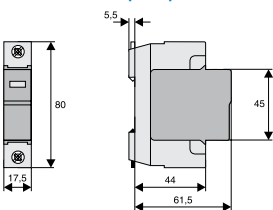

### Application Examples SPET2 according to IEC 60364-5-53 Clause 534

**TN-C-System**  
3 x 230/400 VAC  
(3 x 220/380 VAC)  
(3 x 240/415 VAC)

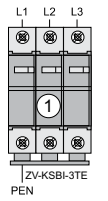

**TN-S-System**  
3 x 230/400 VAC  
(3 x 220/380 VAC)  
(3 x 240/415 VAC)

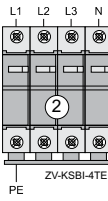

**TT-System**  
3 x 230 VAC  
(3 x 220 VAC)



**TN-S-/TT-System**  
3 x 230/400 VAC  
(3 x 220/380 VAC)  
(3 x 240/415 VAC)

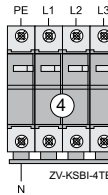

**TN-S-System**  
1 x 230 VAC  
(1 x 220 VAC)  
(1 x 240 VAC)

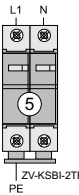

**TN-S-/TT-System**  
1 x 230 VAC  
(1 x 220 VAC)  
(1 x 240 VAC)

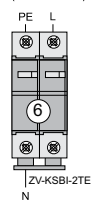

**TN-S-/TT-System**  
1 x 230 VAC  
(1 x 220 VAC) (1 x 240 VAC)

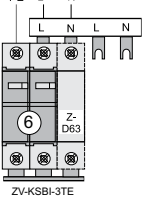

**TN-S-/TT-System**  
230 VAC

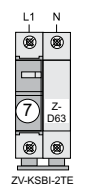

**TN-S-/TT-System**  
3 x 230/400 VAC

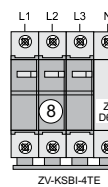

		①	②	③	④	
	IEC 60364-5-53 Clause 534	SPET2-280/3	SPET2-280/4	—	SPET2-335/3+NPE	
(A)	ÖVE ÖNORM E8101	SPET2-335/3	SPET2-335/4	—	SPET2-335/3+NPE	
(D)	VDE V 0100-534	SPET2-280/3	SPET2-280/4	—	SPET2-335/3+NPE	
(N)		SPET2-280/3	SPET2-280/4	SPET2-280/3	—	

		⑤	⑥	⑦	⑧	
	IEC 60364-5-53 Clause 534	SPET2-280/2	SPET2-335/1+NPE	—	—	
(A)	ÖVE ÖNORM E8101	SPET2-335/2	SPET2-335/1+NPE	—	—	
(D)	VDE V 0100-534	SPET2-280/2	SPET2-335/1+NPE	—	—	
(F)	UTE C 20-443	—	—	SPET2-280/1	SPET2-280/3	

**Description Auxiliary switch for Surge arrester ASAXSC-SPM**

- Field of application:  
For mounting onto surge protective devices for external defect message transmission
- Design basically in accordance with IEC 60947-5-1
- Can be mounted subsequently
- Suitable with SPBT12, SPCT2, SPET2, SPDT3, SP-B+C

**Technical Data**

	<b>ASAXSC-SPM</b>
<b>Electrical</b>	
Rated insulation voltage	250 V
Rated frequency	50 Hz
Switching contact	1 CO
Minimum voltage per contact	24 VAC
Rated operational current AC12	2 A / 250 VAC
Maximum back-up fuse	2 A gL
Overtoltage category	IV
Pollution degree	2
<b>Mechanical</b>	
Frame size	45 mm
Device height	80 mm
Device width	8.8 mm
Mounting	Screw-mounting
Degree of protection, built-in	IP40
Terminal protection	finger and hand touch safe according to DGUV VS3, EN 50274
Upper and lower terminals	lift terminals
Terminal capacity	2 x 2.5 mm <sup>2</sup>
Tightening torque of terminal screws	0.8 - 1 Nm

**Connection diagram**



**Dimensions (mm)**

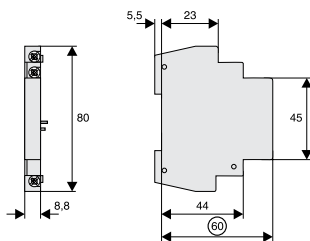

**Application Examples**

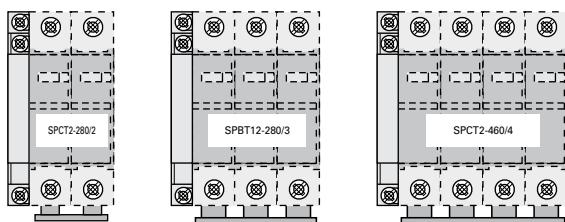

### Description Lead-Through Terminal for Surge Protective Devices, SPD-type 2 (Surge Protective Class C), ASLTT-63

- The lead-through terminal permits orderly wiring of SPDs types 2 (Surge Protective Class C).  
It serves as lead-through terminal in circuits requiring vertical connections from the upper to the lower SPD connection level.
- 1pole
- Suitable for standard busbar connection to EATON switchgear

### Technical Data

	ASLTT-63
<b>Electrical</b>	
Rated voltage	690 V AC/DC
Rated current	63 A
Rated frequency	50 Hz
<b>Mechanical</b>	
Frame size	45 mm
Device height	80 mm
Device width	17.5 mm
Mounting	quick fastening on DIN rail IEC/EN 60715
Degree of protection, built-in	IP40
Terminal protection	finger and hand touch safe according to DGUV VS3, EN 50274
Upper and lower terminals	Lift- and Maulklemme
Terminal capacity	1 - 25 mm <sup>2</sup>
Busbar thickness	0.8 - 2 mm
Tightening torque of terminal screws	2.4 - 3 Nm

### Connection diagram



### Dimensions (mm)

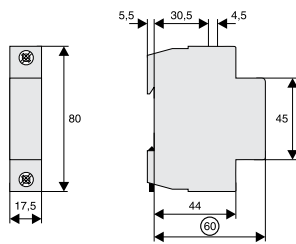

### Application Example / Connection type 2 according to IEC 60364-5-53 Clause 534

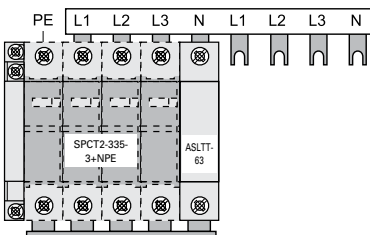

sg03213



## Beschreibung

- Test class 3 tested SPD
- Suitable to protect sensitive devices in your installation
- To be placed on a DIN-rail in the near vicinity of sensitive devices
- Auxiliary contact available as accessory

## Types

### SPD „NPE“

- Galvanic separated SPD path between neutral and protective earth
- Suitable to be placed behind an RCD due to the 1+1 connection

Test class 3 tested SPD, SPDT3

Poles	Max. Continuous Operating Voltage $U_c$	Type Designation	Article No.	Units per package
-------	--	---------------------	-------------	----------------------

### Surge arrester SPDT3

#### Single phase supply / 1+1 connection

1pole+N	335 VAC	SPDT3-335-1+NPE	170487	1/60
---------	---------	-----------------	--------	------

#### Single phase supply / 2+0 connection

2pole	280 VAC	SPDT3-280/2	170485	1/60
-------	---------	-------------	--------	------

SG03213



SPDT3-335-1+NPE

Max. Continuous Operating Voltage $U_c$	Type Designation	Article No.	Units per package
--	---------------------	-------------	----------------------

### Surge arrester SPDT3, Insert

#### Insert (1pole/path)

280 VAC	SPDT3-280	170484	2/120
335 VAC	SPDT3-335	170486	2/120

sg03413



**Description Surge Protective Class T3**

- Field of application:  
For fine protection of user equipment against transient overvoltage
- For mounting on DIN rails in distribution boxes for electrical installation
- No decoupling from upstream surge protection in the low voltage distribution system required
- Test class III according to IEC 61643-11
- SPD-type T3 according to EN 61643-11
- Suitable for high back-up fuse 63 A gL / C 63
- Auxiliary switch ASAXSC-SPM for remote message transmission can be mounted onto the device

**Technical Data**

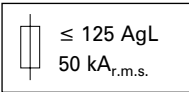
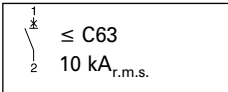
		<b>SPDT3-335-1+NPE</b>	<b>SPDT3-280/2</b>
<b>Electrical</b>			
Mechanical coding		yx	xx
Responding time (rate of voltage rise 5 kV/μs)		L-N/N-PE/L-PE < 25ns/< 100ns/< 100ns	L1-L2(N)/L2(N)-PE/L1-PE < 25ns
Max. continuous operating voltage	$U_C$	L-N/N-PE 335VAC/260VAC	L1-L2(N)/L2(N)-PE 280VAC
TOV test value	$U_T$		
5 s		L-N/L-PE 348VAC/416VAC	L-N/L-PE 348VAC/416VAC
200 ms		N-PE 1200VAC	N-PE 1200VAC
Rated frequency		50 Hz	50 Hz
Open circuit voltage	$U_{OC}$	L-N/N-PE/L-PE 6kV	L1-L2(N)/L2(N)-PE/L1-PE 6kV
Voltage protection level at UOC	$U_p$	L-N/N-PE/L-PE $\leq 1000V/\leq 1500V/\leq 1000V$	L1-L2(N)/L2(N)-PE $\leq 900V$
Nominal discharge current (8/20) μs	$I_n$	L-N/N-PE/L-PE 2.5kA	L1-L2(N)/L2(N)-PE 5kA
Voltage protection level at $I_n$	$U_p$	L-N/N-PE/L-PE $\leq 1000V/\leq 1500V/\leq 1000V$	L1-L2(N)/L2(N)-PE $\leq 950V$
Max. discharge current (8/20) μs	$I_{max}$	L-N/N-PE/L-PE 10kA	L1-L2(N)/L2(N)-PE/L1-PE 10kA
Follow current interrupt rating	$I_{fi}$	N-PE 100 $A_{r.m.s.}$	-
Maximum back-up fuse			
Maximum short-circuit current			

Connection diagram



**Mechanical**

Mechanical coding of base	yx	xx
Frame size	45 mm	45 mm
Device height	80 mm	80 mm
Device width	35 mm	35 mm
Weight	220 g	220 g
Permitted ambient temperature	-40°C to +70°C	-40°C to +70°C
Degree of protection	IP20	IP20
Upper and lower lift terminal capacity	1 - 25 mm <sup>2</sup>	1 - 25 mm <sup>2</sup>
Upper and lower open mouthed terminals for busbar thickness up to	1.5 mm	1.5 mm
Tightening torque of terminal screws	2.4 - 3 Nm	2.4 - 3 Nm
Quick fastening on DIN rail according to	IEC/EN 60715	IEC/EN 60715

**Dimensions (mm)**

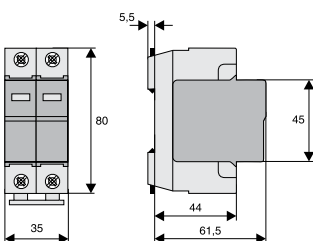

**Application Examples**

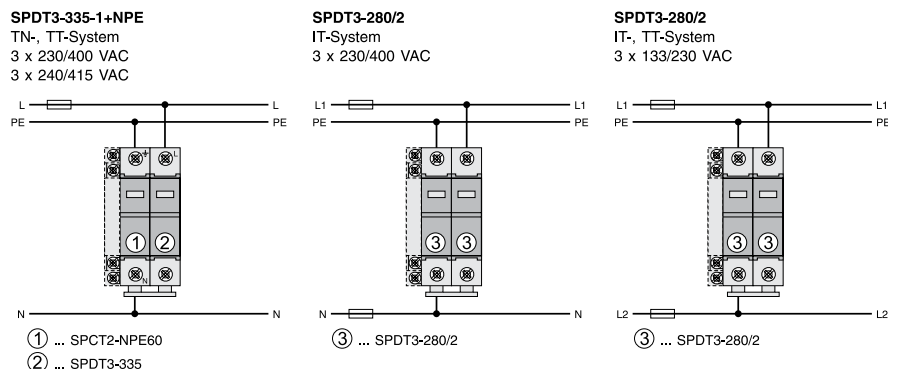

# 1.44

## Surge Protection

xPole







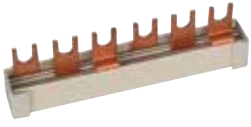







### Busbar

Used for	Type Designation	Article No.	Units per package
<b>Busbar Z-GV-16/3P-3TE/6</b>			
for SPBT12 & SPCT2	Z-GV-16/3P-3TE/6	267511	12/240

WA\_SG11202





Poles	Type Designation	Article No.	Units per package
<b>Busbar ZV-KSBI for SPBT12 &amp; SPCT2</b>			
 ZV-KSBI-2TE	2MU	ZV-KSBI-2MU	263961 10/600
 ZV-KSBI-3TE	3MU	ZV-KSBI-3TE	263962 10/600
 ZV-KSBI-3TE/S	3MU	ZV-KSBI-3TE/S	263963 10/600
 ZV-KSBI-3TE+HI	2MU+1.5MU	ZV-KSBI-3TE+HI	112370 50/150
 ZV-KSBI-4TE	4MU	ZV-KSBI-4TE	263964 10/600
 ZV-KSBI-5TE	5MU	ZV-KSBI-5TE	263965 10/200
 ZV-KSBI-5TE/N	5MU	ZV-KSBI-5TE/N	263966 10/200
 ZV-KSBI-5TE+HI	2MU+3x1.5MU	ZV-KSBI-5TE+HI	112371 50/150
 ZV-KSBI-6TE	6MU	ZV-KSBI-6TE	113118 50/500
 ZV-KSBI-7TE	7MU	ZV-KSBI-7TE	263967 50/500
 ZV-KSBI-7TE/S	7MU	ZV-KSBI-7TE/S	263968 10/100
 ZV-KSBI-7TE/N	7MU	ZV-KSBI-7TE/N	263969 10/100
 ZV-KSBI-9TE/N	9MU	ZV-KSBI-9TE/N	266874 50/500
 ZV-KSBI-11TE	11MU	ZV-KSBI-11MU	263970 50/500

**Description busbar ZV-KSBI**

- With the ZV KSBI busbar bracket you can realize the common combinations of arrestors.
- Used for SPB-..., SPC-..., Z-D63
- The rated cross-section of the ZV-KSBI bridge metals is 16 mm<sup>2</sup>
- The busbar mounting bracket can be shortened

**Technical Data**

ZV-KSBI	
<b>Electrical</b>	
Rated voltage	230/400 V, 50/60 Hz
Rated current	63 A
<b>Mechanical</b>	
Busbar cross section	16 mm <sup>2</sup> Cu

**Design**

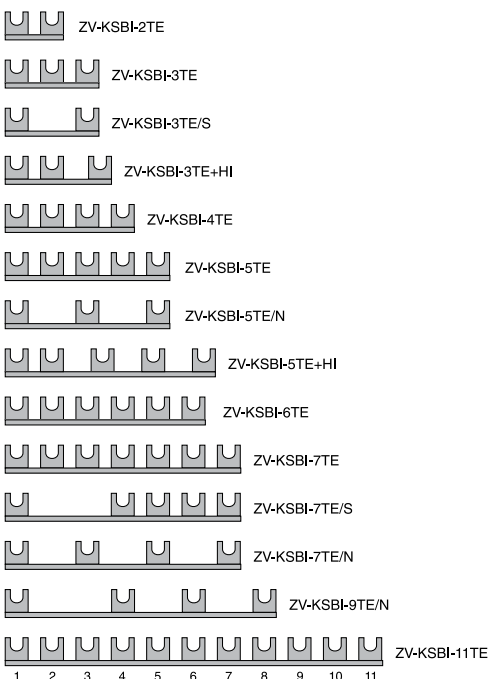

wa\_sg106319



### Description

- Suitable SPD for PV applications
- Test class 2 tested SPDs are suitable for applications without an external lightning protection system
- Auxiliary contact available with AX types

### Types

#### SPPV „AX“

- These types come with an auxiliary contact

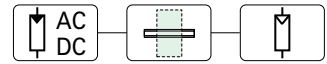

DC voltage per MPPT  
 $U_c$

Type  
Designation

Article No.

Units per  
package

**Plug-in Surge Arrester SPPVT2 for Photovoltaic application**

- For insulated and earthed systems

sg04914



600 V DC	SPPVT2-06-2+PE	176088	1/40
1000 V DC	SPPVT2-10-2+PE	176090	1/40

**With auxiliary switch**

600 V DC	SPPVT2-06-2+PE-AX	176087	1/40
1000 V DC	SPPVT2-10-2+PE-AX	176089	1/40

sg04714



**Inserts for replacement**

600 V DC	SPPVT2-06	176091	1/50
1000 V DC	SPPVT2-10	176092	1/50

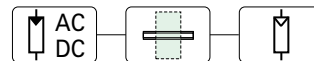

### Description Plug-in Surge Arrester SPPVT2-...-2+PE(-AX)

- Increased safety through compliance with the IEC 61643-31 standard
- Safe contacting thanks to integrated redary bolts
- Easy to replace thanks to a plug-type arrester
- Optimal protection of the inverter thanks to a low protection level
- Selective replacement of defective connectors thanks to a visual status indicator
- Optimized planning of maintenance interventions thanks to remote signalling (Type -AX)
- No wrong connecting possible thanks to coded connectors and base elements

### Connection diagram

SPPVT2(H)-...-2+PE(-AX)

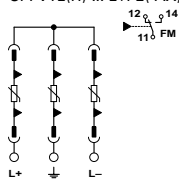

### Dimensions (mm)

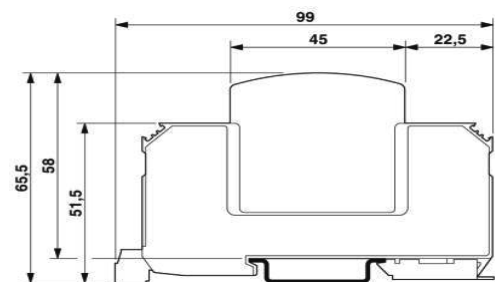

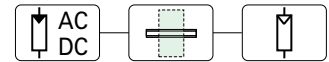

**Technical Data**

	<b>SPPVT2-06-2+PE(-AX)</b>	<b>SPPVT2-10-2+PE(-AX)</b>
<b>Environmental condition</b>		
Degree of protection	IP20	IP20
Ambient temperature of operation	-40 ... +80°C	-40 ... +80°C
Altitude	≤ 2000 m	≤ 2000 m
Allowed range of air humidity of operation	5 ... 95 %	5 ... 95 %
<b>General</b>		
Standards/regulations	IEC/EN 61643-31	IEC/EN 61643-31
IEN Test class	PV T2	PV T2
SPD failure performance	OCFM	OCFM
Mounting	DIN rail 35 mm	DIN rail 35 mm
Material of the enclosure	PBT/PA	PBT/PA
Pollution degree	II	II
Flammability class according to UL 94	V0	V0
Signal for surge protection defective	visual, with remote signalling contact	visual, with remote signalling contact
<b>Predictive circuit on the direct current side (DC)</b>		
Max. continuous operating voltage	$U_{CPV}$ 800 V DC	1170 V DC
No-load output voltage	$U_{DCSTC}$ ≤ 670 V DC	≤ 975 V DC
Short-circuit current strength	$I_{SCPV}$ 2000 A	2000 A
Nominal load current	$I_L$ 80 A DC	80 A DC
Predictive conductor current	$I_{PE}$	
DC	≤ 20 µA	≤ 20 µA
AC	≤ 300 µA	≤ 250 µA
Standby power consumption	$P_c$ ≤ 20 mVA	≤ 25 mVA
Nominal discharge current (8/20) µs	15 kA	15 kA
Maximum discharge current (8/20) µs	$I_{max}$ 40 kA	40 kA
Total lightning discharge current (8/20) µs	$I_{Total}$ 40 kA	40 kA
Voltage protection level (L+) - (L-)	$U_p$ ≤ 2.7 kV	≤ 3.7 kV
Voltage protection level (L+/L-) - PE	$U_p$ ≤ 2.7 kV	≤ 3.7 kV
Responding time	$t_A$ ≤ 25 ns	≤ 25 ns
<b>Size</b>		
Hight	99 mm	99 mm
Width	53.4 mm	53.4 mm
Depth	63.6 mm	63.6 mm
Module units (MU)	3 MU	3 MU
<b>Weight</b>		
...+PE	gross 313 g / net 288 g	gross 337 g / net 311 g
...+PE-AX	gross 320 g / net 294 g	gross 343 g / net 317 g
<b>Connection data</b>		
<b>Type of connection</b>	<b>Screw connection</b>	<b>Screw connection</b>
Lift terminal capacity		
flexible	1.5-25 mm <sup>2</sup>	1.5-25 mm <sup>2</sup>
solid	1.5-35 mm <sup>2</sup>	1.5-35 mm <sup>2</sup>
Bolt thread	M5	M5
Tightening torque	4.5 Nm	4.5 Nm
Stripping length	16 mm	16 mm
<b>Auxiliary Switch</b>		
Switching function	CO, 1-pole	CO, 1-pole
Rated operational voltage	5 ... 250 V AC, 30 V DC	5 ... 250 V AC, 30 V DC
Rated operational current	5 mA ... 1.5 A AC, 1 A DC	5 mA ... 1.5 A AC, 1 A DC
Type of connection	MC 1.5/3	MC 1.5/3
Lift terminal capacity		
flexible	0.14-1.5 mm <sup>2</sup>	0.14-1.5 mm <sup>2</sup>
solid	0.14-1.5 mm <sup>2</sup>	0.14-1.5 mm <sup>2</sup>
Lift terminal capacity AWG/kcmil	30 ... 14	30 ... 14
Bolt thread	M2	M2
Tightening torque	0.25 Nm, 2 ... 4 lb in	0.25 Nm, 2 ... 4 lb in
Stripping length	7 mm	7 mm

wa\_sg125819



## Description

- Suitable SPD for PV applications
- Combined test class 1/2 tested SPDs are suitable for applications with an external lightning protection system
- Auxiliary contact available with AX types

## Types

### SPPV „AX“

- These types come with an auxiliary contact

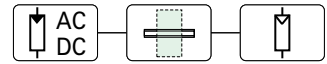

DC voltage per MPPT  
 $U_c$

Type  
Designation

Article No.

Units per  
package

**Plug-in Surge Arrester SPPVT12 for Photovoltaic application**

- For insulated and earthed systems

sg04914



600 V DC	SPPVT12-06-2+PE	177258	1/40
1000 V DC	SPPVT12-10-2+PE	177256	1/40

**With auxiliary switch**

600 V DC	SPPVT12-06-2+PE-AX	177257	1/40
1000 V DC	SPPVT12-10-2+PE-AX	177255	1/40

sg04714



**Inserts for replacement**

600 V DC	SPPVT12-06	177259	1/50
1000 V DC	SPPVT12-10	177260	1/50

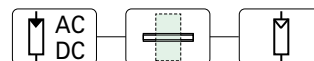

### Description Plug-in Surge Arrester SPPVT12-...-2+PE(-AX)

- Increased safety through compliance with the IEC 61643-31 standard
- Safe contacting thanks to integrated redary bolts
- Easy to replace thanks to a plug-type arrester
- Optimal protection of the inverter thanks to a low protection level
- Selective replacement of defective connectors thanks to a visual status indicator
- Optimized planning of maintenance interventions thanks to remote signalling (Type -AX)
- No wrong connecting possible thanks to coded connectors and base elements
- Always the right arrester thanks to universal Type1/Type2 preductive components

### Connection diagram

SPPVT12-...-2+PE(-AX)

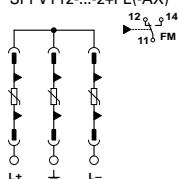

### Dimensions (mm)

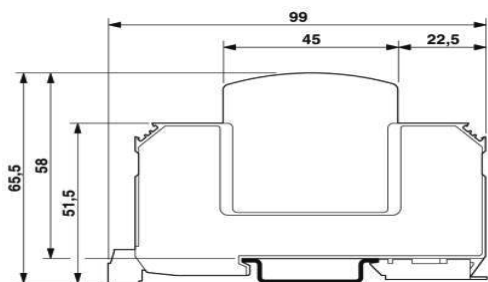



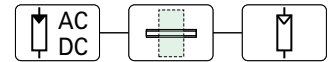

**Technical Data**

	<b>SPPVT12-06-2+PE(-AX)</b>	<b>SPPVT12-10-2+PE(-AX)</b>
<b>Environmental condition</b>		
Degree of protection	IP20	IP20
Ambient temperature of operation	-40 ... +80°C	-40 ... +80°C
Altitude	≤ 2000 m	≤ 2000 m
Allowed range of air humidity of operation	5 ... 95 %	5 ... 95 %
<b>General</b>		
Standards/regulations	IEC/EN 61643-31	IEC 61643-31
IEN Test class	PV T1/PV T2	PV T1/PV T2
SPD failure performance	OCFM	OCFM
Mounting	DIN rail 35 mm	DIN rail 35 mm
Material of the enclosure	PBT/PA	PBT/PA
Pollution degree	II	II
Flammability class according to UL 94	V0	V0
Signal for surge protection defective	visual, with remote signalling contact	visual, with remote signalling contact
<b>Predictive circuit on the direct current side (DC)</b>		
Max. continuous operating voltage	$U_{CPV}$ 720 V DC	1170 V DC
No-load output voltage	$U_{OCSTC}$ ≤ 600 V DC	≤ 975 V DC
Short-circuit current strength	$I_{SCPV}$ 2000 A	2000 A
Nominal load current	$I_L$ 80 A DC	80 A DC
Predictive conductor current	$I_{PE}$	
DC	≤ 20 μA	≤ 20 μA
AC	≤ 350 μA	≤ 350 μA
Standby power consumption	$P_C$ ≤ 25 mVA	≤ 25 mVA
Nominal discharge current (8/20) μs	15 kA	15 kA
Maximum discharge current (8/20) μs	$I_{max}$ 40 kA	40 kA
Lightning test current (10/350) μs, Peak current	$I_{imp}$ 5 kA	5 kA
Total lightning discharge current (8/20) μs	$I_{Total}$ 7 kA	5 kA
Voltage protection level (L+) - (L-)	$U_p$ ≤ 2.6 kV	≤ 3.5 kV
Voltage protection level (L+/L-) - PE	$U_p$ ≤ 2.6 kV	≤ 3.5 kV
Responding time	$t_A$ ≤ 25 ns	≤ 25 ns
Required max. back-up fuse with stub-line wiring	not necessary	not necessary
<b>Size</b>		
Height	99 mm	99 mm
Width	53.4 mm	53.4 mm
Depth	63.6 mm	63.6 mm
Module units (MU)	3 MU	3 MU
<b>Weight</b>		
...+PE	gross 407 g / net 379 g	gross 407 g / net 379 g
...+PE-AX	gross 414 g / net 386 g	gross 414 g / net 386 g
<b>Connection data</b>		
<b>Type of connection</b>	<b>Screw connection</b>	<b>Screw connection</b>
Lift terminal capacity		
flexible	1.5-25 mm <sup>2</sup>	1.5-25 mm <sup>2</sup>
solid	1.5-35 mm <sup>2</sup>	1.5-35 mm <sup>2</sup>
Bolt thread	M5	M5
Tightening torque	4.5 Nm	4.5 Nm
Stripping length	16 mm	16 mm
<b>Auxiliary Switch</b>		
Switching function	CO, 1-pole	CO, 1-pole
Rated operational voltage	5 ... 250 V AC, 30 V DC	5 ... 250 V AC, 30 V DC
Rated operational current	5 mA ... 1.5 A AC, 1 A DC	5 mA ... 1.5 A AC, 1 A DC
Type of connection	MC 1.5/3	MC 1.5/3
Lift terminal capacity		
flexible	0.14-1.5 mm <sup>2</sup>	0.14-1.5 mm <sup>2</sup>
solid	0.14-1.5 mm <sup>2</sup>	0.14-1.5 mm <sup>2</sup>
Lift terminal capacity AWG/kcmil	30 ... 14	30 ... 14
Bolt thread	M2	M2
Tightening torque	0.25 Nm, 2 ... 4 lb in	0.25 Nm, 2 ... 4 lb in
Stripping length	7 mm	7 mm

Eaton's electrical business is a global leader with deep regional application expertise in power distribution and circuit protection; power quality, backup power and energy storage; control and automation; life safety and security; structural solutions; and harsh and hazardous environment solutions. Through end-to-end services, channel and an integrated digital platform & insights Eaton is powering what matters across industries and around the world, helping customers solve their most critical electrical power management challenges.

For more information, visit [Eaton.com](https://www.eaton.com).



<http://id1.hu/eaton/villamos-halozatok-vedelme/tulfeszultseg-vedelem>

**Eaton Industries (Austria) GmbH**  
Scheydgasse 42  
1210 Vienna  
Austria

**Eaton**  
EMEA Headquarters  
Route de la Longeraie 7  
1110 Morges, Switzerland

© 2022 Eaton  
All Rights Reserved  
Publication No. CA010001EN  
Article number 301969-MK  
May 2022

Changes to the products, to the information contained in this document, and to prices are reserved; as are errors and omissions. Only order confirmations and technical documentation by Eaton is binding. Photos and pictures also do not warrant a specific layout or functionality. Their use in whatever form is subject to prior approval by Eaton. The same applies to trademarks (especially Eaton, Moeller, and Cutler-Hammer). The Terms and Conditions of Eaton apply, as referenced on Eaton Internet pages and Eaton order confirmations.

Eaton is a registered trademark.

All other trademarks are property of their respective owners.

Follow us on social media to get the latest product and support information.

