

xEffect - Industrial Switchgear Range



Catalog



Powering Business Worldwide



We make what matters work.*

* At Eaton, we believe that power is a fundamental part of just about everything people do. That's why we're dedicated to helping our customers find new ways to manage electrical, hydraulic and mechanical power more efficiently, safely and sustainably. To improve people's lives, the communities where we live and work, and the planet our future generations depend upon. Because this is what really matters. And we're here to make sure it works.

To learn more go to: [Eaton.com/whatmatters](https://www.eaton.com/whatmatters)

EATON

Powering Business Worldwide

We make what matters work.

MCBs and RCCBs for North American market UL certified for eOEMs who acting worldwide providing power distribution systems for Power Plants in North America.

High frequency TL lighting is often used in agricultural industry applications (such as barns). Conventional circuit breakers appear to sometimes fail spontaneously, which is very undesirable in barns. Consider a failure of the ventilation systems, feeding systems, manure and egg collection in poultry barns. By using the new digital circuit breaker from Eaton, the problem of undesired switch off can be minimized.



B+ type RCCB for enhanced fire protection and where DC leakage currents occur – data centers,

High safety relevant applications e.g. hospitals where digital RCCBs are used in the distribution system,



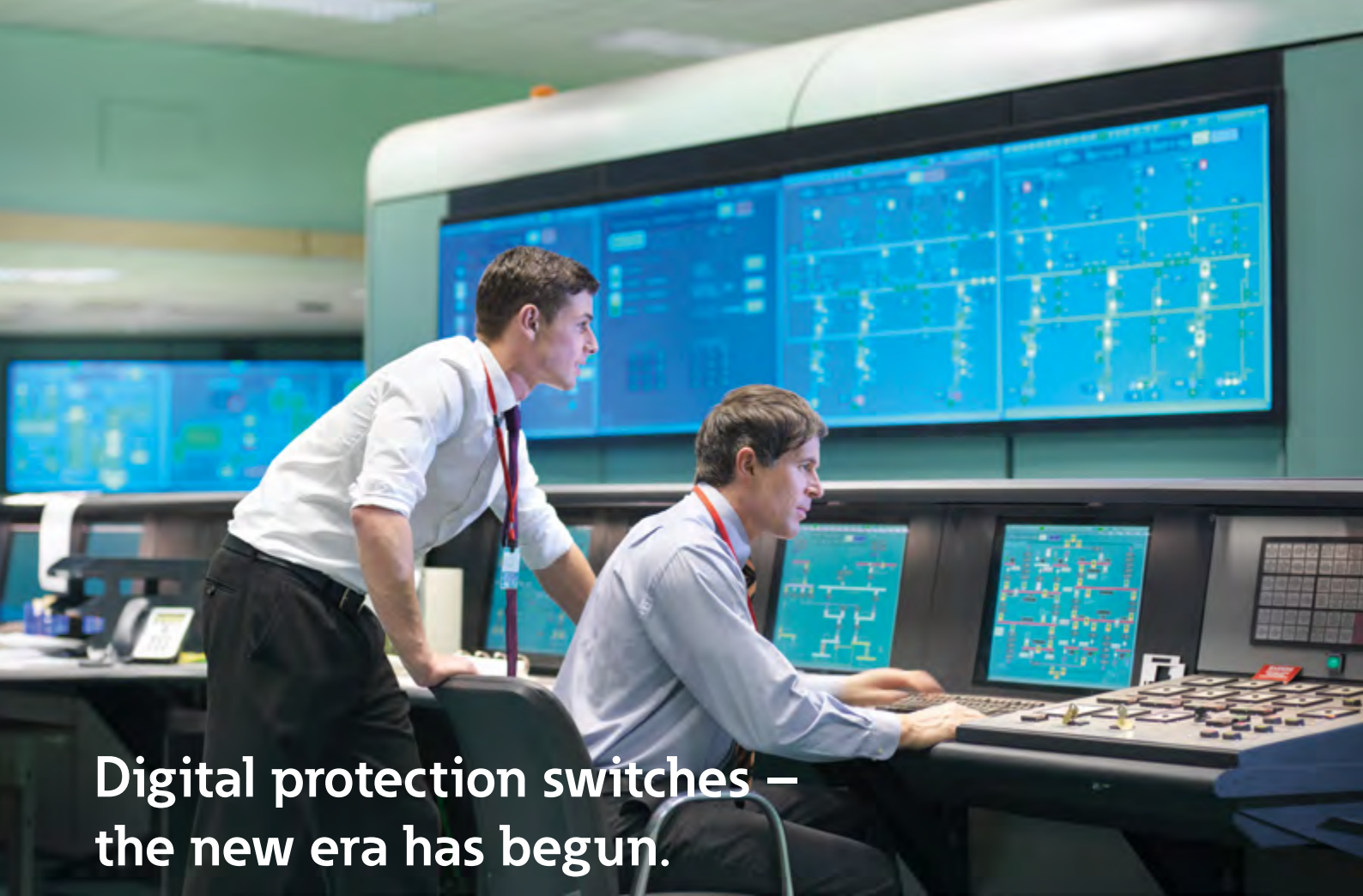

Digital protection switches – the new era has begun.

Better security with proactive communication!

The digital RCCB from Eaton’s xEffect series are capable to do more than just switch off: They monitor electrical installations and issue advance warnings of critical current flows. Thanks to short time delay and optimized tripping threshold, briefly occurring malfunctions do not induce the digital protection switch to shut down.

When a fault current crops up, the information is reported to the security center of the industrial plant right away and troubleshooting can start before a plant failure occurs. Thus the cause of the fault current can be determined precisely and the system can be serviced easily.

That way, system availability increases and service is crucially improved by the convenient remote control.

Numerous advantages at a glance

- The difference between harmless and critical fault currents is detected
- Precise switching and reduction of nuisance tripping
- Continuous monitoring of plant/factory status – prompt warning of a change in status quo
- Convenient troubleshooting by precise location of the malfunction
- As easy to install as a conventional RCCB
- Longer intervals between servicing
- Ideal for system monitoring thanks to preventive information
- Warning of tripping at leakage current
- Clear status display of the fault current problem with tri-colored LEDs
- Real contact position indicator
- Indicator for fault current tripping
- Comprehensive range of accessories available
- Can be integrated in several bus systems

Highly qualified controllers offer their services

PROMOTION

Allow us to introduce ourselves: **FRCdM** and **FRBdM** would like to work in your switchbox. We're two highly qualified control robots from the famous EATON talent factory – the first of the new digital generation.

It's not only that I work completely reliably as a Residual Current Operated Circuit Breaker with integrated Overcurrent Protection (RCBO), but I also display the cause and extent of the flowing fault current. This enables to take fast actions in order to maintain system availability.

And since I'm the RCCB a fault current protection switch, I don't wait until the tripping threshold is reached; I check the present status and register any possible failures, and send this information by remote warning immediately to the central control system. This increases system safety, application availability and minimizes maintenance costs.

Hire us – and experience finally communication at eye level!

The LEDs set off an alarm when fault currents or a shutdown are coming. This makes the troubleshooting faster and much easier. The service mode of the RCBO quickly indicates the extent of the flowing fault current in milliamp increments. By pushing the service button, the blinking LED identifies the area where the fault current is located in. The potential-free contact which is integrated in the RCCB offers a connection to a monitoring system.

- Residual current protection and additional protection with other digital functions
- Auto-reclosure is possible



Red

When the red LED lights up, the leakage current is already higher than 50 percent of the nominal fault current. Therefore the system is in a critical status – the digital RCCB only trips when the fault current continues to increase.



Yellow

The yellow LED shows a residual current in the ambit of 30 to 50 percent of the nominal fault current. Before the system is shut down, professional countermeasures can be taken.



Green

If the current flow in the system to ground is in the ambit from 0 to 30 percent of the nominal fault current, the green LED indicates the proper status.



FRBdM and FRCdM offer several other advantages



The LED enables a fault current display directly on site. In the service mode, malfunction causes can be determined quickly and without complication.

Digital RCBO Type A

Protects against special forms of residual pulsating DC which have not been smoothed.

Digital RCBO Type F

Sensitive to pulsating DC residual current and detection of multifrequency residual currents up to 1 kHz

- Increased protection due to the detection of mixed frequencies
- Higher load rating with DC residual currents up to 10 mA
- Reduction of nuisance tripping thanks to time delayed tripping and increased current withstand capability of 3 kA



The digital display facilitates real-time diagnostics directly at the switch. By means of the LEDs, the system status can be checked anytime, and with one glance.

All models have at least a short time delay to prevent from nuisance tripping due to transient disruptions (lightning, engine start).

Digital RCCB Type A

Protection in case of sinusoidal AC fault currents and pulsating currents with DC components up to 6 mA.

Digital RCCB Type F

These types are capable of sensing pulsating residual currents, residual currents up to 1 kHz and are not negatively affected by a DC overlay of up to 10 mA. They replace the obsolete Type U due to improvements in standardization as well as technical design.

Digital RCCB Type B

In addition to fault currents in the AC and pulse current range, type B also detects smooth DC fault currents which can occur in frequency inverter controls, photovoltaic systems and increases safety considerably.

Digital RCCB Type B+

Complies with the standard VDE 0664-400 (formerly VVDEV 0664-110) for superior fire protection as required by the Association of German Insurance Companies. The type B+ detects high frequency currents up to 20 kHz and the tripping level is limited to max. 420 mA over the defined frequency range.

Digital RCCB Type Bfq

The type Bfq complies with the requirements of the type B. The tripping curve is extended and allows the defection of high frequency currents up to 50 kHz. The adjusted frequency behaviour (insensitive to higher frequencies) prevents nuisance tripping errors in industrial plants with powerful frequency inverter controllers.

Residual Current Devices Type F



Benefits:

- Reliable protection for machines with 1phase frequency converters and 3phase frequency converters if no type B is needed
- Increased protection due to
 - detection of mixed frequencies
 - higher load rating with DC residual currents up to 10 mA
- Reduction of nuisance tripping thanks to
 - time delayed tripping
 - high current withstand capability

Definition

The type F RCD is defined according to IEC/EN 62423. It provides safe and reliable protection against sinusoidal residual currents and pulsating DC fault currents (like type A devices). It is also capable of handling residual currents with mixed frequencies of up to 1 kHz (10, 50, 1000 Hz) in accordance with the IEC 62423 standard.

Type F RCDs can accept smooth DC residual currents of up to 10 mA without

affecting their standard functionality, have a time delayed tripping and distinguish themselves from other devices thanks to their high resistance to power surges: this ensures minimal false tripping and a high degree of safety.

They are available as RCCBs (2-pole or 4-pole up to 100 A) as well as RCBOs (1N up to 40 A). With three versions for different protection levels (30 mA, 100 mA and 300 mA), the type F functionality is

voltage independent and can be used for fault and additional protection. As a result, the recommendations for installations including variable frequency drives have been modified.

Eaton also offers a digital version of the type F RCBO and RCCB. These devices display fault currents in real time.

Field of Application

Type F residual current devices are designed specifically for use in applications with single phase frequency converters such as pumps, welding units, vibrators or hammer drills. They are also highly recommended for 3phase frequency converter applications where no Type B is necessary. In this type of application, residual currents with mixed frequencies can arise which residual current devices type AC and A are unable to cope with.

The detection of mixed frequencies and the higher load rating with DC residual currents up to 10 mA enables the RCD type F to provide excellent protection for humans and the system in all applications which contain appliances and motors with single phase frequency converters.

The time delayed tripping and the high current withstands capability support in addition avoiding nuisance tripping. Overall, the RCD type F enables machine builders and plant manufacturers to develop equipment that is extremely reliable while ensuring high safety levels for the operator and maintenance staff.



Selection help RCDs Type F / Type B

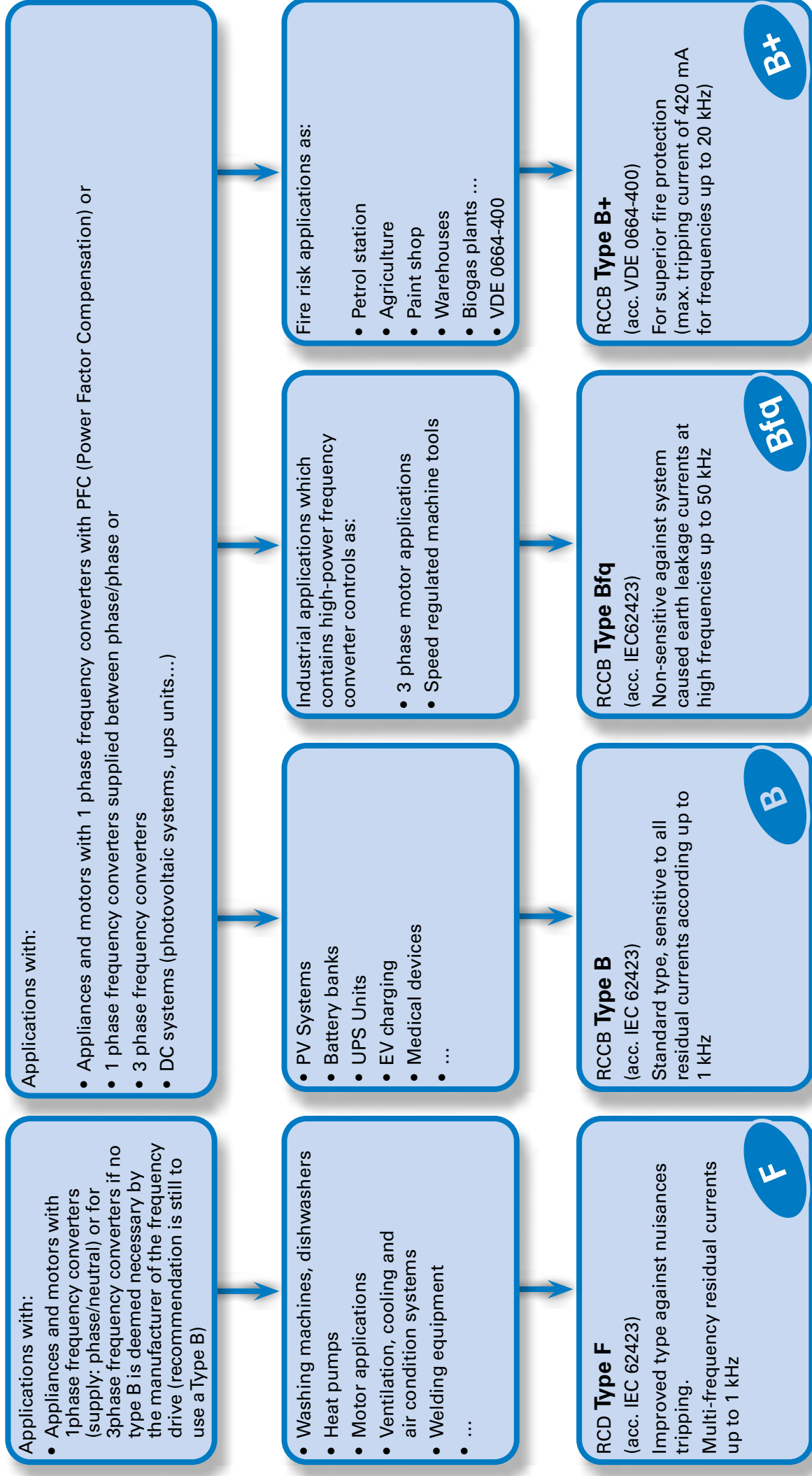

Lean connectivity for protective devices (MCBs, RCCBs, RCBOs)



- Permanent information of the system
- Decrease system downtime/Increase system uptime
- Direct connection to the SmartWire-DT line
- Reduction of installation time, wiring and costs

The SmartWire-DT MCB module allows a fast and easy connection of protective devices as MCBs, RCCBs and RCBOs to the SmartWire-DT line.

This gives machinery builders and installers the possibility to integrate protective devices comfortably in the Lean automation.

The status (on, off, tripped) of the protective devices is so implemented in the control or monitor system of the machinery or the power distribution and supports the service and maintenance teams permanently with information about the system and helps to react immediately in case of problems to keep the system downtime as short as possible.

A further big benefit is also the direct connection on the SmartWire-DT line. This makes the additional I/O level and wiring redundant and machinery builders can reduce so installation time and costs.



Example: Savings in every step of the life cycle

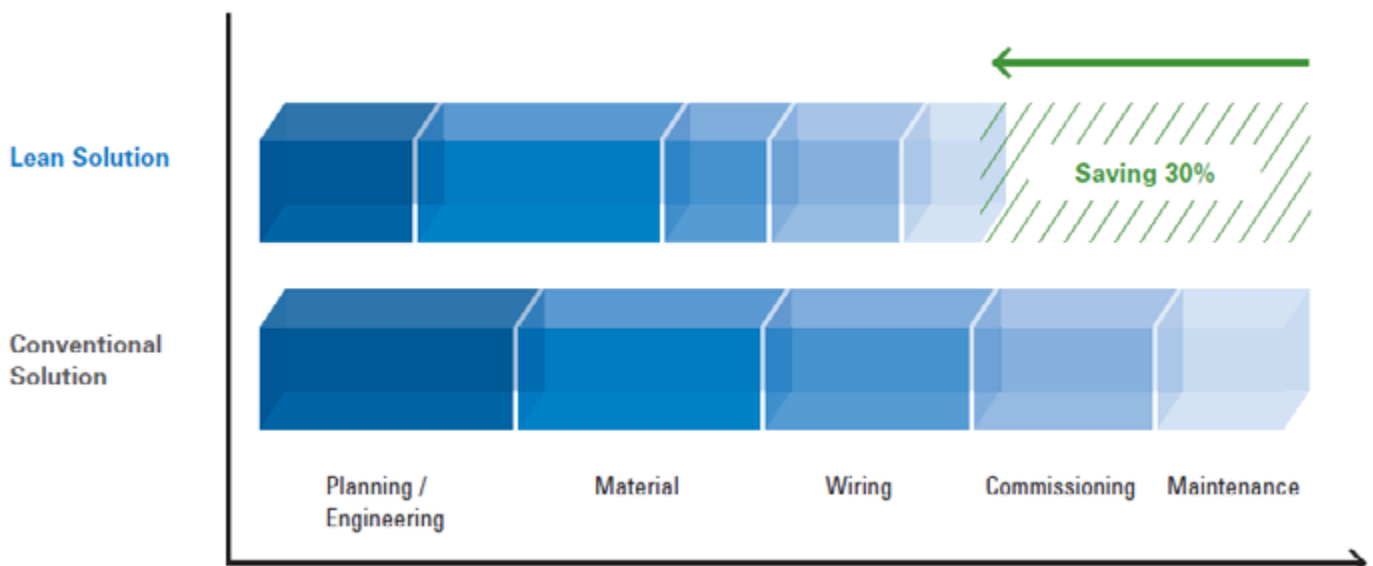

Eaton help you build better and safer trains

Compliance

Eaton is offering leading products that guarantee the highest levels of safety and performance according to specific standards such as IEC 61373 (Rolling stock equipment - Shock and vibration tests) or EN 45545-2 (Fire protection on railway vehicles).

Eaton products comply with the usual electrical standards (IEC and UL) for a worldwide usage.

With a unique mix of products, Eaton possesses industry-recognized safety products that are specifically designed for the railway's harsh and hazardous environment.

Competitiveness

Eaton is providing a large range of standard products covering the major electrical components used in rolling stock, and which are designed to reduce the level of maintenance required even when operating in harsh environmental conditions.

You can optimize your total cost of ownership by reducing the maintenance cost with our proven long life-time products.

Our innovation center and engineering teams are designing customized solutions that enhance productivity. Our engineering services help to optimize investment cost.

Expertise and Partnerships

With our rail competency center and a network of application engineers, we ensure that new and refurbished trains offer high levels of reliability and help to reduce total cost of ownership.

Legacy of innovation

With 30 years of experience in rail, our innovative portfolio has grown, including solutions from:

Heinemann	Cooper
Bussmann	Walterscheid
Moeller	Vickers
Martek Power	Aeroquip





Protect your passengers and equipment

Applications

Protection of electrical equipment such as:

- Motors
- HVAC systems
- Power outlets
- Door control
- Lighting
- Signaling
- Battery box

Your challenges

- Fire safety
- Harsh environmental conditions
- Long life cycle
- Long cables
- Temperature variation

Our solutions

Eaton has an unique offer of power protection devices, including:

- Miniature Circuit Breakers (MCB)
- Residual Current Devices (RCD)
- Electronic protection modules (PXS)

Benefits

- Rail certified MCBs & RCDs from one hand
- Electronic protection modules for safe and reliable protection of 24 VDC circuits
- Special characteristics to avoid nuisance tripping
- Digital RCDs to increase system availability
- RT MCBs & RCDs for safe & reliable electrical connections
- IEC 61373 (Shock & Vibration)
- EN 45545 (Smoke & Fire)

Safe & reliable connections

- Eaton's xEffect portfolio contains also special RT MCB & RCD ranges.
- The xEffect RT ranges are especially designed for the use with ring cable lugs.
- These ensure the highest safety and reliability for electrical connections.
- The PXS24 electronic protection modules are equipped with push-in terminals, another very reliable type of connection.

Description type designation RCD's

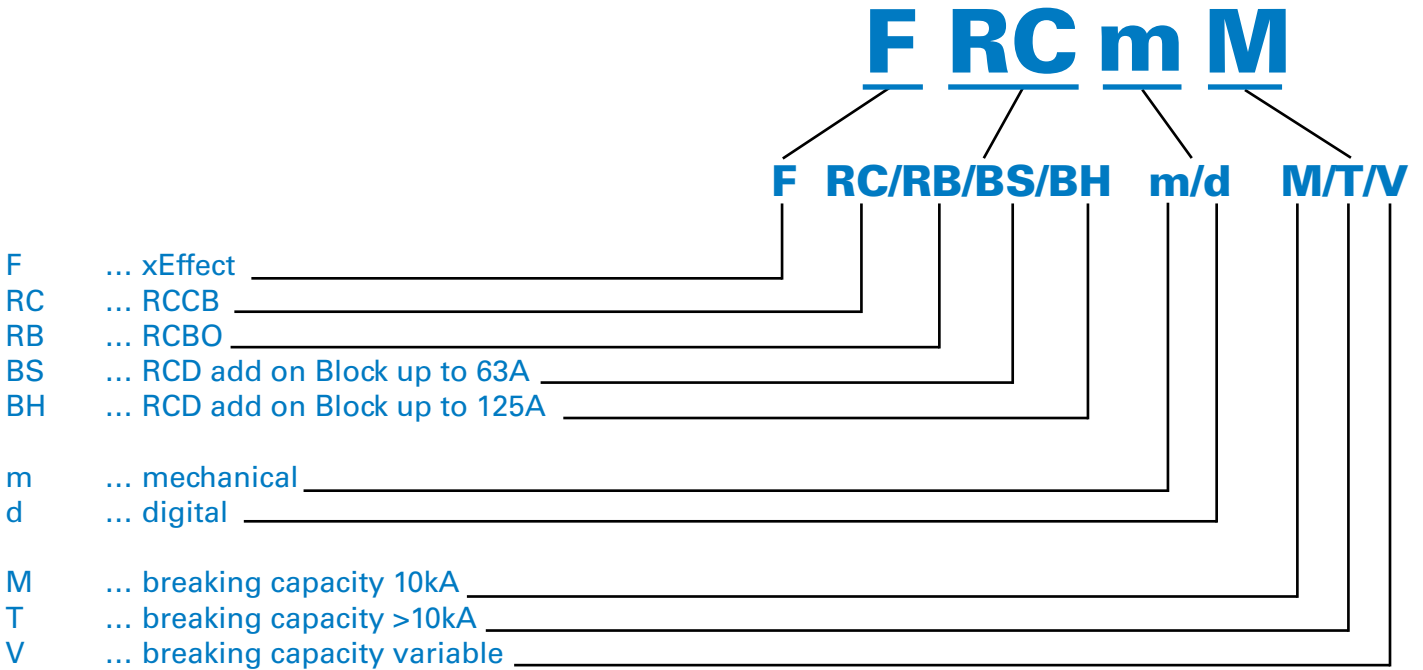

Description type designation MCB's

- FAZ ... MCBs up to 63A
- FAZT ... MCBS up to 40A with braking capacity >10kA
- AZ ... MCBs up to 125A

General definitions

- RCD ... Residual Current operated Device (umbrella term for RCCB and RCBO)
- RCCB ... Residual Current Circuit Breaker
- RCBO ... Residual Current Operated Circuit Breaker with Overcurrent Protection
- MCB ... Miniature Circuit Breaker

SG49712



Protective Devices

1. General

- Switch Gear Digital Page 1.3

2. Components

- RCCB
 - RCCB FRCdM Type A and F, Digital Page 1.7
 - RCCB FRCdM Type B, Bfq and B+, Digital Page 1.15
 - RCCB FRCmM Type AC, A and F Page 1.26
 - RCCB FRCmM - RT Type A and S Page 1.34
 - RCCB FRCmM-110 Type AC, A Page 1.41
 - RCCB FRCmM-NA Type A Page 1.47
 - RCCB FRCmM-NA-110 Type A Page 1.54
 - RCCB FRCmM-125 Type A, B, Bfq and B+ Page 1.60
 - RCCB FRCmM Type B (non-digital) Page 1.70
- Combined RCD/MCB Devices
 - Combined RCD/MCB Devices FRBdM 1+N, 2-poles Type A Digital Page 1.75
 - Combined RCD/MCB Devices FRBmM 1+N Type AC, A and F Page 1.90
 - Combined RCD/MCB Devices FRBmM - RT 1+N, Type A Page 1.99
 - Combined RCD/MCB Devices FRBmM, FRBm6, 2-poles Type AC and A Page 1.108
 - Combined RCD/MCB Devices FRBmM, 3-poles Type A Page 1.133
 - Combined RCD/MCB Devices FRBmM - RT 3-poles Type A Page 1.135
 - Combined RCD/MCB Devices FRBm6, FRBm4, 3+N-poles Type AC and A Page 1.145
- Add-on Residual Current Protection
 - Add-on Residual Current Protection Unit FBSmV Type AC and A Page 1.154
 - Add-on Residual Current Protection Unit FBHmV Type AC and A Page 1.161
- PXS24 - Electronic Protective Devices
 - PXS24 - Electronic Protective Devices for 24 V DC circuits Page 2.168
- MCB
 - MCB FAZ, FAZ-PN, FAZ-HS Page 2.174
 - MCB FAZ-T Page 2.227
 - MCB FAZ-DC Page 2.234
 - MCB FAZ-NA/RT Page 2.239
 - MCB FAZ-NA-DC Page 2.259
 - MCB FAZ-RT-DC Page 2.263
 - MCB FAZ6 Page 2.271
 - MCB AZ Page 2.287























• Photovoltaic - DC-Disconnection	
– DC Switch-Disconnecter.....	Page 1.299
• Main Load Disconnecter Switch (Isolator) IS.....	Page 2.305
• Accessories for Protective Devices	
– Accessories for RCDs, MCBs, Combined RCD/MCB Devices	Page 2.309
– Accessories for Add-on Residual Current Protection Unit FBHmV.....	Page 2.325
– Accessories for MCB AZ.....	Page 2.326
– Accessories for MCB FAZ-...-NA, -RT	Page 2.330
– Terminal Covers.....	Page 2.333
– Automatic restarting device Z-FW	Page 2.334
• Busbar Systems	
– Busbar System xEffect BB-EV	Page 2.337
– UL489-Busbar System Z-BB/UL	Page 2.341
– UL508-Busbar System BB-UL.....	Page 2.345
– UL489-Busbar System Z-SV/UL	Page 2.349
– AFDD Busbar EVG-2PHAS/4AFDD	Page 2.354
– Busbar System Z-VPS, Z-VPL for auxiliary contact	Page 2.356

Residual Current Devices - General Data

Short description of the most important RCD types

Symbol	Description
	Eaton standard. Suitable for outdoor installation (distribution boxes for outdoor installation and building sites) up to -25° C.
	Conditionally surge-current proof (>250 A, 8/20 μs) for general application.
	Type AC: AC current sensitive RCCB
	Type A: AC and pulsating DC current sensitive RCCB, not affected by smooth DC fault currents up to 6 mA
	Type F: AC and pulsating DC current sensitive RCCB, trips also at frequency mixtures (10 Hz, 50 Hz, 1000 Hz), min. 10 ms time-delayed, min. 3 kA surge current proof, higher load capacity with smooth DC fault currents up to 10 mA
	Frequency range up to 20 kHz
	Trips also at frequency mixtures (10 Hz, 50 Hz, 1000 Hz)
	Type B: All-current sensitive RCD switchgear for applications where DC fault currents may occur. Non-selective, non-delayed. Protection against all kinds of fault currents.
	Type B+: All-current sensitive RCD switchgear for applications where DC fault currents may occur. Non-selective, non-delayed. Protection against all kinds of fault currents. Provides enhanced fire safety.
	RCD of type G (min 10 ms time delay) surge current-proof up to 3 kA. For system components where protection against unwanted tripping is needed to avoid personal injury and damage to property. Also for systems involving long lines with high capacitive reactance. Some versions are sensitive to pulsating DC. Some versions are available in all-current sensitive design.
	RCD of type S (selective, min 40 ms time delay) surge current-proof up to 5 kA. Mainly used as main switch, as well as in combination with surge arresters. This is the only RCD suitable for series connection with other types if the rated tripping current of the downstream RCD does not exceed one third of the rated tripping current of the device of type S. Some versions are sensitive to pulsating DC. Some versions are available in all-current sensitive design.

Kind of residual current and correct use of RCD Types

Kind of current	Current profile	Correct use / application field of RCCB types						Tripping current
		AC	A	F	B	/ B+		
Sinusoidal AC residual current							0.5 to 1.0 $I_{\Delta n}$	
Pulsating DC residual current (positive or negative half-wave)		-					0.35 to 1.4 $I_{\Delta n}$	
Cut half-wave current		-					Lead angle 90°: 0.25 to 1.4 $I_{\Delta n}$ Lead angle 135°: 0.11 to 1.4 $I_{\Delta n}$	
Half-wave with smooth DC current of 6 mA		-					max. 1.4 $I_{\Delta n}$ + 6 mA	
Half-wave with smooth DC current of 10 mA		-	-				max. 1.4 $I_{\Delta n}$ + 10 mA	
Smooth DC current		-	-	-			0.5 to 2.0 $I_{\Delta n}$	

Tripping time

Break time and non-actuating time for alternating residual currents (r.m.s. values) for type AC and A RCCB

Classification	$I_{\Delta n}$ mA		$I_{\Delta n}$	$2xI_{\Delta n}$	$5xI_{\Delta n}$	$5 x I_{\Delta n}$ or 0.25A	500A
Standard RCD Conditionally surge current-proof 250 A	≤30	Max. tripping time (s)	0.3	0.15		0.04	0.04
Standard RCD Conditionally surge current-proof 250 A	>30	Max. tripping time (s)	0.3	0.15	0.04		0.04
RCCB Type G (Short-time-delay) Surge current-proof 3 kA	30	Min. non actuating time(s) Max. tripping time (s)	0.01 0.3	0.01 0.15		0.01 0.04	0.01 0.04
RCCB Type G (Short-time-delay) Surge current-proof 3 kA	>30	Min. non actuating time(s) Max. tripping time (s)	0.01 0.3	0.01 0.15	0.01 0.04		0.01 0.04
RCCB Type S (Selective) Surge current-proof 5 kA	>30	Min. non actuating time(s) Max. tripping time (s)	0.13 0.5	0.06 0.2	0.05 0.15		0.04 0.15

Break time for half-wave pulsating residual currents (r.m.s. values) for type A RCCB

Classification	$I_{\Delta n}$ mA		$1.4xI_{\Delta n}$	$2xI_{\Delta n}$	$2.8xI_{\Delta n}$	$4xI_{\Delta n}$	$7 x I_{\Delta n}$ 0.35 A	0.5 A	350A
Standard RCD Conditionally surge current-proof 250 A	<30	Max. tripping time (s)		0.3		0.15		0.04	0.04
Standard RCD Conditionally surge current-proof 250 A	30	Max. tripping time (s)	0.3		0.15		0.04		0.04
Standard RCD Conditionally surge current-proof 250 A	>30	Max. tripping time (s)	0.3		0.15		0.04		0.04
RCCB Type G (Short-time-delay) Surge current-proof 3 kA	30	Max. tripping time (s)	0.3		0.15		0.04		0.04
RCCB Type G (Short-time-delay) Surge current-proof 3 kA	>30	Max. tripping time (s)	0.3		0.15		0.04		0.04
RCCB Type S (Selective) Surge current-proof 5 kA	>30	Max. tripping time (s)	0.5		0.2		0.15		0.15

Tripping Characteristics (IEC/EN 61008)

Tripping characteristics, tripping time range and selectivity of instantaneous, surge current-proof „G“ and surge current-proof - selective „S“ residual current devices.

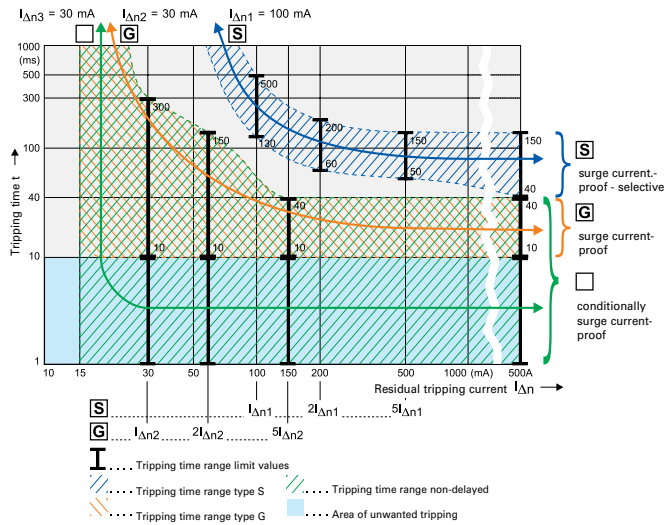

IEC 60364-4-41 deals with additional protection: The use of RCDs with a rated residual operating current not exceeding 30 mA, is recognized in a.c. systems as additional protection in the event of failure of the provision for basic protection and/or the provision for fault protection or carelessness by users.

This means when using RCDs for fault current/residual current protection two RCDs must be connected in series.

Testing:

RCDs with tripping time delay (Types -G and -S) may be function tested with conventional testing equipment which must be set according to the instructions for operation of the testing device. Due to reasons inherent in the measuring process, the tripping time determined in this way may be longer than expected in accordance with the specifications of the manufacturer of the measuring instrument.

However, the device is ok if the result of measurement is within the time range specified by the manufacturer of the measuring instrument.

Applications with frequency converters:

Due to the currents flowing off through the filters (designated IF), the sum of currents through the RCD is not exactly zero, which causes unwanted tripping.

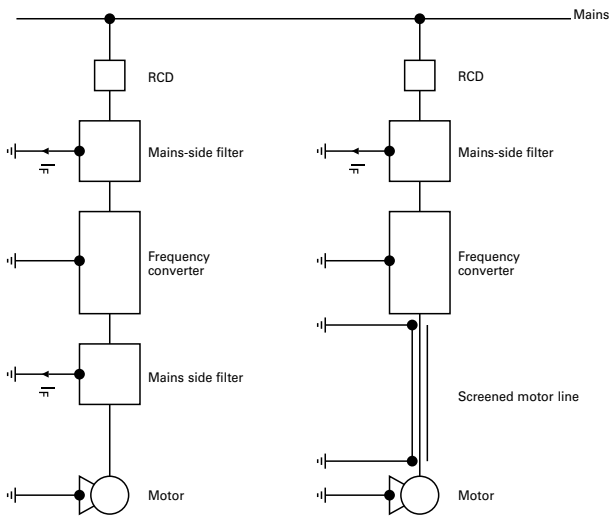

Frequency converters are used in a wide variety of systems and equipment requiring variable speed, such as lifts, escalators, conveyor belts, and large washing machines. Using them for such purposes in circuits with conventional residual current devices causes frequent problems with unwanted tripping.

The technical root cause of this phenomenon is the following: Fast switching operations involving high voltages cause high interference levels which propagate through the lines on the one hand, and in the form of interfering radiation on the other. In order to eliminate this problem, a mains-side filter (also referred to as input filter or EMC-filter) is connected between the RCD and frequency converter. The anti-interference capacitors in the filters produce discharge currents against earth which may cause unwanted tripping of the RCD due to the apparent residual currents. Connecting a filter on the output side between frequency converter and 3-phase AC motor results in the same behaviour.

Tripping characteristic

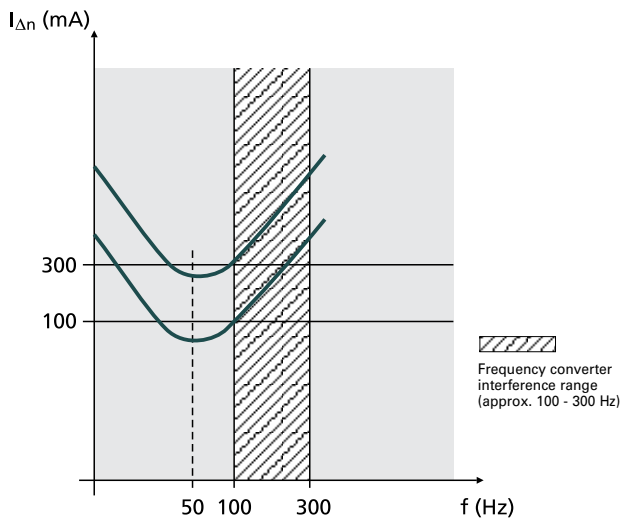

This sample tripping characteristic of a 100 mA RCD and a 300 mA RCD shows the following: In the frequency range around 50 Hz, the RCDs trip as required (50 - 100 % of the indicated $I_{\Delta n}$).

In the range shown hatched in the diagram, i. e. from approx. 100 to 300 Hz, unwanted tripping occurs frequently due to the use of frequency converters. Type F RCCBs are designed to reliably sense higher frequency residual currents, which leads to an enormous increase in the reliability and availability of electrical systems.

Therefore, we recommend to use RCDs designed for applications with frequency converter!

These special residual current devices can be recognised by an extension of the type designation („-F“). They meet the requirements of compatibility between RCDs and frequency converters with respect to unwanted tripping.

Eaton stands for highest availability of your system also in applications where frequency drives are used. Therefore a full suite of Type F RCCBs (mechanical and digital assisted) are available in all feasible ratings to assist you in your application needs.

Our RCDs of type „-F“ are characterized by:

- Improved capabilities of reliably sensing residual currents up to 1 kHz
- Improved capabilities of withstanding 10 mA DC offset
- 10 ms short time delay minimum (G/F)
- Surge current proofness of 3 kA (G/F) and 5 kA (S/F)

wa_sg08020_1



Description

- Line voltage independent RCCB for fault protection, additional protection as well as fire protection
- Additional digital functionality for improved system availability as well as system monitoring
- Live status of the system communicated through an integrated auxiliary contact as well as on the device itself
- Digital assisted sensing of residual current to achieve highest levels of system availability
- FRCdM reduces running costs due to a yearly test interval
- Fault current tripping indicator enables to determine the tripping reason
- Comprehensive accessories available
- Suitable to be put into rail rolling stock applications due to additional certification

$I_n/I_{\Delta n}$ (A)	Operating frequency (Hz)	Type Designation	Article No.	Units per package
---------------------------	-----------------------------	---------------------	-------------	----------------------

Type G/A**Surge current-proof 3 kA, sensitive to residual pulsating DC, Type G/A (ÖVE E 8601)** **4-poles**

25/0.03	50	FRCdM-25/4/003-G/A	168646	1/30
25/0.1	50	FRCdM-25/4/01-G/A	501257	1/30
25/0.3	50	FRCdM-25/4/03-G/A	168647	1/30
40/0.03	50	FRCdM-40/4/003-G/A	168648	1/30
40/0.1	50	FRCdM-40/4/01-G/A	501261	1/30
40/0.3	50	FRCdM-40/4/03-G/A	168649	1/30
63/0.03	50	FRCdM-63/4/003-G/A	168650	1/30
63/0.1	50	FRCdM-63/4/01-G/A	501268	1/30
63/0.3	50	FRCdM-63/4/03-G/A	168651	1/30
80/0.03	50	FRCdM-80/4/003-G/A	168634	1/30
80/0.1	50	FRCdM-80/4/01-G/A	501275	1/30
80/0.3	50	FRCdM-80/4/03-G/A	168635	1/30

wa_sg08020_1

**Type S/A****Selective + surge current-proof typ. 5 kA, sensitive to residual pulsating DC, Type S/A** **4-poles**

40/0.1	50	FRCdM-40/4/01-S/A	501263	1/30
40/0.3	50	FRCdM-40/4/03-S/A	168637	1/30
63/0.1	50	FRCdM-63/4/01-S/A	501270	1/30
63/0.3	50	FRCdM-63/4/03-S/A	168638	1/30
80/0.1	50	FRCdM-80/4/01-S/A	501277	1/30
80/0.3	50	FRCdM-80/4/03-S/A	168639	1/30

wa_sg07020_1



$I_n/I_{\Delta n}$ (A)	Operating frequency (Hz)	Type Designation	Article No.	Units per package
---------------------------	-----------------------------	---------------------	-------------	----------------------

Type G/F

Surge current-proof 3 kA, sensitive to residual pulsating DC, frequency mixture and 10 mA DC offset, Type G/F (ÖVE E 8601)  



wa_sg08020_1



4-poles

25/0.03	50	FRCdM-25/4/003-G/F	501256	1/30
25/0.1	50	FRCdM-25/4/01-G/F	501258	1/30
25/0.3	50	FRCdM-25/4/03-G/F	501259	1/30
40/0.03	50	FRCdM-40/4/003-G/F	501260	1/30
40/0.1	50	FRCdM-63/4/01-G/F	501262	1/30
40/0.3	50	FRCdM-40/4/03-G/F	501265	1/30
63/0.03	50	FRCdM-63/4/003-G/F	501267	1/30
63/0.1	50	FRCdM-63/4/01-G/F	501269	1/30
63/0.3	50	FRCdM-63/4/03-G/F	501272	1/30
80/0.03	50	FRCdM-80/4/003-G/F	501274	1/30
80/0.1	50	FRCdM-80/4/01-G/F	501276	1/30
80/0.3	50	FRCdM-80/4/03-G/F	501279	1/30

Type S/F

Selective current-proof 5 kA, selective, sensitive to residual pulsating DC, frequency mixture and 10 mA DC offset, Type S/F (ÖVE E 8601)  

wa_sg07020_1



4-poles

40/0.1	50	FRCdM-40/4/01-S/F	501264	1/30
40/0.3	50	FRCdM-40/4/03-S/F	501266	1/30
63/0.1	50	FRCdM-63/4/01-S/F	501271	1/30
63/0.3	50	FRCdM-63/4/03-S/F	501273	1/30
80/0.1	50	FRCdM-80/4/01-S/F	501278	1/30
80/0.3	50	FRCdM-80/4/03-S/F	501280	1/30

Type R PHASE OUT

Surge current-proof 3 kA, X-ray application, Type R 

wa_sg06920_1



4-poles

63/0.03	50	FRCdM-63/4/003-R	168636	1/30
---------	----	------------------	--------	------

Specifications | Residual Current Devices FRCdM

Description

Design

- Digital Residual Current Circuit Breakers (RCCBs)
- Designed and suitable to be put into an xEffect-System
- Twin-purpose terminal (lift/open-mouthed) above and below
- Contact position indicator red - green
- Tripping indicator white - blue
- Additional safety due:
 - possibility to seal the toggle
 - possibility to lock the toggle
- The device functions irrespective of the position of installation

Accessories

- Busbar positioning optionally above or below
- Free terminal space despite installed busbar
- Auxiliary contacts to be mounted onto the device:
 - Universal tripping signal switch, also suitable for FAZ, FRBmM-1N
 - Auxiliary switch Z-HK can be mounted subsequently

Additional information for the application

- Delayed types suitable for being used with standard fluorescent tubes with or without electrical ballast
 - 30mA-RCCBs: 30 units per phase conductor
 - 100mA RCCBs: 90 units per phase conductor

Note: Depending on the fluorescent lamp manufacturer, partly more units possible. Symmetrical allocation of the fluorescent lamp ballasts on all phases favorably. Please still consider the technical data provided by the manufacturer of the lamps.
- Tripping is line voltage independent (VI) and therefore suitable for all BA-classes.

The RCD is suitable for fault protection, additional protection, fire protection within the regulations of the applicable wiring regulations (e.g.: IEC/EN 60364)
- Independent supply side except applications according to connection diagram (2)
- The 4-pole device can also be used for 3-pole and 2 pole applications. Please refer to published connection diagrams

Test Button

- The test button "T" must be pressed once every 12 months. The system operator must be informed of this obligation and his responsibility in a way that can be proven.

Under special conditions (e.g.: dampy and/or dusty environments, environments with polluting and/or corroding conditions, environments with large temperature fluctuations, installations with a risk of overvoltage due to switching of equipment and/or atmospheric discharges, portable equipment, ...), it's recommended to test in monthly intervals. Regulations according IEC/EN 60364 or wiring regulations still apply.

If red and yellow LED are present simultaneously, please press the test button and follow the instruction stated in the instruction leaflet.
- The test button "T" tests the function of the RCCB itself. This test does not measure a "suitable" fault loop or if requirements of such are kept. Testing your fault loop (earth rod resistance, continuity of fault loop,...) requires special tests performed separately.

Status Indication of digital RCCB





- System status as seen on the RCCB:
 - The green LED becomes active at 0-30% $I_{\Delta n}$
 - The yellow LED becomes active at 30-50% $I_{\Delta n}$, as well as the integrated auxiliary contact
 - The red LED becomes active at >50% $I_{\Delta n}$
 - Tolerance of system status indication: $\pm 5\%$

- The internal potential-free auxiliary contact (NO, terminals 13/14) for external communication is actuated starting at 30 $I_{\Delta n}$. The contact will stay "active" even after the breaker trips

The integrated auxiliary contact provides basic insulation from the main terminals of the RCCB. Without any additional protective measures (eg.: isolation transformer 1:1 according to IEC/EN 60664) the integrated auxiliary contact may only be supplied from the terminals 2, 4, 6, N. See also connection diagrams (2) and (3) for further details

- **Type A:** These types are capable of sensing pulsating residual currents and are not negatively affected by a DC overlay of up to 6mA. These devices (depended on the range) are also available as:
 - G/A short time delayed devices which are surge current proof up to 3kA. These devices enable a reliable and safe installation with increased system availability
 - S/A selective RCCBs with improved surge current capabilities up to 5kA. These devices are selective (conditions apply) to other RCDs and enable special applications and root installations.
- **Type F:** These types are capable of sensing pulsating residual currents, residual currents up to 1kHz and are not negatively affected by a DC overlay of up to 10mA. They also offer improved availability of your system. These devices (depended on the range) are also available as:
 - G/F short time delayed devices which are surge current proof up to 3kA. These devices enable a reliable and safe installation with increased system availability
 - S/F selective RCCBs with improved surge current capabilities up to 5kA. These devices are selective (conditions apply) to other RCDs and enable special applications and root installations.
- **Type G:** G Types offer a 10ms time delayed tripping curve and surge current proof capabilities up to 3kA and are highly recommended to be used for applications and installations where system availability is an important factor. Since "G" states a tripping curve and not a sensitivity, these devices (depended on the range) will be found as
 - AC sensitive devices (-G)
 - A Type RCCBs (-G/A)
 - F Type RCCBs (-G/F)
 - B/Bfq/B+ Type RCCBs (-G/B(fq/+))
- **Type S:** S Types offer a 40ms time delayed tripping curve and surge current proof capabilities up to 5kA and are know as "selective" types. These devices are mainly used in root applications with additional RCDs deployed in series in the system. Since "S" states a tripping curve and not a sensitivity, these devices (depended on the range) will be found as:
 - AC sensitive devices (-S)
 - A Type RCCBs (-S/A)
 - F Type RCCBs (-S/F)
 - B/Bfq/B+ Type RCCBs (-S/B(fq/+))

Local status indication provided by the digital RCCB

LED signals		red / yellow / green
Permanent light green		Normal operation
Permanent light yellow		The currently measured residual current is higher than 30% I Δ n. The system is currently drawing a fault current, and actions should be taken accordingly.
Permanent light red		The currently measured residual current is higher than 50% I Δ n. The system is currently drawing a critical amount of fault current, and actions should be taken immediately.
Flashing yellow/red		Please press the test button (T). If the LEDs are still present, please refer to the instruction leaflet.

Remotely communicated status indication provided by the digital RCCB

Integrated contact for use in control circuits. Please adhere to the electrical limits of the NO contacts (0,25A ohmic load @ 240V). Without any additional protective measures (eg.: isolation transformer 1:1 according to IEC/EN 60664) the integrated auxiliary contact may only be supplied from the terminals 2, 4, 6, N. See also connection diagrams (2) and (3) for further details.

Accessories:

Auxiliary contact to be mounted on the left side	Z-HK	248432
Auxiliary contact to be mounted on the right side	Z-NHK	248434
Automatic restarting device	Z-FW/LP	248296
	Z-FW-LPD	265244
	Z-FW-MO	284730
	Z-FW-LP/MO	290171
	Z-FW-LPD/MO	290172
I Δ n testing module	Z-FW/003	248298
	Z-FW/010	248299
	Z-FW/030	248300
Terminal cover 4-poles	Z-RC/AK-4TE	101062

Technical Data

		FRCdM
Electrical		
Design according to		IEC/EN 61008 Type G (G/A, G/F,...) acc. to ÖVE 8601
Classified according to		Type F acc. to IEC/EN 62423
Current test marks as printed onto the device		IEC 61373, EN 45545-2
Tripping		instantaneous
Type G , R		10 ms delay
Type S		40 ms delay - with selective disconnecting function
Rated voltage	U_n	240/415 V AC, 50 Hz
Limits of operation voltage digital functions		50 – 264V AC
Limits of operation voltage test circuit		
Rated tripping current	$I_{\Delta n}$	30, 100, 300 mA
Sensitivity		AC and pulsating DC
Rated insulation voltage	U_i	440 V
Rated impulse withstand voltage	U_{imp}	4 kV (1.2/50 μ s)
Rated short circuit capacity	I_{cn}	10 kA with back-up fuse
Peak withstand current		
Type G (G/A, G/F)		3 kA (8/20 μ s) surge current-proof
Type S (S/A, S/F)		5 kA (8/20 μ s) selective + surge current-proof
Rated breaking capacity or rated fault breaking capacity	I_m $I_{\Delta m}$	
$I_n = 25-40$ A		500 A
$I_n = 63$ A		630 A
$I_n = 80$ A		800 A
Endurance		
electrical components		$\geq 4,000$ operating cycles
mechanical components		$\geq 20,000$ operating cycles
Mechanical		
Frame size		45 mm
Device height		80 mm
Device width		70 mm (4MU)
Mounting		quick fastening with 2 lock-in positions on DIN rail IEC/EN 60715
Degree of protection, built-in		IP40
Degree of protection in moisture-proof enclosure		IP54
Upper and lower terminals		open mouthed/lift terminals
Terminal protection		finger and hand touch safe, DGUV VS3, EN 50274
Terminal capacity		1.5 - 35 mm ² single wire 2 x 16 mm ² multi wire
Terminal screw		M5 (with slotted screw acc. to EN ISO 4757-Z2, Pozidriv PZ2)
Terminal torque		2 - 2.4 Nm
Busbar thickness		0.8 - 2 mm
Operation temperature		-25°C to +40°C (for higher values see table on ambient temperature)
Storage- and transport temperature		-35°C to +60°C
Resistance to climatic conditions		acc. to IEC/EN 61008
Contact position indicator		red / green
Tripping indicator		white / blue
Internal contact		
Rated breaking capacity @ 30 V DC (resistive load)		2 A
Rated breaking capacity @ 240 V AC (resistive load)		0.25 A
Maximum switching power (resistive load)		60 W
Maximum switching voltage DC		220 V
Maximum switching voltage AC		240 V
Maximum switching current		2 A
Minimum switching capacity (reference value)		10 μ A, 10 mV DC
Endurance		
Electrical (at 20 cpm) 2 A 30 V DC resistive load)		$>10^5$
Electrical (at 20 cpm) 1 A 30 V DC resistive load)		$>5 \times 10^5$
Terminal capacity		0.25 - 1.5 mm ²

Connection diagram

4-poles

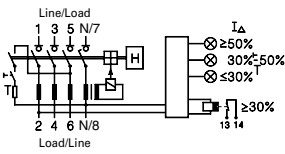

① Without use of auxiliary contact line/load side free selectable

4-poles

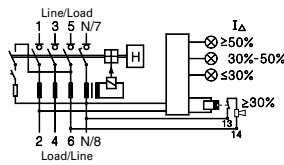

② Signalisation without Isolation Transformer 1:1 (IEC/EN 60664)

4-poles

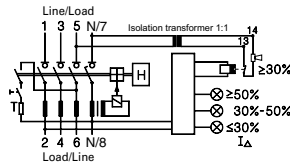

③ Signalisation with Isolation Transformer 1:1 (IEC/EN 60664)

Dimensions (mm)

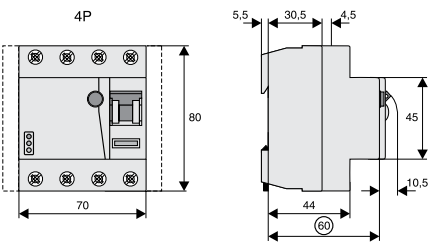

Correct connection

30, 300mA Types:

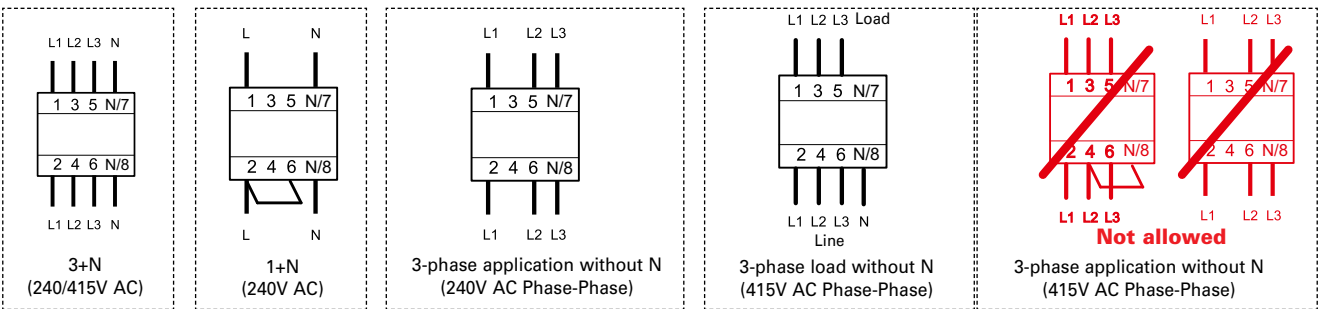

Electronic works within 50-264V AC!

- Disconnect load side of the switch gear, if you make a insulation test of the installation!

Internal Resistance FRCdM

At room temperature (single pole)

In [A]	Z* [mΩ]
25	0.66
40	0.64
63	0.64
80	0.62

* 50Hz

Power Loss at In FRCdM

(entire unit)

In [A]	P* [W]
25	2.2
40	3.8
63	8.5
80	12.9

* 50Hz

Impact of ambient temperature on the maximum permanent current allowed (A) FRCdM type A and F

Ambient temperature	25A	40A	63A	80A
	4p	4p	4p	4p
40°	25	40	63	80
45°	25	35	55	71
50°	25	30	47	63
55°	23	28	38	54
60°	20	25	30	45
65°	-	-	-	-
70°	-	-	-	-
75°	-	-	-	-

Note: Please make sure that these values are not exceeded and that any upstream thermal overload protection switches off in time.

Max. back-up fuse FRCDM

Rating In [A]	Fuses		MCB's (Characteristic B/C)	
	Short Circuit [A]	Overload [A]	Short Circuit [A]	Overload [A]
25	63 gG/gI	25 gG/gI	FAZ-C40	FAZ-C25
40	63 gG/gI	40 gG/gI	FAZ-C40	FAZ-C40
63	63 gG/gI	63 gG/gI	FAZ-C40	FAZ-C40
80	80 gG/gI	80 gG/gI	-	-

Important:

In the case that the maximal possible operating current of the electrical installation don't exceed the rated current of the RCD only short circuit protection must be implemented. Overload protection must be implemented in the case if the maximal possible operating current of the electrical installation can exceed the rated current of the RCD.

wa_sg04320_1





Description

- All current sensitive RCCBs to fulfil highest safety standards
- Line voltage independent 2 and 4 pole RCCB for fault protection, additional protection as well as fire protection
- As also stated in IEC/EN 62423, the B sensitivity relies on line voltage
- Additional digital functionality for improved system availability as well as system monitoring
- Live status of the system communicated through an integrated auxiliary contact as well as on the device itself
- Digital assisted sensing of residual current to achieve highest levels of system availability
- FRCdM reduce running costs due to a yearly test interval
- Fault current tripping indicator enables to determine the tripping reason
- Comprehensive accessories available
- Suitable to be put into rail rolling stock applications due to additional certification
- B+ types also meet the requirements of superior fire-protection systems according to VDE 0664-400

$I_n/I_{\Delta n}$ (A)	Operating frequency (Hz)	Type Designation	Article No.	Units per package
---------------------------	-----------------------------	---------------------	-------------	----------------------

Type G/B

Surge current-proof 3 kA, AC-DC sensitive, Type G/B (ÖVE E 8601)   

wa_sg10420_1



2-Pole (4MU)

25/0.03	50	FRCdM-25/2/003-G/B	300638	1/30
25/0.3	50/60	FRCdM-25/2/03-G/B	302638	1/30
40/0.03	50	FRCdM-40/2/003-G/B	300639	1/30
40/0.3	50/60	FRCdM-40/2/03-G/B	302639	1/30
63/0.03	50	FRCdM-63/2/003-G/B	300640	1/30
63/0.3	50/60	FRCdM-63/2/03-G/B	302640	1/30



wa_sg05320_1



4-poles

25/0.03	50	FRCdM-25/4/003-G/B	167892	1/30
25/0.3	50/60	FRCdM-25/4/03-G/B	167896	1/30
40/0.03	50	FRCdM-40/4/003-G/B	167893	1/30
40/0.3	50/60	FRCdM-40/4/03-G/B	167897	1/30
63/0.03	50	FRCdM-63/4/003-G/B	167894	1/30
63/0.3	50/60	FRCdM-63/4/03-G/B	167898	1/30

Type S/B

Selective + surge current-proof 5 kA, Type S/B   

wa_sg11620_1



2-Pole (4MU)

25/0.3	50	FRCdM-25/2/03-S/B	302635	1/30
40/0.3	50	FRCdM-40/2/03-S/B	302636	1/30
63/0.3	50	FRCdM-63/2/03-S/B	302637	1/30

wa_sg05920_1



4-poles

25/0.3	50	FRCdM-25/4/03-S/B	167900	1/30
40/0.3	50	FRCdM-40/4/03-S/B	167901	1/30
63/0.3	50	FRCdM-63/4/03-S/B	167902	1/30

Type G/Bfq

Surge current-proof 3 kA, AC-DC sensitive, Type G/Bfq (ÖVE E 8601)   

wa_sg09220_1



4-poles

25/0.03	50	FRCdM-25/4/003-G/Bfq	179530	1/30
25/0.03	50	FRCdM-25/4/003-G/Bfq-400	306415	1/30
25/0.3	50/60	FRCdM-25/4/03-G/Bfq	167904	1/30
40/0.03	50	FRCdM-40/4/003-G/Bfq	179531	1/30
40/0.03	50	FRCdM-40/4/003-G/Bfq-400	306418	1/30
40/0.3	50/60	FRCdM-40/4/03-G/Bfq	167905	1/30
63/0.03	50	FRCdM-63/4/003-G/Bfq	179532	1/30
63/0.03	50	FRCdM-63/4/003-G/Bfq-400	306421	1/30
63/0.3	50/60	FRCdM-63/4/03-G/Bfq	167906	1/30

$I_n/I_{\Delta n}$ (A)	Operating frequency (Hz)	Type Designation	Article No.	Units per package
---------------------------	-----------------------------	---------------------	-------------	----------------------

Type S/Bfq

Selective + surge current-proof 5 kA, Type S/Bfq 

wa_sg06520_1



4-poles

25/0.3	50	FRCdM-25/4/03-S/Bfq	167908	1/30
40/0.3	50	FRCdM-40/4/03-S/Bfq	167909	1/30
63/0.3	50	FRCdM-63/4/03-S/Bfq	167910	1/30

Type G/B+

Surge current-proof 3 kA, Type G/B+ (ÖVE E 8601) 

wa_sg04420_1



4-poles

25/0.03	50	FRCdM-25/4/003-G/B+	167880	1/30
25/0.03	50	FRCdM-25/4/003-G/B+-400	306422	1/30
25/0.3	50/60	FRCdM-25/4/03-G/B+	167884	1/30
40/0.03	50	FRCdM-40/4/003-G/B+	167881	1/30
40/0.03	50	FRCdM-40/4/003-G/B+-400	306423	1/30
40/0.3	50/60	FRCdM-40/4/03-G/B+	167885	1/30
63/0.03	50	FRCdM-63/4/003-G/B+	167882	1/30
63/0.03	50	FRCdM-63/4/003-G/B+-400	306424	1/30
63/0.3	50/60	FRCdM-63/4/03-G/B+	167886	1/30

Type S/B+

Selective + surge current-proof 5 kA, Type S/B+ 

wa_sg05020_1





4-poles

25/0.3	50	FRCdM-25/4/03-S/B+	167888	1/30
40/0.3	50	FRCdM-40/4/03-S/B+	167889	1/30
63/0.3	50	FRCdM-63/4/03-S/B+	167890	1/30

$I_n/I_{\Delta n}$ (A)	Operating frequency (Hz)	Type Designation	Article No.	Units per package
---------------------------	-----------------------------	---------------------	-------------	----------------------

Type G/B

Surge current-proof 3 kA, AC-DC sensitive, Type G/B (ÖVE E 8601)   

wa_sg09720_1



4-poles

25/0.03	60	FRCdM-25/4/003-G/B/60Hz	180418	1/30
40/0.03	60	FRCdM-40/4/003-G/B/60Hz	180421	1/30
63/0.03	60	FRCdM-63/4/003-G/B/60Hz	180424	1/30

Type G/Bfq

Surge current-proof 3 kA, AC-DC sensitive, Type G/Bfq (ÖVE E 8601)   

wa_sg09920_1



4-poles

25/0.03	60	FRCdM-25/4/003-G/Bfq/60Hz	180420	1/30
40/0.03	60	FRCdM-40/4/003-G/Bfq/60Hz	180423	1/30
63/0.03	60	FRCdM-63/4/003-G/Bfq/60Hz	180426	1/30

Type G/B+

Surge current-proof 3 kA, Type G/B+ (ÖVE E 8601)   kHz

wa_sg04720_1



4-poles

25/0.03	60	FRCdM-25/4/003-G/B+/60Hz	180419	1/30
25/0.3	50/60	FRCdM-25/4/03-G/B+	167884	1/30
40/0.03	60	FRCdM-40/4/003-G/B+/60Hz	180422	1/30
40/0.3	50/60	FRCdM-40/4/03-G/B+	167885	1/30
63/0.03	60	FRCdM-63/4/003-G/B+/60Hz	180425	1/30
63/0.3	50/60	FRCdM-63/4/03-G/B+	167886	1/30

Specifications | Residual Current Devices FRCdM - digital, Type B, Bfq and B+

Description

Design

- Digital Residual Current Circuit Breakers (RCCBs)
- Designed and suitable to be put into an xEffect-System
- Twin-purpose terminal (lift/open-mouthed) above and below
- Contact position indicator red - green
- Tripping indicator white - blue
- Additional safety due:
 - possibility to seal the toggle
 - possibility to lock the toggle
- The device functions irrespective of the position of installation

Accessories

- Busbar positioning optionally above or below. (Please adhere to the supply side of the RCCB)
- Free terminal space despite installed busbar
- Auxiliary contacts to be mounted onto the device:
 - Universal tripping signal switch, also suitable for FAZ, FRBmM-1N
 - Auxiliary switch Z-HK can be mounted subsequently

Additional information for the application

- Delayed types suitable for being used with standard fluorescent tubes with or without electronical ballast
 - 30mA-RCCBs: 30 units per phase conductor
 - 100mA RCCBs: 90 units per phase conductor

Note: Depending on the fluorescent lamp manufacturer, partly more units possible. Symmetrical allocation of the fluorescent lamp ballasts on all phases favorably. Please still consider the technical data provided by the manufacturer of the lamps.
- Tripping is line voltage independent (VI) and therefore suitable for all BA-classes.

The RCD is suitable for fault protection, additional protection, fire protection within the regulations of the applicable wiring regulations (e.g.: IEC/EN 60364)
- Independent supply side except applications according to connection diagram (2))
- The 4-pole device can also be used for 3-pole and 2 pole applications. Please refer to published connection diagrams

Test Button

- The test button "T" must be pressed once every 12 months. The system operator must be informed of this obligation and his responsibility in a way that can be proven.

Under special conditions (e.g.: damply and/or dusty environments, environments with polluting and/or corroding conditions, environments with large temperature fluctuations, installations with a risk of overvoltage due to switching of equipment and/or atmospheric discharges, portable equipment, ...), it's recommended to test in monthly intervals. Regulations according IEC/EN 60364 or wiring regulations still apply.

If red and yellow LED are present simultaneously, please press the test button and follow the instruction stated in the instruction leaflet.
- The test button "T" tests the function of the RCCB itself. This test does not measure a "suitable" fault loop or if requirements of such are kept. Testing your fault loop (earth rod resistance, continuity of fault loop,...) requires special tests performed separately.

Status Indication of digital RCCB

- System status as seen on the RCCB:
 - The green LED becomes active at 0-30% $I_{\Delta n}$
 - The yellow LED becomes active at 30-50% $I_{\Delta n}$, as well as the integrated auxiliary contact
 - The red LED becomes active at >50% $I_{\Delta n}$
 - Tolerance of system status indication: $\pm 5\%$

- The internal potential-free auxiliary contact (NO, terminals 13/14) for external communication is actuated starting at 30 $I_{\Delta n}$. The contact will stay "active" even after the breaker trips





The integrated auxiliary contact provides basic insulation from the main terminals of the RCCB. Without any additional protective measures (eg.: isolation transformer 1:1 according to IEC/EN 60664) the integrated auxiliary contact may only be supplied from the terminals 2, 4, 6, N. See also connection diagrams (2) and (3) for further details.

- **Type B (fq, +):** These types offer the highest safety levels in electrical systems due to their all-current sensitivity and best in class reliability and system availability. Special type B from Eaton are available:
 - B+ limit the possibility of electrical ignited fires and should be considered for fire hazard applications as also mentioned in VDE-0664-400
 - Bfq are capable of reliably sensing residual currents up to 50 kHz
- **Type G:** G Types offer a 10 ms time delayed tripping curve and surge current proof capabilities up to 3 kA and are highly recommended to be used for applications and installations where system availability is an important factor. Since "G" states a tripping curve and not a sensitivity, these devices (dependent on the range) will be found as:
 - B/Bfq/B+ Type RCCBs (-G/B(fq/+))
- **Type S:** S Types offer a 40ms time delayed tripping curve and surge current proof capabilities up to 5kA and are known as "selective" types. These devices are mainly used in root applications with additional RCDs deployed in series in the system.

Since "S" states a tripping curve and not a sensitivity, these devices (dependent on the range) will be found as:

 - B/Bfq/B+ Type RCCBs (-S/B(fq/+))

Local status indication provided by the digital RCCB

LED signals		red / yellow / green
Permanent light green		Normal operation
Permanent light yellow		The currently measured residual current is higher than 30% I Δ n. The system is currently drawing a fault current, and actions should be taken accordingly.
Permanent light red		The currently measured residual current is higher than 50% I Δ n. The system is currently drawing a critical amount of fault current, and actions should be taken immediately.
Flashing yellow/red		Please press the test button (T). If the LEDs are still present, please refer to the instruction leaflet.

Remotely communicated status indication provided by the digital RCCB

Integrated contact for use in control circuits. Please adhere to the electrical limits of the NO contacts (0,25A ohmic load @ 240V). Without any additional protective measures (eg.: isolation transformer 1:1 according to IEC/EN 60664) the integrated auxiliary contact may only be supplied from the terminals 2, 4, 6, N. See also connection diagrams (2) and (3) for further details.

Accessories:

Auxiliary contact to be mounted on the left side	Z-HK	248432
Auxiliary contact to be mounted on the right side	Z-NHK	248434
Automatic restarting device	Z-FW/LP	248296
	Z-FW-LPD	265244
Remote control unit	Z-FW-MO	284730
Sets (Device + remote control unit)	Z-FW-LP/MO	290171
	Z-FW-LPD/MO	290172
I Δ n testing module	Z-FW/003	248298
	Z-FW/010	248299
	Z-FW/030	248300
Terminal cover 4-poles	Z-RC/AK-4TE	101062

Technical Data

		FRCdM Type B, Bfq and B+
Electrical		
Design according to		Types B and Bfq acc. to IEC/EN 61008, IEC/EN 62423 Types B+ acc. to VDE 0664-400, formerly known as VDE V 0664-110 Type G/B, G/Bfq and G/B+ additional acc. to ÖVE E 8601 IEC 61373, EN 45545-2
Classified according to		
Current test marks as printed onto the device		
Tripping		
Type G		10 ms delay @ 50 Hz
Type S		40 ms delay @ 50 Hz - with selective disconnecting function
Rated voltage	U_n	240/415 V AC 50 Hz and/or 60 Hz – see individual article for operating frequency
Limits operation voltage electronic		50 – 456V AC
Limits operation voltage test circuit		
30 mA		196 - 264V AC
30 mA -400		353 - 456V AC
300 mA		196 - 456V AC
Rated tripping current	$I_{\Delta n}$	30, 300 mA
Sensitivity		All types of current
Rated insulation voltage	U_i	440 V
Rated impulse withstand voltage	U_{imp}	4 kV (1.2/50 μ s)
Rated short circuit capacity	I_{cn}	10 kA with back-up fuse
Peak withstand current		
Type G/B, G/B+ and G/Bfq		3 kA (8/20 μ s) surge current-proof
Type S/B, S/B+ and S/Bfq		5 kA (8/20 μ s) selective + surge current-proof
Rated breaking capacity or rated fault breaking capacity	I_m $I_{\Delta m}$	
$I_n = 25-40$ A		500 A
$I_n = 63$ A		630 A
Endurance		
electrical components		$\geq 4,000$ operating cycles
mechanical components		$\geq 20,000$ operating cycles
Mechanical		
Frame size		45 mm
Device height		80 mm
Device width		70 mm (4MU)
Mounting		quick fastening with 2 lock-in positions on DIN rail IEC/EN 60715
Degree of protection, built-in		IP40
Degree of protection in moisture-proof enclosure		IP54
Upper and lower terminals		open mouthed/lift terminals
Terminal protection		finger and hand touch safe, DGUV VS3, EN 50274
Terminal capacity		1.5 - 35 mm ² single wire 2 x 16 mm ² multi wire
Terminal screw		M5 (with slotted screw acc. to EN ISO 4757-Z2, Pozidriv PZ2)
Terminal torque		2 - 2.4 Nm
Busbar thickness		0.8 - 2 mm
Operation temperature		-25°C to +40°C (for higher values see table on ambient temperature)
Storage- and transport temperature		-35°C to +60°C
Resistance to climatic conditions		25-55°C/90-95% relative humidity acc. to IEC 60068-2
Contact position indicator		red / green
Tripping indicator		white / blue
Internal contact		
Rated breaking capacity @ 30 V DC (resistive load)		2 A
Rated breaking capacity @ 240 V AC (resistive load)		0.25 A
Maximum switching power (resistive load)		60 W
Maximum switching voltage DC		220 V
Maximum switching voltage AC		240 V
Maximum switching current		2 A
Minimum switching capacity (reference value)		10 μ A, 10 mV DC
Endurance		
Electrical (at 20 cpm) 2 A 30 V DC resistive load)		$>10^5$
Electrical (at 20 cpm) 1 A 30 V DC resistive load)		$>5 \times 10^5$
Terminal capacity		0.25 - 1.5 mm ²

Connection diagram

4-poles (2-Pole)

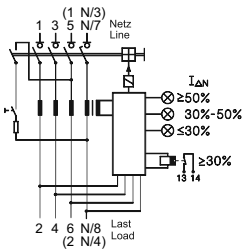

① Basic diagram

4-poles (30mA-400 Types)

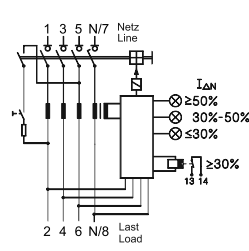

① Basic diagram

4-poles (2-Pole)

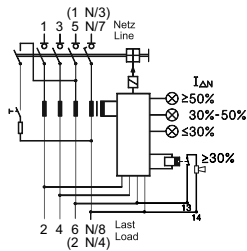

② Signalisation without Isolation Transformer 1:1 (IEC/EN 60664)

4-poles (2-Pole)

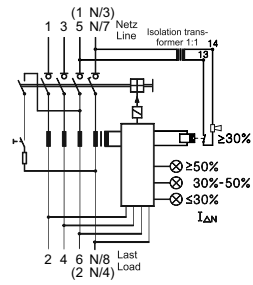

③ Signalisation with Isolation Transformer 1:1 (IEC/EN 60664)

Dimensions (mm)

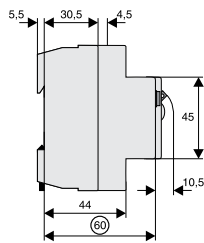
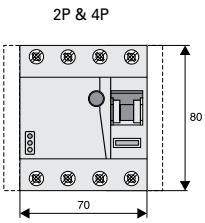

Correct connection

2-pole

30, 300mA Types:

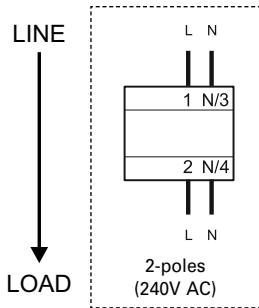

4-pole

30mA -400 Types:

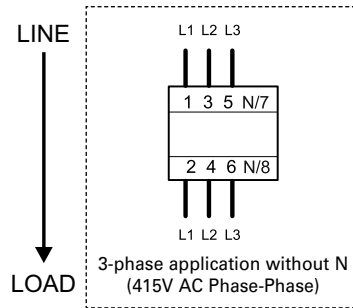

4-pole

30mA Types:

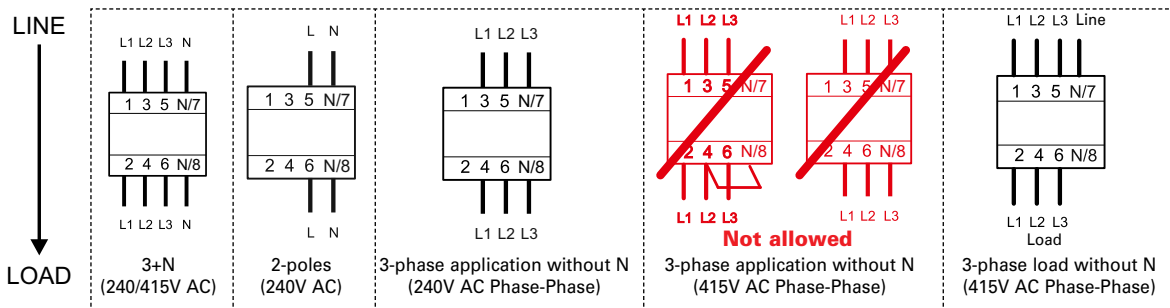

300mA Types:

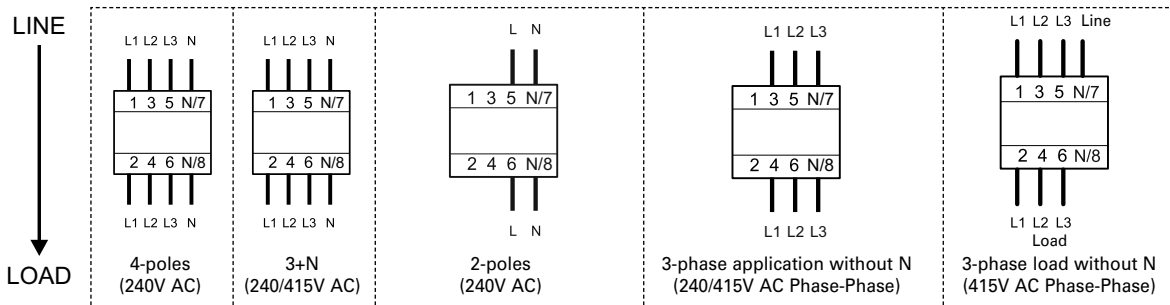

- Disconnect load side of the switch gear, if you make a insulation test of the installation!
- Please take care of supply side and load side!

Tripping current frequency response FRCdM Type B, Bfq and B+

Type B 30mA

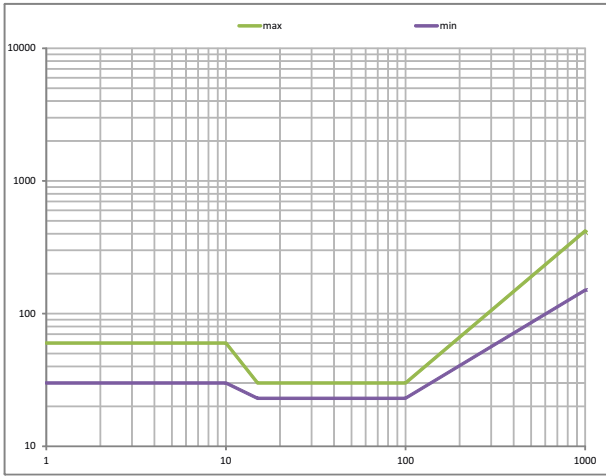

Type B 300mA

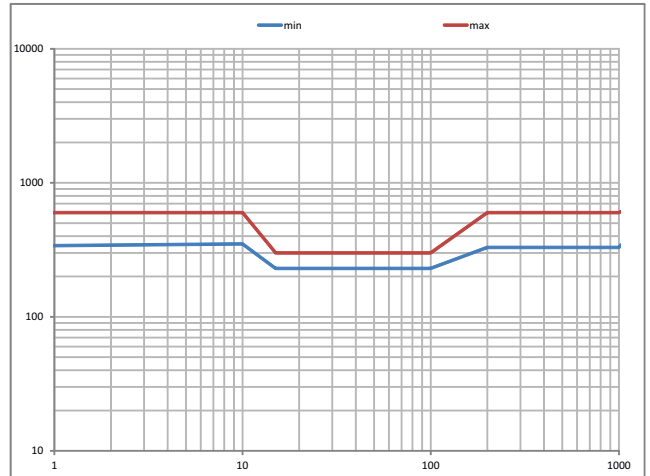

Type B+ 30mA

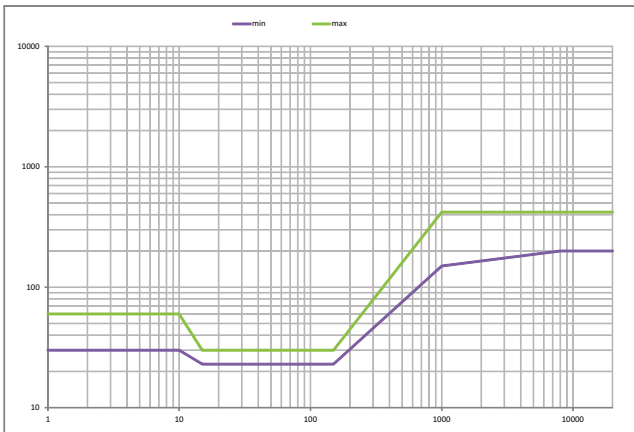

Type B+ 300mA

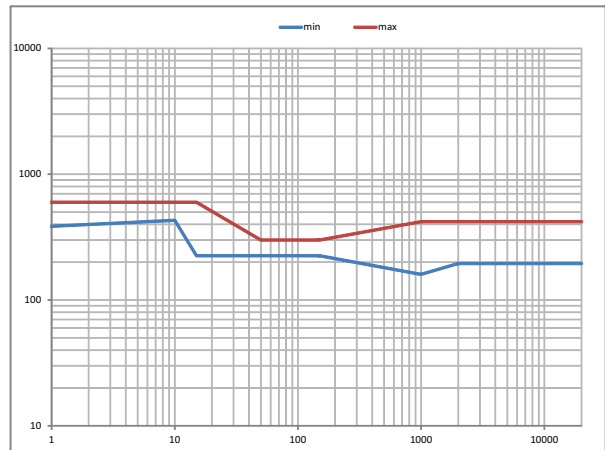

Type Bfq 30mA

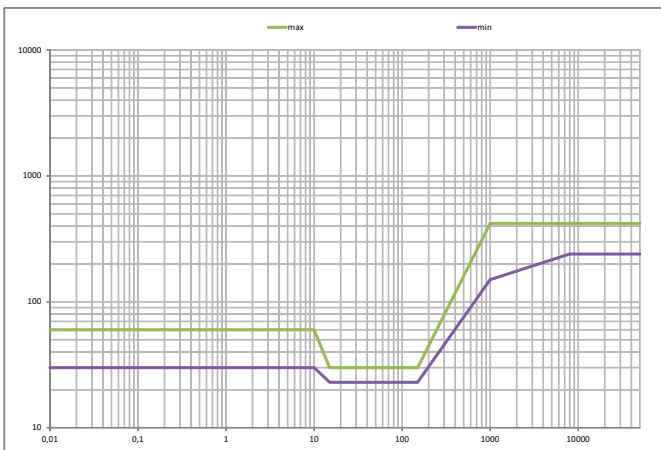

Type Bfq 300mA

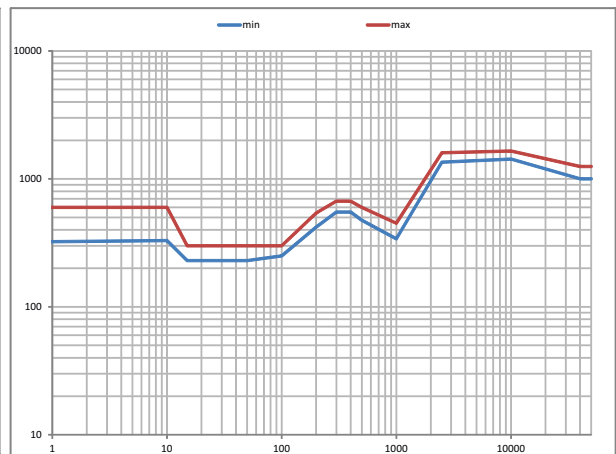

Power Loss at I_n FRCdM

(entire unit)

In [A]	P* [W]	
	2p	4p
25	3.1	4.6
40	4.1	6.2
63	6.7	10

* 50Hz

Impact of ambient temperature on the maximum permanent current allowed (A) FRCdM Type B, Bfq and B+

Ambient temperature	25A	40A	63A
	2p & 4p	2p & 4p	2p & 4p
40°	25	40	63
45°	25	40	56
50°	25	40	50
55°	25	35	45
60°	25	30	40
65°	-	-	-
70°	-	-	-
75°	-	-	-

Note: Please make sure that these values are not exceeded and that any upstream thermal overload protection switches off in time.

Max. back-up fuse FRCdM Type B

Rating In [A]	Fuses		MCB's (Characteristic B/C)	
	Short Circuit [A]	Overload [A]	Short Circuit [A]	Overload [A]
25	63 gG/gI	25 gG/gI	FAZ-C40	FAZ-C25
40	63 gG/gI	40 gG/gI	FAZ-C40	FAZ-C40
63	63 gG/gI	63 gG/gI	FAZ-C40	FAZ-C40

Important:

In the case that the maximal possible operating current of the electrical installation don't exceed the rated current of the RCD only short circuit protection must be implemented. Overload protection must be implemented in the case if the maximal possible operating current of the electrical installation can exceed the rated current of the RCD.

SG02613



Description

- Line voltage independent RCCB for fault protection, additional protection as well as fire protection
- Complete range of RCCBs available to fulfil all application needs
- Fault current tripping indicator enables to determine the tripping reason
- Comprehensive accessories available
- Suitable to be put into rail rolling stock applications due to additional certification

$I_n/I_{\Delta n}$ (A)	Operating frequency (Hz)	Type Designation	Article No.	Units per package
---------------------------	-----------------------------	---------------------	-------------	----------------------

Type AC

Conditionally surge current-proof 250 A, Type AC 

SG02713



2-poles

16/0.03	50	FRCmM-16/2/003	170390	1/60
16/0.1	50	FRCmM-16/2/01	170396	1/60
16/0.3	50	FRCmM-16/2/03	170402	1/60
16/0.5	50	FRCmM-16/2/05	170405	1/60
25/0.03	50	FRCmM-25/2/003	170391	1/60
25/0.1	50	FRCmM-25/2/01	170397	1/60
25/0.3	50	FRCmM-25/2/03	170403	1/60
25/0.5	50	FRCmM-25/2/05	170406	1/60
40/0.03	50	FRCmM-40/2/003	170392	1/60
40/0.1	50	FRCmM-40/2/01	170398	1/60
40/0.3	50	FRCmM-40/2/03	170404	1/60
40/0.5	50	FRCmM-40/2/05	170407	1/60
63/0.03	50	FRCmM-63/2/003	170393	1/60
63/0.1	50	FRCmM-63/2/01	170399	1/60
63/0.5	50	FRCmM-63/2/05	170408	1/60
80/0.03	50	FRCmM-80/2/003	170394	1/60
80/0.1	50	FRCmM-80/2/01	170400	1/60
80/0.3	50	FRCMM-80/2/03	180778	1/60
80/0.5	50	FRCMM-80/2/05	180779	1/60
100/0.03	50	FRCmM-100/2/003	170395	1/60
100/0.1	50	FRCmM-100/2/01	170401	1/60
100/0.3	50	FRCMM-100/2/03	180781	1/60

SG02613



4-poles

16/0.03	50	FRCmM-16/4/003	170409	1/30
16/0.1	50	FRCmM-16/4/01	170415	1/30
16/0.3	50	FRCmM-16/4/03	170418	1/30
16/0.5	50	FRCmM-16/4/05	170424	1/30
25/0.03	50	FRCmM-25/4/003	170410	1/30
25/0.1	50	FRCmM-25/4/01	170416	1/30
25/0.3	50	FRCmM-25/4/03	170419	1/30
25/0.5	50	FRCmM-25/4/05	170425	1/30
40/0.03	50	FRCmM-40/4/003	170411	1/30
40/0.1	50	FRCmM-40/4/01	170417	1/30
40/0.3	50	FRCmM-40/4/03	170420	1/30
40/0.5	50	FRCmM-40/4/05	170426	1/30
63/0.03	50	FRCmM-63/4/003	170412	1/30
63/0.1	50	FRCMM-63/4/01	180777	1/30
63/0.3	50	FRCmM-63/4/03	170421	1/30
63/0.5	50	FRCmM-63/4/05	170427	1/30
80/0.03	50	FRCmM-80/4/003	170413	1/30
80/0.1	50	FRCMM-80/4/01	180780	1/30
80/0.3	50	FRCmM-80/4/03	170422	1/30
80/0.5	50	FRCmM-80/4/05	170428	1/30
100/0.03	50	FRCmM-100/4/003	170414	1/30
100/0.1	50	FRCMM-100/4/01	180782	1/30
100/0.3	50	FRCmM-100/4/03	170423	1/30
100/0.5	50	FRCmM-100/4/05	170429	1/30

$I_n/I_{\Delta n}$ (A)	Operating frequency (Hz)	Type Designation	Article No.	Units per package
---------------------------	-----------------------------	---------------------	-------------	----------------------

Type A

Conditionally surge current-proof 250 A, sensitive to residual pulsating DC, Type A

SG02713



2-poles

16/0.03	50/60	FRCmM-16/2/003-A	170430	1/60
16/0.1	50/60	FRCmM-16/2/01-A	170436	1/60
16/0.3	50/60	FRCmM-16/2/03-A	170278	1/60
16/0.5	50	FRCmM-16/2/05-A	170281	1/60
25/0.03	50/60	FRCmM-25/2/003-A	170431	1/60
25/0.1	50/60	FRCmM-25/2/01-A	170437	1/60
25/0.3	50/60	FRCmM-25/2/03-A	170279	1/60
25/0.5	50	FRCmM-25/2/05-A	170282	1/60
40/0.03	50/60	FRCmM-40/2/003-A	170432	1/60
40/0.1	50/60	FRCmM-40/2/01-A	170274	1/60
40/0.3	50/60	FRCmM-40/2/03-A	170280	1/60
40/0.5	50	FRCmM-40/2/05-A	170283	1/60
63/0.03	50/60	FRCmM-63/2/003-A	170433	1/60
63/0.1	50/60	FRCmM-63/2/01-A	170275	1/60
63/0.3	50/60	FRCmM-63/2/03-A	304063	1/60
63/0.5	50	FRCmM-63/2/05-A	170284	1/60
80/0.03	50/60	FRCmM-80/2/003-A	170434	1/60
80/0.1	50/60	FRCmM-80/2/01-A	170276	1/60
80/0.3	50/60	FRCmM-80/2/03-A	304064	1/60
100/0.03	50/60	FRCmM-100/2/003-A	170435	1/60
100/0.1	50/60	FRCmM-100/2/01-A	170277	1/60
100/0.3	50/60	FRCmM-100/2/03-A	304065	1/60

SG02613



4-poles

16/0.03	50/60	FRCmM-16/4/003-A	170285	1/30
16/0.03	50/60	FRCmM-16/4/003-A-400	304101	1/30
16/0.1	50/60	FRCmM-16/4/01-A	170337	1/30
16/0.3	50/60	FRCmM-16/4/03-A	170340	1/30
16/0.5	50	FRCmM-16/4/05-A	170346	1/30
25/0.03	50/60	FRCmM-25/4/003-A	170332	1/30
25/0.03	50/60	FRCmM-25/4/003-A-400	304102	1/30
25/0.1	50/60	FRCmM-25/4/01-A	170338	1/30
25/0.3	50/60	FRCmM-25/4/03-A	170341	1/30
25/0.5	50	FRCmM-25/4/05-A	170347	1/30
40/0.03	50/60	FRCmM-40/4/003-A	170333	1/30
40/0.03	50/60	FRCmM-40/4/003-A-400	304116	1/30
40/0.1	50/60	FRCmM-40/4/01-A	170339	1/30
40/0.3	50/60	FRCmM-40/4/03-A	170342	1/30
40/0.5	50	FRCmM-40/4/05-A	170348	1/30
63/0.03	50/60	FRCmM-63/4/003-A	170334	1/30
63/0.03	50/60	FRCmM-63/4/003-A-400	304167	1/30
63/0.3	50/60	FRCmM-63/4/03-A	170343	1/30
63/0.5	50	FRCmM-63/4/05-A	170349	1/30
80/0.03	50/60	FRCmM-80/4/003-A	170335	1/30
80/0.03	50/60	FRCmM-80/4/003-A-400	304186	1/30
80/0.3	50/60	FRCmM-80/4/03-A	170344	1/30
80/0.5	50	FRCmM-80/4/05-A	170350	1/30
100/0.03	50/60	FRCmM-100/4/003-A	170336	1/30
100/0.03	50/60	FRCmM-100/4/003-A-400	304194	1/30
100/0.3	50/60	FRCmM-100/4/03-A	170345	1/30
100/0.5	50	FRCmM-100/4/05-A	170351	1/30

$I_n/I_{\Delta n}$ (A)	Operating frequency (Hz)	Type Designation	Article No.	Units per package
---------------------------	-----------------------------	---------------------	-------------	----------------------

Type G

Surge current-proof 3 kA, Type G (ÖVE E 8601) 

SG02713



2-poles

16/0.03	50/60	FRCmM-16/2/003-G	170352	1/60
16/0.1	50/60	FRCmM-16/2/01-G	170358	1/60
16/0.3	50/60	FRCmM-16/2/03-G	170364	1/60
25/0.03	50/60	FRCmM-25/2/003-G	170353	1/60
25/0.1	50/60	FRCmM-25/2/01-G	170359	1/60
25/0.3	50/60	FRCmM-25/2/03-G	170365	1/60
40/0.03	50/60	FRCmM-40/2/003-G	170354	1/60
40/0.1	50/60	FRCmM-40/2/01-G	170360	1/60
40/0.3	50/60	FRCmM-40/2/03-G	170366	1/60
63/0.03	50/60	FRCmM-63/2/003-G	170355	1/60
63/0.1	50/60	FRCmM-63/2/01-G	170361	1/60
80/0.03	50/60	FRCmM-80/2/003-G	170356	1/60
80/0.1	50/60	FRCmM-80/2/01-G	170362	1/60
100/0.03	50/60	FRCmM-100/2/003-G	170357	1/60
100/0.1	50/60	FRCmM-100/2/01-G	170363	1/60

SG02613



4-poles

16/0.03	50/60	FRCmM-16/4/003-G	170367	1/30
16/0.1	50/60	FRCmM-16/4/01-G	170373	1/30
16/0.3	50/60	FRCmM-16/4/03-G	170376	1/30
25/0.03	50/60	FRCmM-25/4/003-G	170368	1/30
25/0.1	50/60	FRCmM-25/4/01-G	170374	1/30
25/0.3	50/60	FRCmM-25/4/03-G	170377	1/30
40/0.03	50/60	FRCmM-40/4/003-G	170369	1/30
40/0.1	50/60	FRCmM-40/4/01-G	170375	1/30
40/0.3	50/60	FRCmM-40/4/03-G	170378	1/30
63/0.03	50/60	FRCmM-63/4/003-G	170370	1/30
63/0.3	50/60	FRCmM-63/4/03-G	170379	1/30
80/0.03	50/60	FRCmM-80/4/003-G	170371	1/30
80/0.3	50/60	FRCmM-80/4/03-G	170380	1/30
100/0.03	50/60	FRCmM-100/4/003-G	170372	1/30
100/0.3	50/60	FRCmM-100/4/03-G	170381	1/30

$I_n/I_{\Delta n}$ (A)	Operating frequency (Hz)	Type Designation	Article No.	Units per package
---------------------------	-----------------------------	---------------------	-------------	----------------------

Type G/A**Surge current-proof 3 kA, sensitive to residual pulsating DC, Type G/A (ÖVE E 8601)** 

SG02713

**2-poles**

16/0.03	50/60	FRCmM-16/2/003-G/A	170382	1/60
16/0.1	50/60	FRCmM-16/2/01-G/A	170388	1/60
16/0.3	50/60	FRCmM-16/2/03-G/A	170290	1/60
25/0.03	50/60	FRCmM-25/2/003-G/A	170383	1/60
25/0.1	50/60	FRCmM-25/2/01-G/A	170389	1/60
25/0.3	50/60	FRCmM-25/2/03-G/A	170291	1/60
40/0.03	50/60	FRCmM-40/2/003-G/A	170384	1/60
40/0.1	50/60	FRCmM-40/2/01-G/A	170286	1/60
40/0.3	50/60	FRCmM-40/2/03-G/A	170292	1/60
63/0.03	50/60	FRCmM-63/2/003-G/A	170385	1/60
63/0.1	50/60	FRCmM-63/2/01-G/A	170287	1/60
80/0.03	50/60	FRCmM-80/2/003-G/A	170386	1/60
80/0.1	50/60	FRCmM-80/2/01-G/A	170288	1/60
100/0.03	50/60	FRCmM-100/2/003-G/A	170387	1/60
100/0.1	50/60	FRCmM-100/2/01-G/A	170289	1/60

SG02613

**4-poles**

16/0.03	50/60	FRCmM-16/4/003-G/A	170293	1/30
16/0.1	50/60	FRCmM-16/4/01-G/A	170299	1/30
16/0.3	50/60	FRCmM-16/4/03-G/A	170302	1/30
25/0.03	50/60	FRCmM-25/4/003-G/A	170294	1/30
25/0.1	50/60	FRCmM-25/4/01-G/A	170300	1/30
25/0.3	50/60	FRCmM-25/4/03-G/A	170303	1/30
40/0.03	50/60	FRCmM-40/4/003-G/A	170295	1/30
40/0.1	50/60	FRCmM-40/4/01-G/A	170301	1/30
40/0.3	50/60	FRCmM-40/4/03-G/A	170304	1/30
63/0.03	50/60	FRCmM-63/4/003-G/A	170296	1/30
63/0.3	50/60	FRCmM-63/4/03-G/A	170305	1/30
80/0.03	50/60	FRCmM-80/4/003-G/A	170297	1/30
80/0.3	50/60	FRCmM-80/4/03-G/A	170306	1/30
100/0.03	50/60	FRCmM-100/4/003-G/A	170298	1/30
100/0.3	50/60	FRCmM-100/4/03-G/A	170307	1/30

$I_n/I_{\Delta n}$ (A)	Operating frequency (Hz)	Type Designation	Article No.	Units per package
---------------------------	-----------------------------	---------------------	-------------	----------------------

Type S

Selective + surge current-proof 5 kA, Type S 

SG02713



2-poles

16/0.1	50/60	FRCmM-16/2/01-S	170314	1/60
25/0.1	50/60	FRCmM-25/2/01-S	170315	1/60
40/0.1	50/60	FRCmM-40/2/01-S	170316	1/60
40/03	50/60	FRCMM-40/2/03-S	180776	1/60
63/0.1	50/60	FRCmM-63/2/01-S	170317	1/60
80/0.1	50/60	FRCmM-80/2/01-S	170318	1/60
100/0.1	50/60	FRCmM-100/2/01-S	170319	1/60

SG02613



4-poles

16/0.1	50/60	FRCmM-16/4/01-S	170320	1/30
16/0.3	50/60	FRCmM-16/4/03-S	170324	1/30
25/0.1	50/60	FRCmM-25/4/01-S	170321	1/30
25/0.3	50/60	FRCmM-25/4/03-S	170325	1/30
40/0.1	50/60	FRCmM-40/4/01-S	170322	1/30
40/0.3	50/60	FRCmM-40/4/03-S	170326	1/30
63/0.1	50/60	FRCmM-63/4/01-S	170323	1/30
63/0.3	50/60	FRCmM-63/4/03-S	170327	1/30
80/0.3	50/60	FRCmM-80/4/03-S	170328	1/30
100/0.3	50/60	FRCmM-100/4/03-S	170329	1/30

Type S/A

Selective + surge current-proof 5 kA, sensitive to residual pulsating DC, Type S/A 

SG02713



2-poles

16/0.1	50/60	FRCmM-16/2/01-S/A	170330	1/60
25/0.1	50/60	FRCmM-25/2/01-S/A	170331	1/60
40/0.1	50/60	FRCmM-40/2/01-S/A	170438	1/60
63/0.1	50/60	FRCmM-63/2/01-S/A	170439	1/60
63/03	50/60	FRCMM-63/2/03-S/A	180636	1/60
80/0.1	50/60	FRCmM-80/2/01-S/A	170440	1/60
100/0.1	50/60	FRCmM-100/2/01-S/A	170441	1/60

SG02613





4-poles

16/0.1	50/60	FRCmM-16/4/01-S/A	170442	1/30
16/0.3	50/60	FRCmM-16/4/03-S/A	170446	1/30
25/0.1	50/60	FRCmM-25/4/01-S/A	170443	1/30
25/0.3	50/60	FRCmM-25/4/03-S/A	170447	1/30
40/0.1	50/60	FRCmM-40/4/01-S/A	170444	1/30
40/0.3	50/60	FRCmM-40/4/03-S/A	170448	1/30
63/0.1	50/60	FRCmM-63/4/01-S/A	170445	1/30
63/0.3	50/60	FRCmM-63/4/03-S/A	170449	1/30
80/0.3	50/60	FRCmM-80/4/03-S/A	170450	1/30
100/0.3	50/60	FRCmM-100/4/03-S/A	170451	1/30

$I_n/I_{\Delta n}$ (A)	Operating frequency (Hz)	Type Designation	Article No.	Units per package
---------------------------	-----------------------------	---------------------	-------------	----------------------

Type G/F

Surge current-proof 3 kA, sensitive to residual pulsating DC, Type G/F (ÖVE E 8601)  

sg01516



2-poles

16/0.03	50/60	FRCMM-16/2/003-G/F	187365	1/60
16/0.1	50/60	FRCMM-16/2/01-G/F	187371	1/60
16/0.3	50/60	FRCMM-16/2/03-G/F	187377	1/60
25/0.03	50/60	FRCMM-25/2/003-G/F	187366	1/60
25/0.1	50/60	FRCMM-25/2/01-G/F	187372	1/60
25/0.3	50/60	FRCMM-25/2/03-G/F	187378	1/60
40/0.03	50/60	FRCMM-40/2/003-G/F	187367	1/60
40/0.1	50/60	FRCMM-40/2/01-G/F	187373	1/60
40/0.3	50/60	FRCMM-40/2/03-G/F	187379	1/60
63/0.03	50/60	FRCMM-63/2/003-G/F	187368	1/60
63/0.1	50/60	FRCMM-63/2/01-G/F	187374	1/60
63/0.3	50/60	FRCMM-63/2/03-G/F	187380	1/60
80/0.03	50/60	FRCMM-80/2/003-G/F	187369	1/60
80/0.1	50/60	FRCMM-80/2/01-G/F	187375	1/60
80/0.3	50/60	FRCMM-80/2/03-G/F	187381	1/60
100/0.03	50/60	FRCMM-100/2/003-G/F	187370	1/60
100/0.1	50/60	FRCMM-100/2/01-G/F	187376	1/60
100/0.3	50/60	FRCMM-100/2/03-G/F	187382	1/60

sg01616





4-poles

16/0.03	50/60	FRCMM-16/4/003-G/F	187407	1/30
16/0.1	50/60	FRCMM-16/4/01-G/F	187413	1/30
16/0.3	50/60	FRCMM-16/4/03-G/F	187419	1/30
25/0.03	50/60	FRCMM-25/4/003-G/F	187408	1/30
25/0.1	50/60	FRCMM-25/4/01-G/F	187414	1/30
25/0.3	50/60	FRCMM-25/4/03-G/F	187420	1/30
40/0.03	50/60	FRCMM-40/4/003-G/F	187409	1/30
40/0.1	50/60	FRCMM-40/4/01-G/F	187415	1/30
40/0.3	50/60	FRCMM-40/4/03-G/F	187421	1/30
63/0.03	50/60	FRCMM-63/4/003-G/F	187410	1/30
63/0.1	50/60	FRCMM-63/4/01-G/F	187416	1/30
63/0.3	50/60	FRCMM-63/4/03-G/F	187422	1/30
80/0.03	50/60	FRCMM-80/4/003-G/F	187411	1/30
80/0.1	50/60	FRCMM-80/4/01-G/F	187417	1/30
80/0.3	50/60	FRCMM-80/4/03-G/F	187423	1/30
100/0.03	50/60	FRCMM-100/4/003-G/F	187412	1/30
100/0.1	50/60	FRCMM-100/4/01-G/F	187418	1/30
100/0.3	50/60	FRCMM-100/4/03-G/F	187424	1/30

$I_n/I_{\Delta n}$ (A)	Operating frequency (Hz)	Type Designation	Article No.	Units per package
---------------------------	-----------------------------	---------------------	-------------	----------------------

Type S/F

Selective + surge current-proof 5 kA, sensitive to residual pulsating DC, Type S/F  

sg01516



2-poles

16/0.1	50/60	FRCMM-16/2/01-S/F	187389	1/60
16/0.3	50/60	FRCMM-16/2/03-S/F	187395	1/60
25/0.1	50/60	FRCMM-25/2/01-S/F	187390	1/60
25/0.3	50/60	FRCMM-25/2/03-S/F	187396	1/60
40/0.1	50/60	FRCMM-40/2/01-S/F	187391	1/60
40/0.3	50/60	FRCMM-40/2/03-S/F	187397	1/60
63/0.1	50/60	FRCMM-63/2/01-S/F	187392	1/60
63/0.3	50/60	FRCMM-63/2/03-S/F	187398	1/60
80/0.1	50/60	FRCMM-80/2/01-S/F	187393	1/60
80/0.3	50/60	FRCMM-80/2/03-S/F	187399	1/60
100/0.1	50/60	FRCMM-100/2/01-S/F	187394	1/60
100/0.3	50/60	FRCMM-100/2/03-S/F	187400	1/60

sg01616



4-poles

16/0.1	50/60	FRCMM-16/4/01-S/F	187431	1/30
16/0.3	50/60	FRCMM-16/4/03-S/F	187437	1/30
25/0.1	50/60	FRCMM-25/4/01-S/F	187432	1/30
25/0.3	50/60	FRCMM-25/4/03-S/F	187438	1/30
40/0.1	50/60	FRCMM-40/4/01-S/F	187433	1/30
40/0.3	50/60	FRCMM-40/4/03-S/F	187439	1/30
63/0.1	50/60	FRCMM-63/4/01-S/F	187434	1/30
63/0.3	50/60	FRCMM-63/4/03-S/F	187440	1/30
80/0.1	50/60	FRCMM-80/4/01-S/F	187435	1/30
80/0.3	50/60	FRCMM-80/4/03-S/F	187441	1/30
100/0.1	50/60	FRCMM-100/4/01-S/F	187436	1/30
100/0.3	50/60	FRCMM-100/4/03-S/F	187442	1/30

SG02613



Description

- Line voltage independent RCCB for fault protection, additional protection as well as fire protection
- Complete range of RCCBs available to fulfill all application needs
- Special design to allow ring tongues to be fitted easily (terminal screws are removable)
- Fault current tripping indicator enables to determine the tripping reason
- Comprehensive accessories available
- Suitable to be put into rail rolling stock applications due to additional certification

$I_n/\Delta n$ (A)	Operating frequency (Hz)	Type Designation	Article No.	Units per package
-----------------------	-----------------------------	---------------------	-------------	----------------------

Type A

Conditionally surge current-proof 250 A, sensitive to residual pulsating DC, Type A

SG02613



2-poles

16/0.03	50/60	FRCmM-16/2/003-A-RT	305061	1/30
16/0.3	50/60	FRCmM-16/2/03-A-RT	305067	1/30
25/0.03	50/60	FRCmM-25/2/003-A-RT	305062	1/30
25/0.3	50/60	FRCmM-25/2/03-A-RT	305068	1/30
40/0.03	50/60	FRCmM-40/2/003-A-RT	305063	1/30
40/0.3	50/60	FRCmM-40/2/03-A-RT	305069	1/30
63/0.03	50/60	FRCmM-63/2/003-A-RT	305064	1/30
63/0.3	50/60	FRCmM-63/2/03-A-RT	305070	1/30

SG02613



4-poles

16/0.03	50/60	FRCMM-16/4/003-A-RT	305081	1/30
16/0.3	50/60	FRCMM-16/4/03-A-RT	305088	1/30
25/0.03	50/60	FRCMM-25/4/003-A-RT	305082	1/30
25/0.3	50/60	FRCMM-25/4/03-A-RT	305090	1/30
40/0.03	50/60	FRCMM-40/4/003-A-RT	305083	1/30
40/0.3	50/60	FRCMM-40/4/03-A-RT	305101	1/30
63/0.03	50/60	FRCMM-63/4/003-A-RT	305084	1/30
63/0.3	50/60	FRCMM-63/4/03-A-RT	305102	1/30

Type S

Selective + surge current-proof 5 kA, Type S

SG02613



2-poles

16/0.3	50/60	FRCMM-16/2/03-S/A-RT	305071	1/30
25/0.3	50/60	FRCMM-25/2/03-S/A-RT	305073	1/30
40/0.3	50/60	FRCMM-40/2/03-S/A-RT	305076	1/30
63/0.3	50/60	FRCMM-63/2/03-S/A-RT	305077	1/30

SG02613



4-poles

16/0.3	50/60	FRCMM-16/4/03-S/A-RT	305104	1/30
25/0.3	50/60	FRCMM-25/4/03-S/A-RT	305109	1/30
40/0.3	50/60	FRCMM-40/4/03-S/A-RT	305110	1/30
63/0.3	50/60	FRCMM-63/4/03-S/A-RT	305111	1/30

Specifications | Residual Current Devices FRcmM

Description

Design

- Residual Current Circuit Breakers (RCCBs) for industrial and commercial applications
- Designed and suitable to be put into an xEffect-System
- Twin-purpose terminal (lift/open-mouthed) above and below
- Tripping indicator white - blue
- Additional safety due:
 - possibility to seal the toggle
 - possibility to lock the toggle
- The device functions irrespective of the position of installation

Accessories

- Busbar positioning optionally above or below
- Free terminal space despite installed busbar
- Auxiliary contacts to be mounted onto the device:
 - Universal tripping signal switch, also suitable for FAZ, FRBmM-1N
 - Auxiliary switch Z-HK can be mounted subsequently

Additional information for the application

- Delayed types suitable for being used with standard fluorescent tubes with or without electronical ballast
 - 30 mA-RCCBs: 30 units per phase conductor
 - 100 mA RCCBs: 90 units per phase conductor

Note: Depending on the fluorescent lamp manufacturer, partly more units possible. Symmetrical allocation of the fluorescent lamp ballasts on all phases favorably. Please still consider the technical data provided by the manufacturer of the lamps.

- Tripping is line voltage independent (VI) and therefore suitable for all BA-classes.

The RCD is suitable for fault protection, additional protection, fire protection within the regulations of the applicable wiring regulations (e.g.: IEC/EN 60364)

- The 4-pole device can also be used for 3-pole and 2 pole applications. Please refer to published connection diagrams

Test Button

- The test button "T" must be pressed once every 6 months. The system operator must be informed of this obligation and his responsibility in a way that can be proven.

Under special conditions (e.g.: damply and/or dusty environments, environments with polluting and/or corroding conditions, environments with large temperature fluctuations, installations with a risk of overvoltage due to switching of equipment and/or atmospheric discharges, portable equipment, ...), it's recommended to test in monthly intervals. Regulations according IEC/EN 60364 or wiring regulations still apply.
- The test button "T" tests the function of the RCCB itself. This test does not measure a "suitable" fault loop or if requirements of such are kept. Testing your fault loop (earth rod resistance, continuity of fault loop,...) requires special tests performed separately.

- **Type A:** These types are capable of sensing pulsating residual currents and are not negatively affected by a DC overlay of up to 6mA. These devices (depended on the range) are also available as:
 - G/A short time delayed devices which are surge current proof up to 3kA. These devices enable a reliable and safe installation with increased system availability
 - S/A selective RCCBs with improved surge current capabilities up to 5kA. These devices are selective (conditions apply) to other RCDs and enable special applications and root installations.
- **Type F:** These types are capable of sensing pulsating residual currents, residual currents up to 1kHz and are not negatively affected by a DC overlay of up to 10mA. They also offer improved availability of your system. These devices (depended on the range) are also available as:
 - G/F short time delayed devices which are surge current proof up to 3 kA. These devices enable a reliable and safe installation with increased system availability
 - S/F selective RCCBs with improved surge current capabilities up to 5kA. These devices are selective (conditions apply) to other RCDs and enable special applications and root installations.
- **Type G:** G Types offer a 10ms time delayed tripping curve and surge current proof capabilities up to 3kA and are highly recommended to be used for applications and installations where system availability is an important factor. Since "G" states a tripping curve and not a sensitivity, these devices (dependent on the range) will be found as:
 - AC sensitive devices (-G)
 - A Type RCCBs (-G/A)
 - F Type RCCBs (-G/F)
 - B/Bfq/B+ Type RCCBs (-G/B(fq/+))
- **Type S:** S Types offer a 40ms time delayed tripping curve and surge current proof capabilities up to 5kA and are know as "selective" types. These devices are mainly used in root applications with additional RCDs deployed in series in the system.

Since "S" states a tripping curve and not a sensitivity, these devices (dependent on the range) will be found as:

 - AC sensitive devices (-S)
 - A Type RCCBs (-S/A)
 - F Type RCCBs (-S/F)

Accessories:

Auxiliary contact to be mounted on the left side	Z-HK	248432
Auxiliary contact to be mounted on the right side	Z-NHK	248434
Automatic restarting device	Z-FW/LP	248296
	Z-FW-LPD	265244
Remote control unit	Z-FW-MO	284730
Sets (Device + remote control unit)	Z-FW-LP/MO	290171
	Z-FW-LPD/MO	290172
Δn testing module	Z-FW/003	248298
	Z-FW/010	248299
	Z-FW/030	248300
Terminal cover 4-poles	Z-RC/AK-4TE	101062

Technical Data

		FRCmM
Electrical		
Design according to		IEC/EN 61008, IEC/EN 62423 for Type F only Type G acc. to ÖVE E 8601
Classified according to		IEC 61373, EN 45545-2
Current test marks as printed onto the device		
Tripping		instantaneous
Type G ,		10 ms delay @ 50 Hz
Type S		40 ms delay @ 50 Hz - with selective disconnecting function
Rated voltage	U_n	240/415 V AC 50 Hz and/or 60 Hz – see individual article for operating frequency
Limits operation voltage test circuit		
2-poles		196 - 264 V~
4-poles 30 mA		196 - 264 V~
4-poles 30 mA -400		353 - 456 V~
4-poles 100, 300, 500 mA		196 - 456 V~
Rated tripping current	$I_{\Delta n}$	30, 100, 300, 500 mA
Sensitivity		> AC, Type A and Type F
Rated insulation voltage	U_i	440 V
Rated impulse withstand voltage	U_{imp}	4 kV (1.2/50µs)
Rated short circuit capacity	I_{cn}	10 kA with back-up fuse
Peak withstand current		
Type AC, A		250 A (8/20 µs) surge current-proof
Type G, G/A, G/F		3 kA (8/20 µs) surge current-proof, 10 ms delay
Type S, S/A, S/F		5 kA (8/20 µs) surge current-proof, 40 ms delay
Rated breaking capacity or rated fault breaking capacity	I_m $I_{\Delta m}$	
$I_n = 16-40$ A		500 A
$I_n = 63$ A		630 A
$I_n = 80$ A		800 A
$I_n = 100$ A		1,000 A
Endurance		
electrical components		≥ 4,000 operating cycles
mechanical components		≥ 20,000 operating cycles
Mechanical		
Frame size		45 mm
Device height		80 mm
Device width		35 mm (2MU), 70 mm (4MU)
Mounting		quick fastening with 2 lock-in positions on DIN rail IEC/EN 60715
Degree of protection, built-in		IP40
Degree of protection in moisture-proof enclosure		IP54
Upper and lower terminals		open mouthed/lift terminals
Terminal protection		finger and hand touch safe, DGUV VS3, EN 50274
Terminal capacity		1.5 - 35 mm ² single wire 2 x 16 mm ² multi wire
Terminal screw		M5 (with slotted screw acc. to EN ISO 4757-Z2, Pozidriv PZ2)
Terminal torque		2 - 2.4 Nm
Busbar thickness		0.8 - 2 mm
Operation temperature		-25°C to +40°C (for higher values see table on ambient temperature)
Storage- and transport temperature		-35°C to +60°C
Resistance to climatic conditions		acc. to IEC/EN 61008
Contact position indicator		red / green
Tripping indicator		white / blue

Connection diagram

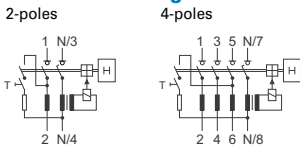

Dimensions (mm)

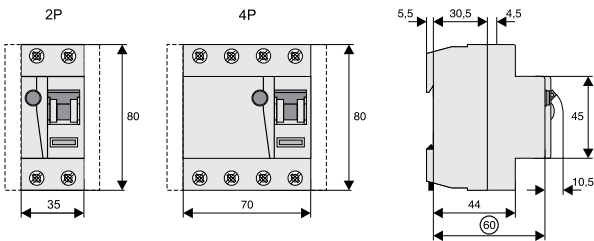

Connection of ring cable lugs (only FRC...RT)

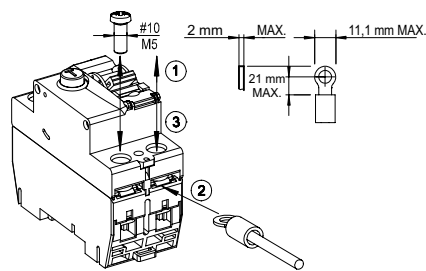

Correct connection

2-poles

30, 100, 300, 500mA Types:

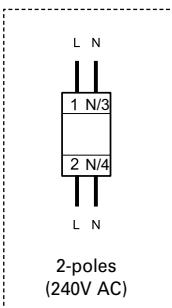

4-poles

30mA -400 Types:

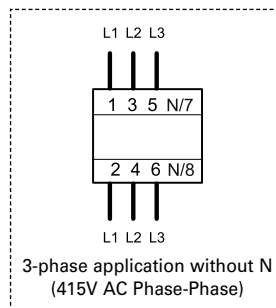

4-poles

30mA Types:

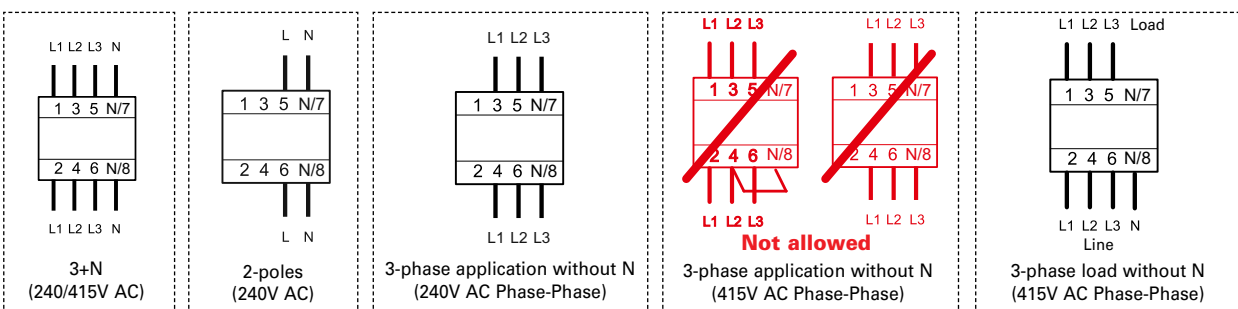

100, 300, 500mA Types:

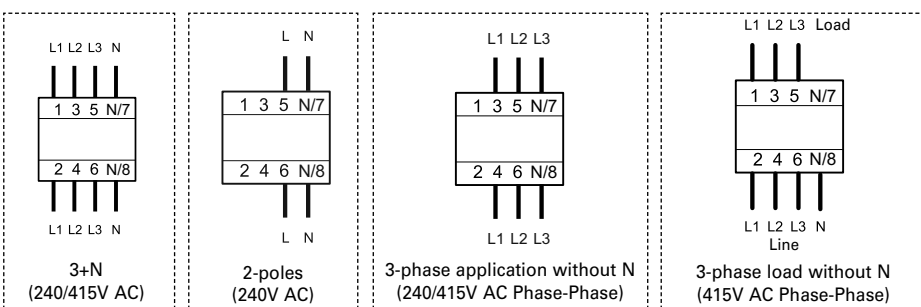

Power Loss at I_n FRCmM

(entire unit)

Tripping: AC

I_n [A]	$I_{\Delta n}$ [mA]	P [W]
2-poles		
16	10	2.9
25	30	2.0
25	100, 300, 500	1.3
40	30	7.8
40	100, 300, 500	5.5
63	30	9.7
63	100, 300, 500	7.2
80	30	13.5
80	100, 300, 500	8.6
100	30, 100, 300	13.6
4-poles		
25	30	3.1
25	100, 300, 500	2.8
40	30	13.1
40	100, 300, 500	8.8
63	30	13.4
63	100, 300, 500	10.5
80	30, 100, 300, 500	11.4
100	30, 100, 300, 500	18.8

Tripping: G, G/A, G/F

I_n [A]	$I_{\Delta n}$ [mA]	P [W]
2-poles		
25	30, 100 (G)	2.0
40	30, 100 (G)	7.8
4-poles		
40	30 (G)	13.1
40	100 (G, G/A)	8.8
40	30 (G/A)	13.1
63	30 (G)	13.4
63	100 (G, G/A)	10.5
63	30 (G/A)	13.4
100	30, 300 (G/A)	18.8

Tripping: A

I_n [A]	$I_{\Delta n}$ [mA]	P [W]
2-poles		
16	10	2.9
16	30	1.2
25	30	2.0
25	100, 300	1.3
40	30	7.8
40	100, 300, 500	5.5
63	30	9.7
63	100, 300, 500	7.2
100	30, 100, 300	13.6
4-poles		
25	30	3.1
25	100, 300, 500	2.8
40	30	13.1
40	100, 300, 500	8.8
63	30, 100, 300, 500	10.5
80	30, 300	11.4
100	30, 100, 300, 500	18.8

Tripping: S, S/A, S/F

I_n [A]	$I_{\Delta n}$ [mA]	P [W]
2-poles		
40	100 (S, S/A)	7.8
40	300 (S)	5.5
4-poles		
25	100, 300 (S)	2.8
25	100 (S/A)	2.8
40	100, 300 (S, S/A)	8.8
63	100, 300 (S)	10.5
63	100, 300 (S/A)	10.5
80	100, 300 (S)	11.4
80	300 (S/A)	11.4
100	300 (S/A)	18.8

Impact of ambient temperature on the maximum permanent current allowed (A) FRCmM

Ambient temperature	25A		40A		63A		80A		100A	
	2p	4p	2p	4p	2p	4p	2p	4p	2p	4p
40°	25	25	40	40	63	63	80	80	100	100
45°	21	22	37	37	59	59	76	76	95	95
50°	18	19	33	34	55	55	72	72	90	90
55°	14	16	30	31	50	50	68	68	85	85
60°	–	–	26	27	45	45	64	64	80	80
65°	–	–	20	24	40	41	60	60	75	75
70°	–	–	14	19	34	37	56	56	70	70
75°	–	–	8	15	28	32	52	52	65	65

Note: Please make sure that these values are not exceeded and that any upstream thermal overload protection switches off in time.

Max. back-up fuse FRCmM

Rating In [A]	Fuses		MCB's (Characteristic B/C)	
	Short Circuit [A]	Overload [A]	Short Circuit [A]	Overload [A]
25	63 gG/gI	25 gG/gI	FAZ-C40	FAZ-C25
40	63 gG/gI	40 gG/gI	FAZ-C40	FAZ-C40
63	63 gG/gI	63 gG/gI	FAZ-C40	FAZ-C40
80	80 gG/gI	80 gG/gI	-	-
100	100 gG/gI	80 gG/gI	-	-

Important:

In the case that the maximal possible operating current of the electrical installation don't exceed the rated current of the RCD only short circuit protection must be implemented. Overload protection must be implemented in the case if the maximal possible operating current of the electrical installation can exceed the rated current of the RCD.

SG02613



Description

- Line voltage independent RCCB for fault protection, additional protection as well as fire protection
- For use in 110V applications
- Complete range of RCCBs available to fulfil all application needs
- Fault current tripping indicator enables to determine the tripping reason
- Comprehensive accessories available
- Suitable to be put into rail rolling stock applications due to additional certification

$I_n/I_{\Delta n}$ (A)	Operating frequency (Hz)	Type Designation	Article No.	Units per package
---------------------------	-----------------------------	---------------------	-------------	----------------------

Type AC

Conditionally surge current-proof 250 A, Type AC

SG02713



2-poles

25/0.03	50	FRCmM-25/2/003-110	180585	1/60
25/0.3	50	FRCmM-25/2/03-110	180586	1/60
40/0.03	50	FRCmM-40/2/003-110	180587	1/60
40/0.3	50	FRCmM-40/2/03-110	180588	1/60
63/0.03	50	FRCmM-63/2/003-110	180589	1/60
63/0.3	50	FRCmM-63/2/03-110	180590	1/60
80/0.03	50	FRCmM-80/2/003-110	180591	1/60
80/0.3	50	FRCmM-80/2/03-110	180592	1/60
100/0.03	50	FRCmM-100/2/003-110	180593	1/60
100/0.3	50	FRCmM-100/2/03-110	180594	1/60

SG02613



4-poles

25/0.03	50	FRCmM-25/4/003-110	180595	1/30
25/0.3	50	FRCmM-25/4/03-110	180596	1/30
40/0.03	50	FRCmM-40/4/003-110	180597	1/30
40/0.3	50	FRCmM-40/4/03-110	180598	1/30
63/0.03	50	FRCmM-63/4/003-110	180599	1/30
63/0.3	50	FRCmM-63/4/03-110	180600	1/30
80/0.03	50	FRCmM-80/4/003-110	180601	1/30
80/0.3	50	FRCmM-80/4/03-110	180602	1/30
100/0.03	50	FRCmM-100/4/003-110	180603	1/30
100/0.3	50	FRCmM-100/4/03-110	180604	1/30

Type A

Conditionally surge current-proof 250 A, sensitive to residual pulsating DC, Type A

SG02713



2-poles

25/0.03	50	FRCmM-25/2/003-A-110	180605	1/60
25/0.3	50	FRCmM-25/2/03-A-110	180606	1/60
40/0.03	50	FRCmM-40/2/003-A-110	180607	1/60
40/0.3	50	FRCmM-40/2/03-A-110	180608	1/60
63/0.03	50	FRCmM-63/2/003-A-110	180609	1/60
80/0.03	50	FRCmM-80/2/003-A-110	180610	1/60
100/0.03	50	FRCmM-100/2/003-A-110	180611	1/60

SG02613



4-poles

25/0.03	50	FRCmM-25/4/003-A-110	180612	1/30
25/0.3	50	FRCmM-25/4/03-A-110	180613	1/30
40/0.03	50	FRCmM-40/4/003-A-110	180614	1/30
40/0.3	50	FRCmM-40/4/03-A-110	180615	1/30
63/0.03	50	FRCmM-63/4/003-A-110	180616	1/30
63/0.3	50	FRCmM-63/4/03-A-110	180617	1/30
80/0.03	50	FRCmM-80/4/003-A-110	180618	1/30
80/0.3	50	FRCmM-80/4/03-A-110	180619	1/30
100/0.03	50	FRCmM-100/4/003-A-110	180620	1/30
100/0.3	50	FRCmM-100/4/03-A-110	180621	1/30

Specifications | Residual Current Devices FRCmM-110

Description

Design

- Residual Current Circuit Breakers (RCCBs) for industrial and commercial applications which operate with 110V
- Designed and suitable to be put into an xEffect-System
- Twin-purpose terminal (lift/open-mouthed) above and below
- Contact position indicator red - green
- Tripping indicator white - blue
- Additional safety due:
 - possibility to seal the toggle
 - possibility to lock the toggle
- The device functions irrespective of the position of installation

- The test button “T” tests the function of the RCCB itself. This test does not measure a “suitable” fault loop or if requirements of such are kept. Testing your fault loop (earth rod resistance, continuity of fault loop,...) requires special tests performed separately.
- **Type A** These types are capable of sensing pulsating residual currents and are not negatively affected by a DC overlay of up to 6 mA.

Accessories

- Busbar positioning optionally above or below
- Free terminal space despite installed busbar
- Auxiliary contacts to be mounted onto the device:
 - Universal tripping signal switch, also suitable for FAZ, FRBmM-11N
 - Auxiliary switch Z-HK can be mounted subsequently

Additional information for the application

- Tripping is line voltage independent (VI) and therefore suitable for all BA-classes.
The RCD is suitable for fault protection, additional protection, fire protection within the regulations of the applicable wiring regulations (e.g.: IEC/EN 60364)
- The 4-pole device can also be used for 3-pole and 2 pole applications. Please refer to published connection diagrams

Test Button

- The test button “T” must be pressed once every 6 months. The system operator must be informed of this obligation and his responsibility in a way that can be proven.
Under special conditions (e.g.: damply and/or dusty environments, environments with polluting and/or corroding conditions, environments with large temperature fluctuations, installations with a risk of overvoltage due to switching of equipment and/or atmospheric discharges, portable equipment, ...), it's recommended to test in monthly intervals. Regulations according IEC/EN 60364 or wiring regulations still apply.

Accessories:

Auxiliary contact to be mounted on the left side	Z-HK	248432
Auxiliary contact to be mounted on the right side	Z-NHK	248434
Automatic restarting device	Z-FW/LP	248296
	Z-FW-LPD	265244
Remote control unit	Z-FW-MO	284730
	Z-FW-LP/MO	290171
Sets (Device + remote control unit)	Z-FW-LPD/MO	290172
	Z-FW/003	248298
IΔn testing module	Z-FW/010	248299
	Z-FW/030	248300
	Z-RC/AK-4TE	101062
Terminal cover 4-poles		

Technical Data

		FRCmM-110
Electrical		
Design according to		IEC/EN 61008
Classified according to		IEC 61373, EN 45545-2
Current test marks as printed onto the device		
Tripping		instantaneous
Rated voltage	U_n	110/190V AC, 50 Hz
Limits operation voltage test circuit		2-poles 94 - 121 V~ 4-poles 30 mA 94 - 121 V~ 4-poles 300 mA 94 - 210 V~
Rated tripping current	$I_{\Delta n}$	30, 300 mA
Sensitivity		AC and pulsating DC
Rated insulation voltage	U_i	440 V
Rated impulse withstand voltage	U_{imp}	4 kV (1.2/50µs)
Rated short circuit capacity	I_{cn}	10 kA with back-up fuse
Peak withstand current		
Type AC, A		250 A (8/20 µs) surge current-proof
Rated breaking capacity	I_m	
or rated fault breaking capacity	$I_{\Delta m}$	
$I_n = 16-40$ A		500 A
$I_n = 63$ A		630 A
$I_n = 80$ A		800 A
$I_n = 100$ A		1,000 A
Endurance		
electrical components		≥ 4,000 operating cycles
mechanical components		≥ 20,000 operating cycles
Mechanical		
Frame size		45 mm
Device height		80 mm
Device width		35 mm (2MU), 70 mm (4MU)
Mounting		quick fastening with 2 lock-in positions on DIN rail IEC/EN 60715
Degree of protection, built-in		IP40
Degree of protection in moisture-proof enclosure		IP54
Upper and lower terminals		open mouthed/lift terminals
Terminal protection		finger and hand touch safe, DGUV VS3, EN 50274
Terminal capacity		1.5 - 35 mm ² single wire 2 x 16 mm ² multi wire
Terminal screw		M5 (with slotted screw acc. to EN ISO 4757-Z2, Pozidriv PZ2)
Terminal torque		2 - 2.4 Nm
Busbar thickness		0.8 - 2 mm
Operation temperature		-25°C to +40°C (for higher values see table on ambient temperature)
Storage- and transport temperature		-35°C to +60°C
Resistance to climatic conditions		acc. to IEC/EN 61008
Contact position indicator		red / green
Tripping indicator		white / blue

Connection diagram

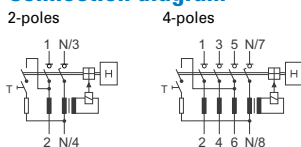

Dimensions (mm)

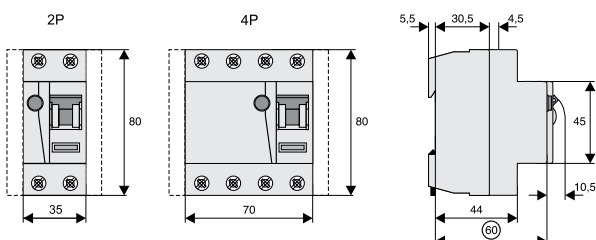

Correct connection

2-poles

30, 300mA Types:

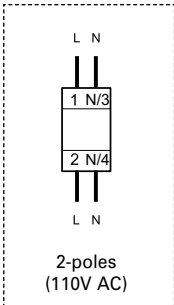

4-poles

30mA Types:

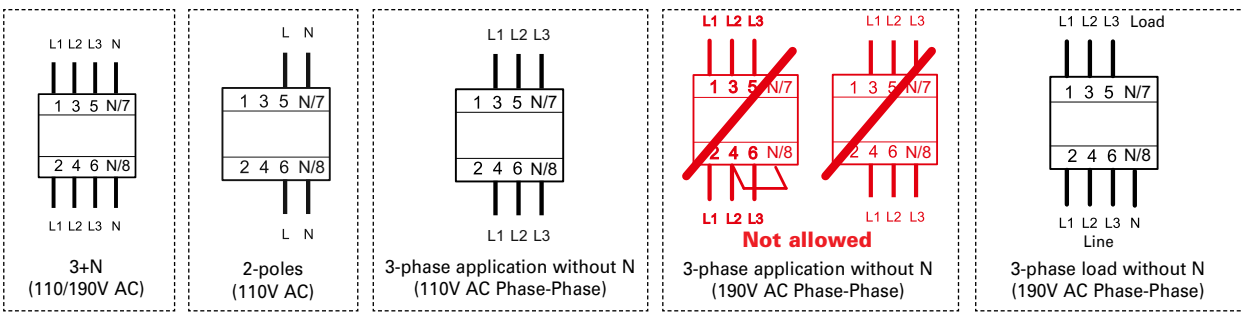

100, 300, 500mA Types:

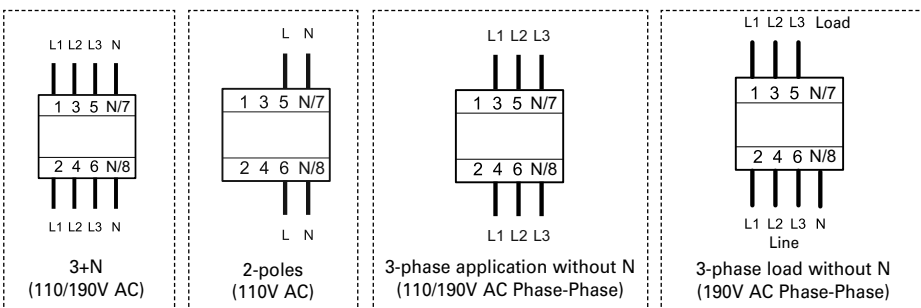

Power Loss at I_n FRCmM-110

(entire unit)

Tripping: AC

I_n [A]	$I_{\Delta n}$ [mA]	P [W]
2-poles		
25	30	2.0
25	100, 300, 500	1.3
40	30	7.8
40	100, 300, 500	5.5
63	30	9.7
63	100, 300, 500	7.2
80	30	13.5
80	100, 300, 500	8.6
100	30, 100, 300	13.6
4-poles		
25	30	3.1
25	100, 300, 500	2.8
40	30	13.1
40	100, 300, 500	8.8
63	30	13.4
63	100, 300, 500	10.5
80	30, 100, 300, 500	11.4
100	30, 100, 300, 500	18.8

Tripping: A

I_n [A]	$I_{\Delta n}$ [mA]	P [W]
2-poles		
16	30	1.2
25	30	2.0
25	100, 300	1.3
40	30	7.8
40	100, 300, 500	5.5
63	30	9.7
63	100, 300, 500	7.2
100	30, 100, 300	13.6
4-poles		
25	30	3.1
25	100, 300, 500	2.8
40	30	13.1
40	100, 300, 500	8.8
63	30, 100, 300, 500	10.5
80	30, 300	11.4
100	30, 100, 300, 500	18.8

SG49612



Description

- Line voltage independent RCCB for fault protection, additional protection as well as fire protection
- Certified according UL 1053 and IEC/EN 61008 to be used in applications worldwide
- Comprehensive range of RCCBs available to fulfil most application needs
- Fault current tripping indicator enables to determine the tripping reason
- Comprehensive accessories available
- Suitable to be put into rail rolling stock applications due to additional certification

$I_n/I_{\Delta n}$ (A)	Operating frequency (Hz)	Type Designation	Article No.	Units per package
---------------------------	-----------------------------	---------------------	-------------	----------------------

Type A

Conditionally surge current-proof 250 A, sensitive to residual pulsating DC, Type A

SG48612



2-poles

25/0.03	50/60	FRCmM-25/2/003-A-NA	167113	1/60
25/0.3	50/60	FRCmM-25/2/03-A-NA	167116	1/60
40/0.03	50/60	FRCmM-40/2/003-A-NA	167114	1/60
40/0.3	50/60	FRCmM-40/2/03-A-NA	167117	1/60
63/0.03	50/60	FRCmM-63/2/003-A-NA	167115	1/60
63/0.3	50/60	FRCmM-63/2/03-A-NA	167118	1/60

SG48612



4-poles

25/0.03	50/60	FRCmM-25/4/003-A-NA	167125	1/30
25/0.3	50/60	FRCmM-25/4/03-A-NA	167104	1/30
40/0.03	50/60	FRCmM-40/4/003-A-NA	167102	1/30
40/0.3	50/60	FRCmM-40/4/03-A-NA	167105	1/30
63/0.03	50/60	FRCmM-63/4/003-A-NA	167103	1/30
63/0.3	50/60	FRCmM-63/4/03-A-NA	167106	1/30

Type G/A

Surge current-proof 3 kA, sensitive to residual pulsating DC, Type G/A (ÖVE E 8601)

SG48612



2-poles

25/0.03	50/60	FRCmM-25/2/003-G/A-NA	167119	1/60
25/0.3	50/60	FRCmM-25/2/03-G/A-NA	167122	1/60
40/0.03	50/60	FRCmM-40/2/003-G/A-NA	167120	1/60
40/0.3	50/60	FRCmM-40/2/03-G/A-NA	167123	1/60
63/0.03	50/60	FRCmM-63/2/003-G/A-NA	167121	1/60
63/0.3	50/60	FRCmM-63/2/03-G/A-NA	167124	1/60

SG48612



4-poles

25/0.03	50/60	FRCmM-25/4/003-G/A-NA	167107	1/30
25/0.3	50/60	FRCmM-25/4/03-G/A-NA	167110	1/30
40/0.03	50/60	FRCmM-40/4/003-G/A-NA	167108	1/30
40/0.3	50/60	FRCmM-40/4/03-G/A-NA	167111	1/30
63/0.03	50/60	FRCmM-63/4/003-G/A-NA	167109	1/30
63/0.3	50/60	FRCmM-63/4/03-G/A-NA	167112	1/30

Specifications | Residual Current Devices FRCmM-NA

Description

Design

- Residual Current Circuit Breakers (RCCBs) for worldwide industrial and commercial applications
- Designed and suitable to be put into an xEffect-System
- Twin-purpose terminal (lift/open-mouthed) above and below
- Contact position indicator red - green
- Tripping indicator white - blue
- Additional safety due:
 - possibility to seal the toggle
 - possibility to lock the toggle
- The device functions irrespective of the position of installation

Accessories

- Busbar positioning optionally above or below
- Free terminal space despite installed busbar
- Auxiliary contacts to be mounted onto the device:
 - Universal tripping signal switch, also suitable for FAZ, FRBmM-1N
 - Auxiliary switch Z-HK can be mounted subsequently

Additional information for the application

- Delayed types suitable for being used with standard fluorescent tubes with or without electronical ballast
 - 30 mA-RCCBs: 30 units per phase conductor
 - 100 mA RCCBs: 90 units per phase conductor

Note: Depending on the fluorescent lamp manufacturer, partly more units possible. Symmetrical allocation of the fluorescent lamp ballasts on all phases favorably. Please still consider the technical data provided by the manufacturer of the lamps.
- Tripping is line voltage independent (VI) and therefore suitable for all BA-classes.

The RCD is suitable for fault protection, additional protection, fire protection within the regulations of the applicable wiring regulations (e.g.: IEC/EN 60364)
- The 4-pole device can also be used for 3-pole and 2 pole applications. Please refer to published connection diagrams

Test Button

- The test button "T" must be pressed once every 6 months. The system operator must be informed of this obligation and his responsibility in a way that can be proven.

Under special conditions (e.g.: damply and/or dusty environments, environments with polluting and/or corroding conditions, environments with large temperature fluctuations, installations with a risk of overvoltage due to switching of equipment and/or atmospheric discharges, portable equipment, ...), it's recommended to test in monthly intervals. Regulations according IEC/EN 60364 or wiring regulations still apply.
- The test button "T" tests the function of the RCCB itself. This test does not measure a "suitable" fault loop or if requirements of such are kept. Testing your fault loop (earth rod resistance, continuity of fault loop,...) requires special tests performed separately.
- **Type A** These types are capable of sensing pulsating residual currents and are not negatively affected by a DC overlay of up to 6 mA. These devices are also available as:
 - G/A short time delayed devices which are surge current proof up to 3 kA. These devices enable a reliable and safe installation with increased system availability
- **Type G** G Types offer a 10 ms time delayed tripping curve and surge current proof capabilities up to 3 kA and are highly recommended to be used for applications and installations where system availability is an important factor.

Since "G" states a tripping curve and not a sensitivity, these devices can also be found as:

 - A Type RCCBs (-G/A-NA)

Accessories:

Auxiliary contact to be mounted on the left side *)	Z-HK	248432
Auxiliary contact to be mounted on the right side	Z-NHK	248434
Automatic restarting device *)	Z-FW/LP	248296
	Z-FW-LPD	265244
Remote control unit *)	Z-FW-MO	284730
Sets (Device + remote control unit) *)	Z-FW-LP/MO	290171
	Z-FW-LPD/MO	290172
IΔn testing module *)	Z-FW/003	248298
	Z-FW/010	248299
	Z-FW/030	248300
	Z-RC/AK-4TE	101062
Terminal cover 4-poles *)		

*) without UL certification

Technical Data

		FRCmM-NA
Electrical according to IEC/EN 61008		
Design according to		IEC/EN 61008, ÖVE E 8601
Classified according to		IEC 61373, EN 45545-2
Current test marks as printed onto the device		
Tripping		instantaneous
Type G		10 ms delay at 50 Hz
Rated voltage	U_n	240/415 V; 50/60 Hz
Limits operation voltage test circuit		
2-poles		196 - 264 V~
4-poles 30 mA		196 - 264 V~
4-poles 300 mA		196 - 456 V~
Rated tripping current	$I_{\Delta n}$	30, 300 mA
Sensitivity		AC and pulsating DC
Rated insulation voltage	U_i	440 V
Rated impulse withstand voltage	U_{imp}	4 kV (1.2/50 μ s)
Rated short circuit capacity	I_{cn}	10 kA with back-up fuse
Peak withstand current		
Type A		250 A (8/20 μ s) surge current-proof
Type G/A		3 kA (8/20 μ s) surge current-proof, 10 ms delay
Rated breaking capacity	I_m	
or rated fault breaking capacity	$I_{\Delta m}$	
$I_n = 25-40$ A		500 A
$I_n = 63$ A		630 A
Endurance		
electrical components		$\geq 4,000$ operating cycles
mechanical components		$\geq 10,000$ operating cycles
Electrical according to UL1053		
Design according to		UL1053
Current test marks as printed onto the device		
Tripping		instantaneous
Type G		8 ms delay at 60 Hz
Rated voltage	U_n	480Y/277 V, 60 Hz
Limits operation voltage test circuit		
2-poles		196 - 305 V~
4-poles 30 mA		196 - 305 V~
4-poles 300 mA		196 - 528 V~
Pick-up current		
30 mA Types		22 mA
300 mA Types		200 mA
Sensitivity		AC and pulsating DC
Overvoltage tested		530 V
Rated impulse withstand voltage	U_{imp}	4 kV (1.2/50 μ s)
Rated short circuit capacity	I_{cn}	5 kA acc. to CSA
Rated breaking capacity	I_m	
or rated fault breaking capacity	$I_{\Delta m}$	
$I_n = 25-40$ A		500 A
$I_n = 63$ A		630 A
Endurance		
electrical components		$\geq 4,000$ operating cycles
mechanical components		$\geq 10,000$ operating cycles

Mechanical

Frame size	45 mm
Device height	80 mm
Device width	35 mm (2MU), 70 mm (4MU)
Mounting	quick fastening with 2 lock-in positions on DIN rail IEC/EN 60715
Degree of protection, built-in	IP40
Degree of protection in moisture-proof enclosure	IP54
Upper and lower terminals	lift terminals
Terminal protection	finger and hand touch safe, DGVV VS3, EN 50274
Terminal capacity	1.5 - 35 mm ² single wire 2 x 16 mm ² multi wire
Terminal screw	M5 (with slotted screw acc. to EN ISO 4757-Z2, Pozidriv PZ2)
Operation temperature	-25°C to +40°C
Storage- and transport temperature	-35°C to +60°C
Resistance to climatic conditions	acc. to IEC/EN 61008
Humidity	5-95 %
Pollution degree	2
Contact position indicator	red / green
Tripping indicator	white / blue

Connection diagram

2-poles

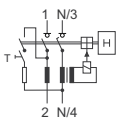

4-poles

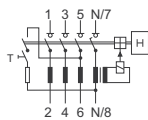

Dimensions (mm)

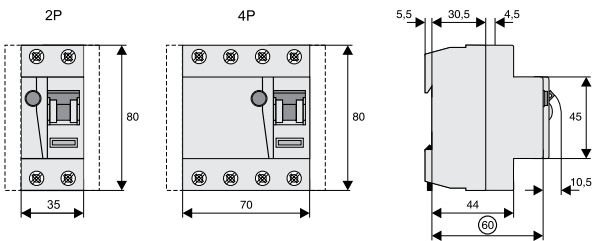

Correct connection

2-poles acc. to IEC61008/UL1053

30, 300mA Types:

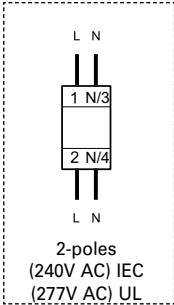

4-poles acc. to IEC61008

30mA Types:

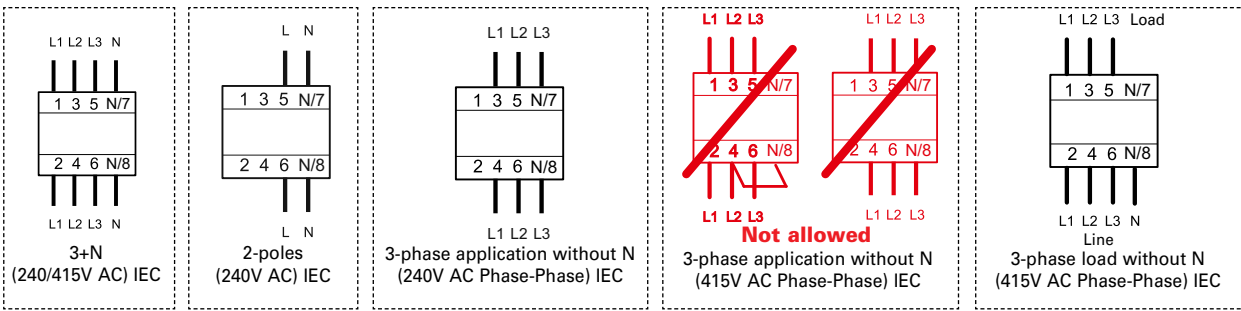

300mA Types:

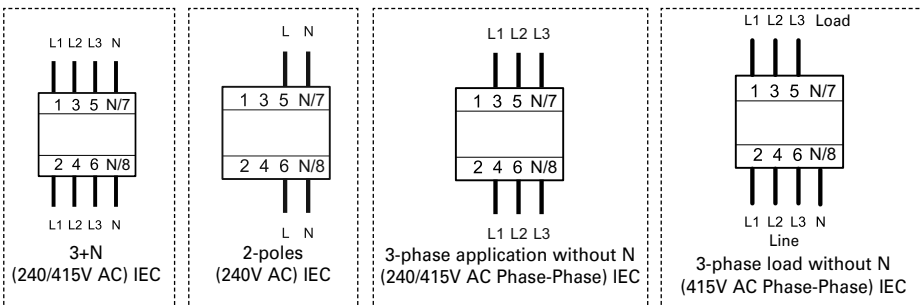

4-poles acc. to UL1053

30, 300mA Types:

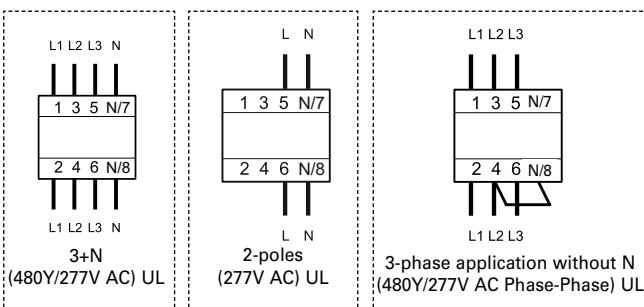

Impact of ambient temperature on the maximum permanent current allowed (A) FRCmM-NA

Ambient temperature	25A		40A		63A	
	2p	4p	2p	4p	2p	4p
40°	25	25	40	40	63	63
45°	21	22	37	37	59	59
50°	18	19	33	34	55	55
55°	14	16	30	31	50	50
60°	–	–	26	27	45	45
65°	–	–	20	24	40	41
70°	–	–	14	19	34	37
75°	–	–	8	15	28	31

Note: Please make sure that these values are not exceeded and that any upstream thermal overload protection switches off in time.

Max. back-up fuse FRCmM-NA (acc. to IEC)

Rating	Fuses		MCB's (Characteristic B/C)		
	In [A]	Short Circuit [A]	Overload [A]	Short Circuit [A]	Overload [A]
25	63 gG/gI	25 gG/gI	FAZ-C40	FAZ-C25	
40	63 gG/gI	40 gG/gI	FAZ-C40	FAZ-C40	
63	63 gG/gI	40 gG/gI	FAZ-C40	FAZ-C40	

Important:

In the case that the maximal possible operating current of the electrical installation don't exceed the rated current of the RCD only short circuit protection must be implemented. Overload protection must be implemented in the case if the maximal possible operating current of the electrical installation can exceed the rated current of the RCD.

Max. back-up fuse FRCmM-NA (acc. to UL)

Rating	Short Circuit [A]
25-63	70 J-Class Fuse

Important:

The maximal possible operating current of the electrical installation may not exceed the rated current of the RCD (VDE 0100-520 Bbl. 2).

SG49612



Description

- Line voltage independent RCCB for fault protection, additional protection as well as fire protection
- Certified according UL 1053 and IEC/EN 61008 to be used in 110V applications worldwide
- Comprehensive range of RCCBs available to fulfil most application needs
- Fault current tripping indicator enables to determine the tripping reason
- Comprehensive accessories available
- Suitable to be put into rail rolling stock applications due to additional certification

$I_n/I_{\Delta n}$ (A)	Operating frequency (Hz)	Type Designation	Article No.	Units per package
---------------------------	-----------------------------	---------------------	-------------	----------------------

Type A

Conditionally surge current-proof 250 A, sensitive to residual pulsating DC, Type A 

SG49612



4-poles

25/0.03	50/60	FRCmM-25/4/003-A-NA-110	167699	1/30
25/0.3	50/60	FRCmM-25/4/03-A-NA-110	167702	1/30
40/0.03	50/60	FRCmM-40/4/003-A-NA-110	167700	1/30
40/0.3	50/60	FRCmM-40/4/03-A-NA-110	167703	1/30
63/0.03	50/60	FRCmM-63/4/003-A-NA-110	167701	1/30
63/0.3	50/60	FRCmM-63/4/03-A-NA-110	167704	1/30

Type G/A

Surge current-proof 3 kA, sensitive to residual pulsating DC, Type G/A (ÖVE E 8601) 

SG49612



2-poles

25/0.03	50/60	FRCmM-25/2/003-G/A-NA-110	167693	1/60
25/0.3	50/60	FRCmM-25/2/03-G/A-NA-110	167696	1/60
40/0.03	50/60	FRCmM-40/2/003-G/A-NA-110	167694	1/60
40/0.3	50/60	FRCmM-40/2/03-G/A-NA-110	167697	1/60
63/0.03	50/60	FRCmM-63/2/003-G/A-NA-110	167695	1/60
63/0.3	50/60	FRCmM-63/2/03-G/A-NA-110	167698	1/60

SG49612



4-poles

25/0.03	50/60	FRCmM-25/4/003-G/A-NA-110	167705	1/30
25/0.3	50/60	FRCmM-25/4/03-G/A-NA-110	167708	1/30
40/0.03	50/60	FRCmM-40/4/003-G/A-NA-110	167706	1/30
40/0.3	50/60	FRCmM-40/4/03-G/A-NA-110	167709	1/30
63/0.03	50/60	FRCmM-63/4/003-G/A-NA-110	167707	1/30
63/0.3	50/60	FRCmM-63/4/03-G/A-NA-110	167710	1/30

Specifications | Residual Current Devices FRcmM-NA-110

Description

Design

- Residual Current Circuit Breakers (RCCBs) for worldwide industrial and commercial applications which operate with 110V
- Designed and suitable to be put into an xEffect-System
- Twin-purpose terminal (lift/open-mouthed) above and below
- Contact position indicator red - green
- Tripping indicator white - blue
- Additional safety due:
 - possibility to seal the toggle
 - possibility to lock the toggle
- The device functions irrespective of the position of installation

Accessories

- Busbar positioning optionally above or below
- Free terminal space despite installed busbar
- Auxiliary contacts to be mounted onto the device:
 - Universal tripping signal switch, also suitable for FAZ, FRBmM-1N
 - Auxiliary switch Z-HK can be mounted subsequently

Additional information for the application

- Delayed types suitable for being used with standard fluorescent tubes with or without electronical ballast
 - 30 mA-RCCBs: 30 units per phase conductor
 - 100 mA RCCBs: 90 units per phase conductor

Note: Depending on the fluorescent lamp manufacturer, partly more units possible. Symmetrical allocation of the fluorescent lamp ballasts on all phases favorably. Please still consider the technical data provided by the manufacturer of the lamps.
- Tripping is line voltage independent (VI) and therefore suitable for all BA-classes.

The RCD is suitable for fault protection, additional protection, fire protection within the regulations of the applicable wiring regulations (e.g.: IEC/EN 60364)
- The 4-pole device can also be used for 3-pole and 2 pole applications. Please refer to published connection diagrams

Test Button

- The test button "T" must be pressed once every 6 months. The system operator must be informed of this obligation and his responsibility in a way that can be proven.

Under special conditions (e.g.: damply and/or dusty environments, environments with polluting and/or corroding conditions, environments with large temperature fluctuations, installations with a risk of overvoltage due to switching of equipment and/or atmospheric discharges, portable equipment, ...), it's recommended to test in monthly intervals. Regulations according IEC/EN 60364 or wiring regulations still apply.
- The test button "T" tests the function of the RCCB itself. This test does not measure a "suitable" fault loop or if requirements of such are kept. Testing your fault loop (earth rod resistance, continuity of fault loop,...) requires special tests performed separately.
- **Type A:** These types are capable of sensing pulsating residual currents and are not negatively affected by a DC overlay of up to 6mA. These devices are also available as:
 - G/A short time delayed devices which are surge current proof up to 3kA. These devices enable a reliable and safe installation with increased system availability
- **Type G:** G Types offer a 10ms time delayed tripping curve and surge current proof capabilities up to 3kA and are highly recommended to be used for applications and installations where system availability is an important factor. Since "G" states a tripping curve and not a sensitivity, these devices can also be found as:
 - A Type RCCBs (-G/A-NA)

Accessories:

Auxiliary contact to be mounted on the left side	Z-HK	248432
Auxiliary contact to be mounted on the right side	Z-NHK	248434
Automatic restarting device	Z-FW/LP	248296
	Z-FW-LPD	265244
Remote control unit	Z-FW-MO	284730
Sets (Device + remote control unit)	Z-FW-LP/MO	290171
	Z-FW-LPD/MO	290172
IΔn testing module	Z-FW/003	248298
	Z-FW/010	248299
	Z-FW/030	248300
	Z-RC/AK-4TE	101062
Terminal cover 4-poles	Z-RC/AK-4TE	101062

Technical Data

		FRCmM-NA-110
Electrical according to IEC/EN 61008		
Design according to		IEC/EN 61008, ÖVE E 8601
Classified according to		IEC 61373, EN 45545-2
Current test marks as printed onto the device		
Tripping		instantaneous
Type G		10 ms delay at 50 Hz
Rated voltage	U_n	110/190 V, 50/60Hz
Limits operation voltage test circuit		
2-poles		94 - 121 V~
4-poles 30 mA		94 - 121 V~
4-poles 300 mA		94 - 210 V~
Rated tripping current	$I_{\Delta n}$	30, 300 mA
Sensitivity		AC and pulsating DC
Rated insulation voltage	U_i	440 V
Rated impulse withstand voltage	U_{imp}	4 kV (1.2/50µs)
Rated short circuit capacity	I_{cn}	10 kA with back-up fuse
Peak withstand current		
Type A		250 A (8/20 µs) surge current-proof
Type G/A		3 kA (8/20 µs) surge current-proof, 10 ms delay
Rated breaking capacity	I_m	500 A
or rated fault breaking capacity	$I_{\Delta m}$	
$I_n = 25-40$ A		
		630 A
$I_n = 63$ A		
Endurance		
electrical components		≥ 4,000 operating cycles
mechanical components		≥ 10,000 operating cycles
Electrical according to UL1053		
Design according to		UL1053
Current test marks as printed onto the device		
Tripping		instantaneous
Type G		8 ms delay at 60 Hz
Rated voltage	U_n	208/120 V, 60 Hz
Limits operation voltage test circuit		
2-poles		94 - 132 V~
4-poles 30 mA		94 - 132 V~
4-poles 300 mA		94 - 230 V~
Pick-up current		
30 mA Types		22 mA
300 mA Types		200 mA
Sensitivity		AC and pulsating DC
Overvoltage tested		530 V
Rated impulse withstand voltage	U_{imp}	4 kV (1.2/50µs)
Rated short circuit capacity	I_{cn}	5 kA acc. to CSA
Rated breaking capacity	I_m	500 A
or rated fault breaking capacity	$I_{\Delta m}$	
$I_n = 25-40$ A		
		630 A
$I_n = 63$ A		
Endurance		
electrical components		≥ 4,000 operating cycles
mechanical components		≥ 10,000 operating cycles

Mechanical

Frame size	45 mm
Device height	80 mm
Device width	35 mm (2MU), 70 mm (4MU)
Mounting	quick fastening with 2 lock-in positions on DIN rail IEC/EN 60715
Degree of protection, built-in	IP40
Degree of protection in moisture-proof enclosure	IP54
Upper and lower terminals	lift terminals
Terminal protection	finger and hand touch safe, DGUV VS3, EN 50274
Terminal capacity	1.5 - 35 mm ² single wire 2 x 16 mm ² multi wire
Terminal screw	M5 (with slotted screw acc. to EN ISO 4757-Z2, Pozidriv PZ2)
Operation temperature	-25°C to +40°C
Storage- and transport temperature	-35°C to +60°C
Resistance to climatic conditions	acc. to IEC/EN 61008
Humidity	5-95 %
Pollution degree	2
Contact position indicator	red / green
Tripping indicator	white / blue

Connection diagram

2-poles

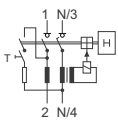

4-poles

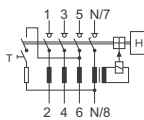

Dimensions (mm)

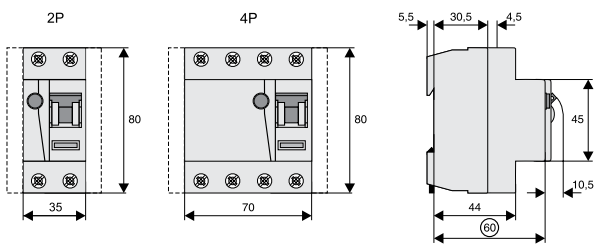

Correct connection

2-poles

30, 300mA Types:

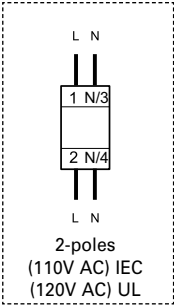

4-poles

30, 300mA Types:

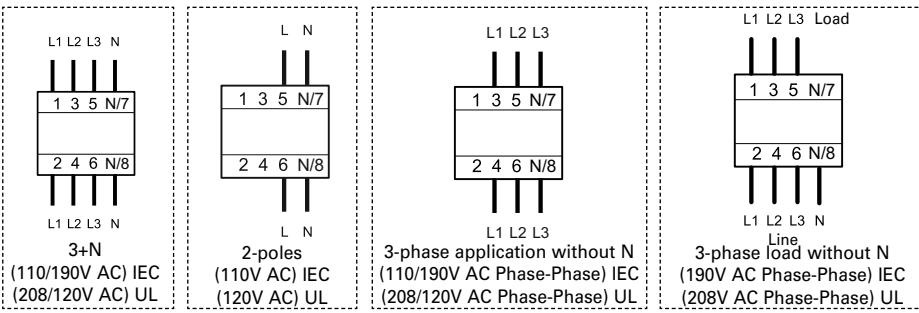

Impact of ambient temperature on the maximum permanent current allowed (A) FRCmM-NA-110

Ambient temperature	25A		40A		63A	
	2p	4p	2p	4p	2p	4p
40°	25	25	40	40	63	63
45°	21	22	37	37	59	59
50°	18	19	33	34	55	55
55°	14	16	30	31	50	50
60°	–	–	26	27	45	45
65°	–	–	20	24	40	41
70°	–	–	14	19	34	37
75°	–	–	8	15	28	31

Note: Please make sure that these values are not exceeded and that any upstream thermal overload protection switches off in time.

Max. back-up fuse FRCmM-NA-110 (acc. to IEC)

Rating In [A]	Fuses		MCB's (Characteristic B/C)	
	Short Circuit [A]	Overload [A]	Short Circuit [A]	Overload [A]
25	63 gG/gI	25 gG/gI	FAZ-C40	FAZ-C25
40	63 gG/gI	40 gG/gI	FAZ-C40	FAZ-C40
63	63 gG/gI	40 gG/gI	FAZ-C40	FAZ-C40

Important:
In the case that the maximal possible operating current of the electrical installation don't exceed the rated current of the RCD only short circuit protection must be implemented. Overload protection must be implemented in the case if the maximal possible operating current of the electrical installation can exceed the rated current of the RCD.

Max. back-up fuse FRCmM-NA-110 (acc. to UL)

Rating In [A]	Short Circuit [A]
25-63	70 J-Class Fuse

Important:
The maximal possible operating current of the electrical installation may not exceed the rated current of the RCD (VDE 0100-520 Bbl. 2).

SG08013



Description

- Comprehensive range of RCCBs with a rating of 125A
- All current sensitive Type B RCCBs to fulfil highest safety standards
- Line voltage independent 2 and 4 pole RCCB for fault protection, additional protection as well as fire protection
- As also stated in IEC/EN 62423, the B sensitivity relies on line voltage

$I_n/I_{\Delta n}$ (A)	Operating frequency (Hz)	Type Designation	Article No.	Units per package
---------------------------	-----------------------------	---------------------	-------------	----------------------

Type AC

Conditionally surge current-proof 250 A, Type AC 

SG07913



2-poles

125/0,03	50	FRCMM-125/2/003	187810	1/60
125/0,1	50	FRCMM-125/2/01	187811	1/60
125/0,3	50	FRCMM-125/2/03	187812	1/60
125/0,5	50	FRCMM-125/2/05	187813	1/60

SG08013



4-poles

125/0,03	50	FRCMM-125/4/003	187814	1/30
125/0,1	50	FRCMM-125/4/01	187815	1/30
125/0,3	50	FRCMM-125/4/03	187816	1/30
125/0,5	50	FRCMM-125/4/05	187817	1/30

Type A

Conditionally surge current-proof 250 A, sensitive to residual pulsating DC, Type A 

SG07913



2-poles

125/0.03	50	FRCMM-125/2/003-A	171164	1/60
125/0.1	50	FRCMM-125/2/01-A	171165	1/60
125/0.3	50	FRCMM-125/2/03-A	171166	1/60
125/0.5	50	FRCMM-125/2/05-A	171167	1/60

SG08013



4-poles

125/0.03	50	FRCMM-125/4/003-A	171174	1/30
125/0.1	50	FRCMM-125/4/01-A	171175	1/30
125/0.3	50	FRCMM-125/4/03-A	171176	1/30
125/0.5	50	FRCMM-125/4/05-A	171177	1/30

$I_n/I_{\Delta n}$ (A)	Operating frequency (Hz)	Type Designation	Article No.	Units per package
---------------------------	-----------------------------	---------------------	-------------	----------------------

Type G/A

Short-time delayed, surge current-proof 3 kA, sensitive to residual pulsating DC, Type G/A 

SG07913



2-poles

125/0.03	50	FRCMM-125/2/003-G/A	171168	1/60
125/0.1	50	FRCMM-125/2/01-G/A	171169	1/60
125/0.3	50	FRCMM-125/2/03-G/A	171170	1/60

SG08013



4-poles

125/0.03	50	FRCMM-125/4/003-G/A	171178	1/30
125/0.1	50	FRCMM-125/4/01-G/A	171179	1/30
125/0.3	50	FRCMM-125/4/03-G/A	171180	1/30

Type S/A

Selective + surge current-proof 5 kA, sensitive to residual pulsating DC, Type S/A 

SG07913



2-poles

125/0.1	50	FRCMM-125/2/01-S/A	171171	1/60
125/0.3	50	FRCMM-125/2/03-S/A	171172	1/60
125/0.5	50	FRCMM-125/2/05-S/A	171173	1/60

SG08013



4-poles

125/0.1	50	FRCMM-125/4/01-S/A	171181	1/30
125/0.3	50	FRCMM-125/4/03-S/A	171182	1/30
125/0.5	50	FRCMM-125/4/05-S/A	171183	1/30

$I_n/I_{\Delta n}$ (A)	Operating frequency (Hz)	Type Designation	Article No.	Units per package
---------------------------	-----------------------------	---------------------	-------------	----------------------

Type B

Surge current-proof 3 kA, all-current sensitive, Type B 

SG08013



4-poles

125/0.03	50	FRCMM-125/4/003-B	171184	1/30
125/0.1	50	FRCMM-125/4/01-B	171185	1/30
125/0.3	50	FRCMM-125/4/03-B	171186	1/30
125/0.5	50	FRCMM-125/4/05-B	171187	1/30

Type G/B

Short-time delayed, surge current-proof 3 kA, all-current sensitive, Type G/B 

SG08013



4-poles

125/0.03	50	FRCMM-125/4/003-G/B	171188	1/30
----------	----	---------------------	--------	------

Type S/Bfq

Selective + surge current-proof 5 kA, all-current sensitive, Type S/Bfq 

SG08013



4-poles

125/0.3	50	FRCMM-125/4/03-S/BFQ	171190	1/30
125/0.5	50	FRCMM-125/4/05-S/BFQ	171191	1/30

Type G/B+

Short-time delayed, surge current-proof 3 kA, all-current sensitive, Type G/B+ 

SG08013



4-poles

125/0.03	50	FRCMM-125/4/003-G/B+	171189	1/30
----------	----	----------------------	--------	------

Specifications | Residual Current Devices FRcmM-125, Type A

Description**Design**

- Residual Current Circuit Breakers (RCCBs) for application with higher rated nominal current
- Twin-purpose terminal (lift/open-mouthed) above and below
- Contact position indicator red - green
- The device functions irrespective of the position of installation

Accessories

- Auxiliary contact Z-HD to be mounted onto the device

Additional information for the application

- Tripping is line voltage independent (VI) and therefore suitable for all BA-classes.

The RCD is suitable for fault protection, additional protection, fire protection within the regulations of the applicable wiring regulations (e.g.: IEC/EN 60364)

Test Button

- The test button "T" must be pressed once every 6 months. The system operator must be informed of this obligation and his responsibility in a way that can be proven.
Under special conditions (e.g.: damply and/or dusty environments, environments with polluting and/or corroding conditions, environments with large temperature fluctuations, installations with a risk of overvoltage due to switching of equipment and/or atmospheric discharges, portable equipment, ...), it's recommended to test in monthly intervals. Regulations according IEC/EN 60364 or wiring regulations still apply.
- The test button "T" tests the function of the RCCB itself. This test does not measure a "suitable" fault loop or if requirements of such are kept. Testing your fault loop (earth rod resistance, continuity of fault loop,...) requires special tests performed separately.

- **Type A:** These types are capable of sensing pulsating residual currents and are not negatively affected by a DC overlay of up to 6mA. These devices (dependent on the range) are also available as:
 - G/A short time delayed devices which are surge current proof up to 3 kA. These devices enable a reliable and safe installation with increased system availability
 - S/A selective RCCBs with improved surge current capabilities up to 5 kA. These devices are selective (conditions apply) to other RCDs and enable special applications and root installations.
- **Type G:** G Types offer a 10ms time delayed tripping curve and surge current proof capabilities up to 3kA and are highly recommended to be used for applications and installations where system availability is an important factor. Since "G" states a tripping curve and not a sensitivity, these devices (dependent on the range) will be found as:
 - A Type RCCBs (-G/A)
- **Type S:** S Types offer a 40ms time delayed tripping curve and surge current proof capabilities up to 5kA and are known as "selective" types. These devices are mainly used in root applications with additional RCDs deployed in series in the system. Since "S" states a tripping curve and not a sensitivity, these devices (dependent on the range) will be found as:
 - S/A Type RCCBs

Accessories:

 Auxiliary switch for subsequent installation to the left

Z-HD

265620

Technical Data

		FRCmM-125A, Type AC, A, G/A and S/A
Electrical		
Design according to		IEC/EN 61008
Current test marks as printed onto the device		
Tripping		instantaneous
Type G/A		10 ms delay
Type S/A		50 ms delay - with selective disconnecting function
Rated voltage	U_n	240/415 V; 50 Hz
Limits operation voltage test circuit		
30 mA		150 - 250 V~
100, 300, 500 mA		185 - 440 V~
Rated tripping current	$I_{\Delta n}$	30, 100, 300, 500 mA
Sensitivity		AC and pulsating DC
Rated insulation voltage	U_i	400 V
Rated impulse withstand voltage	U_{imp}	2,5 kV
Rated short circuit capacity	I_{cn}	10 kA with back-up fuse
Peak withstand current		
Type A		250 A (8/20 μ s), surge current-proof
Type G/A		3 kA (8/20 μ s), surge current-proof, 10 ms delay
Type S/A		5 kA (8/20 μ s), surge current-proof, 40 ms delay
Maximum back-up fuse		Short circuit protection Overload protection 125 A gG/gL 80 A gG/gL
Rated breaking capacity	I_m	1250 A
or rated fault breaking capacity	$I_{\Delta m}$	
Endurance		
electrical components		$\geq 4,000$ operating cycles
mechanical components		$\geq 10,000$ operating cycles
Mechanical		
Frame size		45 mm
Device height		80 mm
Device width		35 mm (2MU), 70 mm (4MU)
Mounting		quick fastening with DIN rail EN50022
Degree of protection, built-in		IP40
Upper and lower terminals		open mouthed/lift terminals
Terminal protection		finger and hand touch safe, DGUV VS3, EN 50274
Terminal capacity		1,5 - 50 mm ²
Busbar thickness		0.8 - 2 mm
Operation temperature		-25°C to +40°C
Storage- and transport temperature		-25°C to +60°C
Resistance to climatic conditions		25-55°C/90-95% relative humidity acc. to IEC 60068-2
Mounting position		any

Connection diagram

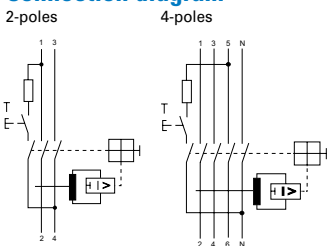

Dimensions (mm)

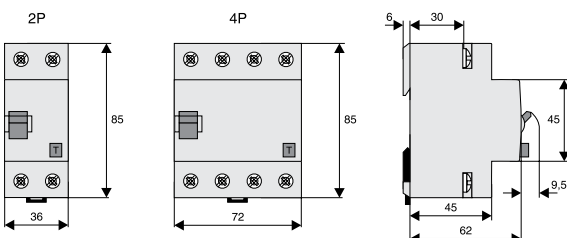

Power Loss at I_n FRcmM-125 - Type AC, A, G/A and S/A

(entire unit)

I_n [A]	P [W]
2-poles	
125	18
4-poles	
125	22.5

Specifications | Residual Current Devices FRCmM-125, Type B, Bfg and B+

Description

Design

- All current sensitive Residual Current Circuit Breakers (RCCBs) for application with higher rated nominal current
- Twin-purpose terminal (lift/open-mouthed) above and below
- Contact position indicator red - green
- The device functions irrespective of the position of installation

Accessories

- Auxiliary contact Z-HD to be mounted onto the device

Additional information for the application

- Tripping is line voltage independent (VI) and therefore suitable for all BA-classes.

The RCD is suitable for fault protection, additional protection, fire protection within the regulations of the applicable wiring regulations (e.g.: IEC/EN 60364)

- As also stated in IEC/EN 62423, the B sensitivity relies on line voltage

Test Button

- The test button "T" must be pressed once every 6 months. The system operator must be informed of this obligation and his responsibility in a way that can be proven.
Under special conditions (e.g.: damply and/or dusty environments, environments with polluting and/or corroding conditions, environments with large temperature fluctuations, installations with a risk of overvoltage due to switching of equipment and/or atmospheric discharges, portable equipment, ...), it's recommended to test in monthly intervals. Regulations according IEC/EN 60364 or wiring regulations still apply.
- The test button "T" tests the function of the RCCB itself. This test does not measure a "suitable" fault loop or if requirements of such are kept. Testing your fault loop (earth rod resistance, continuity of fault loop,...) requires special tests performed separately.

- **Type B (fq, +):** These types offer the highest safety levels in electrical systems due to their all-current sensitivity and best in class reliability and system availability. Special type B from Eaton are available:

- B+ limit the possibility of electrical ignited fires and should be considered for fire hazard applications as also mentioned in VDE-0664-400

- Bfq are capable of reliably sensing residual currents up to 100 kHz

- **Type G:** G Types offer a 10 ms time delayed tripping curve and surge current proof capabilities up to 3 kA and are highly recommended to be used for applications and installations where system availability is an important factor.

Since "G" states a tripping curve and not a sensitivity, these devices (dependent on the range) will be found as:

- B/B+ Type RCCBs (-G/B(+))

- **Type S:** S Types offer a 40 ms time delayed tripping curve and surge current proof capabilities up to 5 kA and are known as "selective" types. These devices are mainly used in root applications with additional RCDs deployed in series in the system.

Since "S" states a tripping curve and not a sensitivity, these devices (dependent on the range) will be found as:

- S/Bfq Type RCCBs

Accessories:

Auxiliary switch for subsequent installation to the left	Z-HD	265620
--	------	--------

Technical Data

		FRCmM-125A, Type B, Bfg and B+
Electrical		
Design according to		IEC/EN 61008
Current test marks as printed onto the device		
Tripping		
Type B, G/B, G/B+		short-time delayed
Type S/Bfg		50 ms delay - with selective disconnecting function
Rated voltage	U_n	240/415 V; 50 Hz
Limits operation voltage test circuit		
30 mA		250 - 440 V~
100, 300, 500 mA		185 - 440 V~
Rated tripping current	$I_{\Delta n}$	30, 100, 300, 500 mA
Sensitivity		All types of current
Rated insulation voltage	U_i	400 V
Rated impulse withstand voltage	U_{imp}	2,5 kV
Rated short circuit capacity	I_{cn}	10 kA with back-up fuse
Peak withstand current		
Type B		3 kA (8/20 μ s), surge current-proof
Type G/B, G/Bfg, G/B+		3 kA (8/20 μ s), surge current-proof, 10 ms delay
Type S/Bfg		5 kA (8/20 μ s), surge current-proof, 40 ms delay
Maximum back-up fuse		
		Short circuit protection Overload protection
		125 A gG/gL 80 A gG/gL
Rated breaking capacity	I_m	1250 A
or rated fault breaking capacity	$I_{\Delta m}$	
Endurance		
electrical components		$\geq 4,000$ operating cycles
mechanical components		$\geq 10,000$ operating cycles
Mechanical		
Frame size		45 mm
Device height		80 mm
Device width		70 mm (4MU) für 2-poles and 4-poles
Mounting		quick fastening with DIN rail EN50022
Degree of protection, built-in		IP40
Upper and lower terminals		open mouthed/lift terminals
Terminal protection		finger and hand touch safe, DGUV VS3, EN 50274
Terminal capacity		1,5 - 50 mm ²
Busbar thickness		0.8 - 2 mm
Operation temperature		-25°C to +40°C
Storage- and transport temperature		-25°C to +60°C
Resistance to climatic conditions		25-55°C/90-95% relative humidity acc. to IEC 60068-2
Mounting position		any

Connection diagram

4-poles

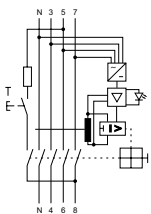

Dimensions (mm)

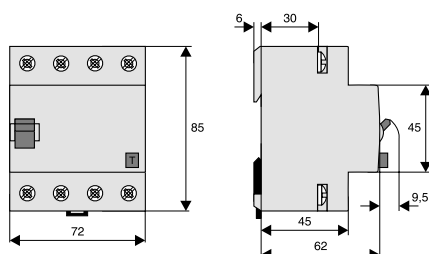

Power Loss at I_n FRCmM-125 - Type B, Bfg and B+

(entire unit)

I_n [A]	P [W]
4-poles	
125	22.5

Tripping current frequency response FRCmM-125 - Type B, Bfg and B+

Tripping current frequency response 30 mA Type B

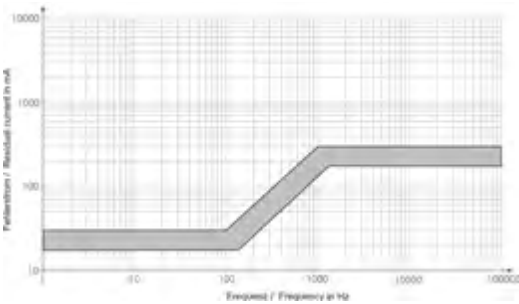

Tripping current frequency response 30 mA Type G/B+

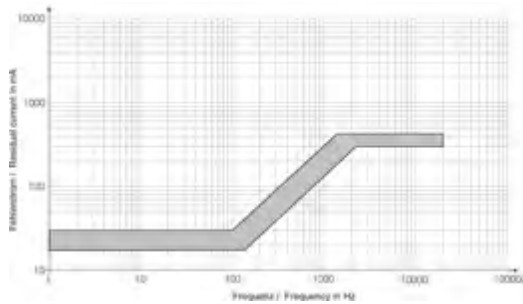

Tripping current frequency response 30 mA Type G/B

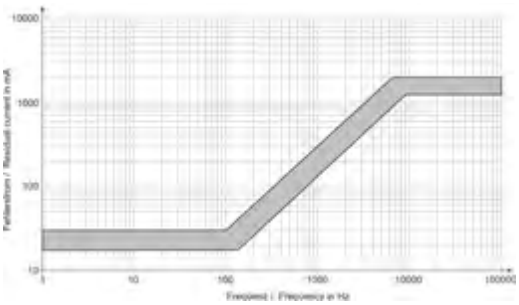

Tripping current frequency response 100 mA Type B

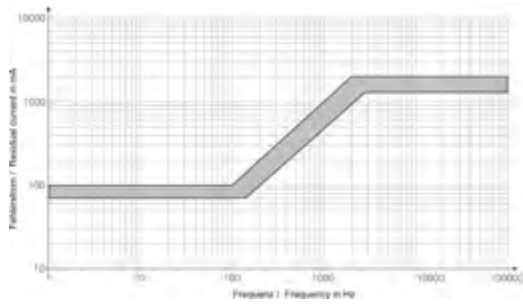

Tripping current frequency response 300 mA Type S/Bfg

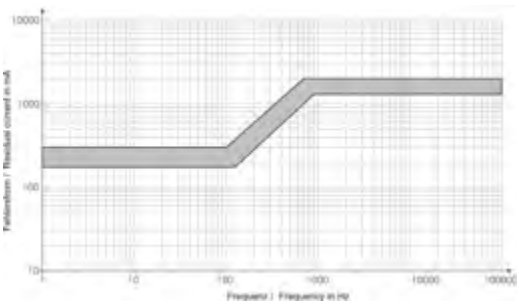

Tripping current frequency response 500 mA Type S/Bfg

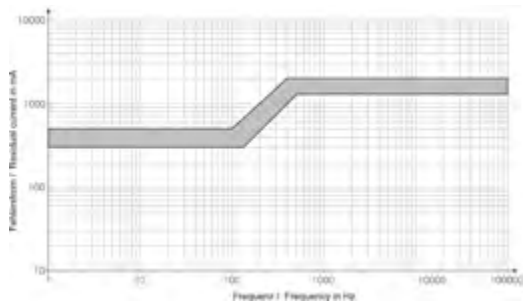

SG08013





Description

- Comprehensive range of RCCBs with a rating of up to 80A
- Higher tripping currents for special applications
- All current sensitive Type B RCCBs to fulfil highest safety standards
- Line voltage independent 2 and 4 pole RCCB for fault protection, additional protection as well as fire protection

$I_n/I_{\Delta n}$ (A)	Operating frequency (Hz)	Type Designation	Article No.	Units per package
---------------------------	-----------------------------	---------------------	-------------	----------------------

Type B

Conditionally surge current-proof 250 A, Type B   



SG08013



4-poles

40/0.1	50	FRCMM-40/4/01-B	187804	1/30
63/0.1	50	FRCMM-63/4/01-B	187805	1/30
63/0.5	50	FRCMM-63/4/05-B	303861	1/30
80/0.03	50	FRCMM-80/4/003-B	187806	1/30
80/0.1	50	FRCMM-80/4/01-B	187807	1/30
80/0.3	50	FRCMM-80/4/03-B	187808	1/30
80/0.5	50	FRCMM-80/4/05-B	303862	1/30

Type S/B

Selective + surge current-proof 5 kA, all-current sensitive, Type S/B   

SG08013



4-poles

80/0,3	50	FRCMM-80/4/03-S/B	187809	1/30
--------	----	-------------------	--------	------

Specifications | Residual Current Devices FRcM, Type B

Description**Design**

- All current sensitive Residual Current Circuit Breakers (RCCBs) for special applications
- Twin-purpose terminal (lift/open-mouthed) above and below
- Contact position indicator red - green
- The device functions irrespective of the position of installation

Accessories

- Auxiliary contact Z-HD to be mounted onto the device

Additional information for the application

- Tripping is line voltage independent (VI) and therefore suitable for all BA-classes.

The RCD is suitable for fault protection, additional protection, fire protection within the regulations of the applicable wiring regulations (e.g.: IEC/EN 60364)

- As also stated in IEC/EN 62423, the B sensitivity relies on line voltage

Test Button

- The test button "T" must be pressed once every 6 months. The system operator must be informed of this obligation and his responsibility in a way that can be proven.

Under special conditions (e.g.: damply and/or dusty environments, environments with polluting and/or corroding conditions, environments with large temperature fluctuations, installations with a risk of overvoltage due to switching of equipment and/or atmospheric discharges, portable equipment, ...), it's recommended to test in monthly intervals. Regulations according IEC/EN 60364 or wiring regulations still apply.

- The test button "T" tests the function of the RCCB itself. This test does not measure a "suitable" fault loop or if requirements of such are kept. Testing your fault loop (earth rod resistance, continuity of fault loop,...) requires special tests performed separately.

- **Type B:** These types offer the highest safety levels in electrical systems due to their all-current sensitivity and best in class reliability and system availability.

Accessories:

Auxiliary switch for subsequent installation to the left	Z-HD	265620
--	------	--------

Technical Data

		FRCmM, Type B	
Electrical			
Design according to		IEC/EN 61008, IEC/EN 62423	
Current test marks as printed onto the device			
Tripping			
Type B		short-time delayed	
Type S/B		50 ms delay - with selective disconnecting function	
Rated voltage	U_n	230/400 V; 50 Hz	
Limits operation voltage test circuit			
30 mA		250 - 440 V~	
100, 300, 500 mA		185 - 440 V~	
Rated tripping current	$I_{\Delta n}$	30, 100, 300, 500 mA	
Sensitivity		All types of current	
Rated insulation voltage	U_i	400 V	
Rated impulse withstand voltage	U_{imp}	2,5 kV	
Rated short circuit capacity	I_{cn}	10 kA with back-up fuse	
Peak withstand current			
Type B		3 kA (8/20 μ s), surge current-proof, 10 ms delay	
Type S/B		5 kA (8/20 μ s), surge current-proof, 40 ms delay	
Maximum back-up fuse		Short circuit protection	Overload protection
$I_n = 40$ A		100 A gG/gL	40 A gG/gL
$I_n = 63$ A		100 A gG/gL	63 A gG/gL
$I_n = 80$ A		100 A gG/gL	80 A gG/gL
Rated breaking capacity or rated fault breaking capacity		I_m	
$I_n = 40$ A		$I_{\Delta m}$	500 A
$I_n = 63$ A			630 A
$I_n = 80$ A			800 A
Endurance			
electrical components		$\geq 4,000$ operating cycles	
mechanical components		$\geq 10,000$ operating cycles	
Mechanical			
Frame size		45 mm	
Device height		80 mm	
Device width		70 mm (4MU)	
Mounting		quick fastening with DIN rail EN50022	
Degree of protection, built-in		IP40	
Upper and lower terminals		open mouthed/lift terminals	
Terminal protection		finger and hand touch safe, DGUV VS3, EN 50274	
Terminal capacity		1,5 - 50 mm ²	
Busbar thickness		0.8 - 2 mm	
Operation temperature		-25°C to +40°C	
Storage- and transport temperature		-25°C to +60°C	
Resistance to climatic conditions		25-55°C/90-95% relative humidity acc. to IEC 60068-2	
Mounting position		any	

Connection diagram

4-poles

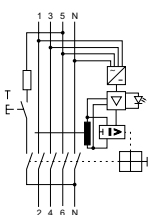

Dimensions (mm)

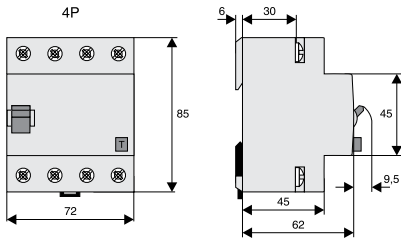

Power Loss at I_n FRCmM - Type B

(entire unit)

I_n [A]	P [W]
4-poles	
40	1.3
63	3.1
80	5.0

SG05613



Description

- High-quality residual current device / miniature circuit breaker combination, line voltage-dependent
- 1+N-poles and 2-poles
- Increased protection in applications with 1-phase frequency converter due to the detection of mixed frequencies (type F)
- Reduction of nuisance tripping (type F or G/A) thanks to
 - time delayed tripping
 - increased current withstand capability
 - 3 kA
- Higher load rating with DC residual currents up to 10 mA (Type F)
- Contact position indicator red - green
- Tripping indicator white - blue
- New level of accuracy due to electronic fault current detection
- Local status indication of residual current through 3 LEDs
- 3-position DIN rail clip, permits removal from existing busbar system
- Comprehensive range of accessories suitable for subsequent installation
- Wide variety of rated tripping currents
- Rated currents up to 25 A
- Tripping characteristics B, C, D
- Rated breaking capacity 10 kA

$I_n/I_{\Delta n}$ (A) Type Designation Article No. Units per package

Type F

10 kA, 1+N-poles

Sensitive to residual pulsating DC, surge current proof 3000 A, type F  

SG05713



Characteristic B

10/0.01	FRBdM-B10/1N/001-F	300539	1/60
13/0.01	FRBdM-B13/1N/001-F	300567	1/60
16/0.01	FRBdM-B16/1N/001-F	300587	1/60
10/0.03	FRBdM-B10/1N/003-F	300540	1/60
13/0.03	FRBdM-B13/1N/003-F	300568	1/60
16/0.03	FRBdM-B16/1N/003-F	300588	1/60
10/0.1	FRBdM-B10/1N/01-F	300538	1/60
13/0.1	FRBdM-B13/1N/01-F	300566	1/60
16/0.1	FRBdM-B16/1N/01-F	300586	1/60

SG05713



Characteristic C

6/0.01	FRBdM-C6/1N/001-F	300518	
10/0.01	FRBdM-C10/1N/001-F	300546	
13/0.01	FRBdM-C13/1N/001-F	300570	
16/0.01	FRBdM-C16/1N/001-F	300590	
20/0.01	FRBdM-C20/1N/001-F	300612	
25/0.01	FRBdM-C25/1N/001-F	300629	
6/0.03	FRBdM-C6/1N/003-F	300519	
10/0.03	FRBdM-C10/1N/003-F	300547	
13/0.03	FRBdM-C13/1N/003-F	300571	
16/0.03	FRBdM-C16/1N/003-F	300591	
20/0.03	FRBdM-C20/1N/003-F	300613	
25/0.03	FRBdM-C25/1N/003-F	300630	
6/0.1	FRBdM-C6/1N/01-F	300517	
10/0.1	FRBdM-C10/1N/01-F	300541	
13/0.1	FRBdM-C13/1N/01-F	300569	
16/0.1	FRBdM-C16/1N/01-F	300589	
20/0.1	FRBdM-C20/1N/01-F	300611	
25/0.1	FRBdM-C25/1N/01-F	300628	

SG05713



Characteristic D

6/0.01	FRBdM-D6/1N/001-F	300521	
10/0.01	FRBdM-D10/1N/001-F	300549	
13/0.01	FRBdM-D13/1N/001-F	300573	
16/0.01	FRBdM-D16/1N/001-F	300593	
20/0.01	FRBdM-D20/1N/001-F	300615	
25/0.01	FRBdM-D25/1N/001-F	300632	
6/0.03	FRBdM-D6/1N/003-F	300522	
10/0.03	FRBdM-D10/1N/003-F	300550	
13/0.03	FRBdM-D13/1N/003-F	300574	
16/0.03	FRBdM-D16/1N/003-F	300594	
20/0.03	FRBdM-D20/1N/003-F	300616	
25/0.03	FRBdM-D25/1N/003-F	300633	
6/0.1	FRBdM-D6/1N/01-F	300520	
10/0.1	FRBdM-D10/1N/01-F	300548	
13/0.1	FRBdM-D13/1N/01-F	300572	
16/0.1	FRBdM-D16/1N/01-F	300592	
20/0.1	FRBdM-D20/1N/01-F	300614	
25/0.1	FRBdM-D25/1N/01-F	300631	

Type G/A

10 kA, 1+N-poles

Surge current-proof 3 kA, sensitive to residual pulsating DC, Type G/A (ÖVE E 8601) 

SG05713



Characteristic B

10/0.01	FRBdM-B10/1N/001-G/A	168249	1/60
13/0.01	FRBdM-B13/1N/001-G/A	168250	1/60
16/0.01	FRBdM-B16/1N/001-G/A	168251	1/60
10/0.03	FRBdM-B10/1N/003-G/A	168264	1/60
13/0.03	FRBdM-B13/1N/003-G/A	168265	1/60
16/0.03	FRBdM-B16/1N/003-G/A	168266	1/60
10/0.1	FRBdM-B10/1N/01-G/A	168279	1/60
13/0.1	FRBdM-B13/1N/01-G/A	168280	1/60
16/0.1	FRBdM-B16/1N/01-G/A	168281	1/60

SG05713



Characteristic C

6/0.01	FRBdM-C6/1N/001-G/A	168252	1/60
10/0.01	FRBdM-C10/1N/001-G/A	168253	1/60
13/0.01	FRBdM-C13/1N/001-G/A	168254	1/60
16/0.01	FRBdM-C16/1N/001-G/A	168255	1/60
20/0.01	FRBdM-C20/1N/001-G/A	168256	1/60
25/0.01	FRBdM-C25/1N/001-G/A	168257	1/60
6/0.03	FRBdM-C6/1N/003-G/A	168267	1/60
10/0.03	FRBdM-C10/1N/003-G/A	168268	1/60
13/0.03	FRBdM-C13/1N/003-G/A	168269	1/60
16/0.03	FRBdM-C16/1N/003-G/A	168270	1/60
20/0.03	FRBdM-C20/1N/003-G/A	168271	1/60
25/0.03	FRBdM-C25/1N/003-G/A	168272	1/60
6/0.1	FRBdM-C6/1N/01-G/A	168282	1/60
10/0.1	FRBdM-C10/1N/01-G/A	168283	1/60
13/0.1	FRBdM-C13/1N/01-G/A	168284	1/60
16/0.1	FRBdM-C16/1N/01-G/A	168285	1/60
20/0.1	FRBdM-C20/1N/01-G/A	168286	1/60
25/0.1	FRBdM-C25/1N/01-G/A	168287	1/60

SG05713



Characteristic D

6/0.01	FRBdM-D6/1N/001-G/A	168258	1/60
10/0.01	FRBdM-D10/1N/001-G/A	168259	1/60
13/0.01	FRBdM-D13/1N/001-G/A	168260	1/60
16/0.01	FRBdM-D16/1N/001-G/A	168261	1/60
20/0.01	FRBdM-D20/1N/001-G/A	168262	1/60
25/0.01	FRBdM-D25/1N/001-G/A	168263	1/60
6/0.03	FRBdM-D6/1N/003-G/A	168273	1/60
10/0.03	FRBdM-D10/1N/003-G/A	168274	1/60
13/0.03	FRBdM-D13/1N/003-G/A	168275	1/60
16/0.03	FRBdM-D16/1N/003-G/A	168276	1/60
20/0.03	FRBdM-D20/1N/003-G/A	168277	1/60
25/0.03	FRBdM-D25/1N/003-G/A	168278	1/60
6/0.1	FRBdM-D6/1N/01-G/A	168288	1/60
10/0.1	FRBdM-D10/1N/01-G/A	168289	1/60
13/0.1	FRBdM-D13/1N/01-G/A	168290	1/60
16/0.1	FRBdM-D16/1N/01-G/A	168291	1/60
20/0.1	FRBdM-D20/1N/01-G/A	168292	1/60
25/0.1	FRBdM-D25/1N/01-G/A	168293	1/60

$I_n/I_{\Delta n}$ (A)	Type Designation	Article No.	Units per package
---------------------------	---------------------	-------------	----------------------

Type F

10 kA, 2-poles

Sensitive to residual pulsating DC, surge current proof 3000 A, Type F  

SG05613



Characteristic B

10/0.01	FRBdM-B10/2/001-F	300524	1/60
13/0.01	FRBdM-B13/2/001-F	300553	1/60
16/0.01	FRBdM-B16/2/001-F	300577	1/60
10/0.03	FRBdM-B10/2/003-F	300525	1/60
13/0.03	FRBdM-B13/2/003-F	300554	1/60
16/0.03	FRBdM-B16/2/003-F	300578	1/60
10/0.1	FRBdM-B10/2/01-F	300523	1/60
13/0.1	FRBdM-B13/2/01-F	300551	1/60
16/0.1	FRBdM-B16/2/01-F	300575	1/60

SG05613



Characteristic C

6/0.01	FRBdM-C6/2/001-F	300512	1/60
10/0.01	FRBdM-C10/2/001-F	300529	1/60
13/0.01	FRBdM-C13/2/001-F	300556	1/60
16/0.01	FRBdM-C16/2/001-F	300580	1/60
20/0.01	FRBdM-C20/2/001-F	300599	1/60
25/0.01	FRBdM-C25/2/001-F	300623	1/60
6/0.03	FRBdM-C6/2/003-F	300513	1/60
10/0.03	FRBdM-C10/2/003-F	300531	1/60
13/0.03	FRBdM-C13/2/003-F	300557	1/60
16/0.03	FRBdM-C16/2/003-F	300581	1/60
20/0.03	FRBdM-C20/2/003-F	300607	1/60
25/0.03	FRBdM-C25/2/003-F	300624	1/60
6/0.1	FRBdM-C6/2/01-F	300511	1/60
10/0.1	FRBdM-C10/2/01-F	300527	1/60
13/0.1	FRBdM-C13/2/01-F	300555	1/60
16/0.1	FRBdM-C16/2/01-F	300579	1/60
20/0.1	FRBdM-C20/2/01-F	300597	1/60
25/0.1	FRBdM-C25/2/01-F	300622	1/60

SG05613



Characteristic D

6/0.01	FRBdM-D6/2/001-F	300515	1/60
10/0.01	FRBdM-D10/2/001-F	300535	1/60
13/0.01	FRBdM-D13/2/001-F	300563	1/60
16/0.01	FRBdM-D16/2/001-F	300583	1/60
20/0.01	FRBdM-D20/2/001-F	300609	1/60
25/0.01	FRBdM-D25/2/001-F	300626	1/60
6/0.03	FRBdM-D6/2/003-F	300516	1/60
10/0.03	FRBdM-D10/2/003-F	300537	1/60
13/0.03	FRBdM-D13/2/003-F	300565	1/60
16/0.03	FRBdM-D16/2/003-F	300584	1/60
20/0.03	FRBdM-D20/2/003-F	300610	1/60
25/0.03	FRBdM-D25/2/003-F	300627	1/60
6/0.1	FRBdM-D6/2/01-F	300514	1/60
10/0.1	FRBdM-D10/2/01-F	300534	1/60
13/0.1	FRBdM-D13/2/01-F	300562	1/60
16/0.1	FRBdM-D16/2/01-F	300582	1/60
20/0.1	FRBdM-D20/2/01-F	300608	1/60
25/0.1	FRBdM-D25/2/01-F	300625	1/60

$I_n/I_{\Delta n}$
(A)

Type
Designation

Article No.

Units per
package

Type G/A

10 kA, 2-poles

Surge current-proof 3 kA, sensitive to residual pulsating DC, Type G/A (ÖVE E 8601) 

SG05613



Characteristic B

10/0.01	FRBdM-B10/2/001-G/A	168294	1/60
13/0.01	FRBdM-B13/2/001-G/A	168295	1/60
16/0.01	FRBdM-B16/2/001-G/A	168296	1/60
10/0.03	FRBdM-B10/2/003-G/A	168198	1/60
13/0.03	FRBdM-B13/2/003-G/A	168199	1/60
16/0.03	FRBdM-B16/2/003-G/A	168200	1/60
10/0.1	FRBdM-B10/2/01-G/A	168213	1/60
13/0.1	FRBdM-B13/2/01-G/A	168214	1/60
16/0.1	FRBdM-B16/2/01-G/A	168215	1/60

SG05613



Characteristic C

6/0.01	FRBdM-C6/2/001-G/A	168297	1/60
10/0.01	FRBdM-C10/2/001-G/A	168298	1/60
13/0.01	FRBdM-C13/2/001-G/A	168299	1/60
16/0.01	FRBdM-C16/2/001-G/A	168300	1/60
20/0.01	FRBdM-C20/2/001-G/A	168301	1/60
25/0.01	FRBdM-C25/2/001-G/A	168302	1/60
6/0.03	FRBdM-C6/2/003-G/A	168201	1/60
10/0.03	FRBdM-C10/2/003-G/A	168202	1/60
13/0.03	FRBdM-C13/2/003-G/A	168203	1/60
16/0.03	FRBdM-C16/2/003-G/A	168204	1/60
20/0.03	FRBdM-C20/2/003-G/A	168205	1/60
25/0.03	FRBdM-C25/2/003-G/A	168206	1/60
6/0.1	FRBdM-C6/2/01-G/A	168216	1/60
10/0.1	FRBdM-C10/2/01-G/A	168217	1/60
13/0.1	FRBdM-C13/2/01-G/A	168218	1/60
16/0.1	FRBdM-C16/2/01-G/A	168219	1/60
20/0.1	FRBdM-C20/2/01-G/A	168220	1/60
25/0.1	FRBdM-C25/2/01-G/A	168221	1/60

SG05613



Characteristic D

6/0.01	FRBdM-D6/2/001-G/A	168303	1/60
10/0.01	FRBdM-D10/2/001-G/A	168304	1/60
13/0.01	FRBdM-D13/2/001-G/A	168305	1/60
16/0.01	FRBdM-D16/2/001-G/A	168195	1/60
20/0.01	FRBdM-D20/2/001-G/A	168196	1/60
25/0.01	FRBdM-D25/2/001-G/A	168197	1/60
6/0.03	FRBdM-D6/2/003-G/A	168207	1/60
10/0.03	FRBdM-D10/2/003-G/A	168208	1/60
13/0.03	FRBdM-D13/2/003-G/A	168209	1/60
16/0.03	FRBdM-D16/2/003-G/A	168210	1/60
20/0.03	FRBdM-D20/2/003-G/A	168211	1/60
25/0.03	FRBdM-D25/2/003-G/A	168212	1/60
6/0.1	FRBdM-D6/2/01-G/A	168222	1/60
10/0.1	FRBdM-D10/2/01-G/A	168223	1/60
13/0.1	FRBdM-D13/2/01-G/A	168224	1/60
16/0.1	FRBdM-D16/2/01-G/A	168225	1/60
20/0.1	FRBdM-D20/2/01-G/A	168226	1/60
25/0.1	FRBdM-D25/2/01-G/A	168227	1/60

Specifications | Combined RCD/MCB Devices FRBdM, digital

Description

- Combined RCD/MCB device
 - Line voltage-dependent tripping
 - Compatible with standard busbar
 - Twin-purpose terminal (lift/open-mouthed) above and below
 - Busbar positioning optionally above or below
 - Free terminal space despite installed busbar
 - Guide for secure terminal connection
 - Contact position indicator red - green
 - Fault current tripping indicator white - blue
 - Comprehensive range of accessories suitable for subsequent installation
 - The test key "T" must be pressed every year. The system operator must be informed of this obligation and his responsibility in a way that can be proven. Under special conditions (e.g. damply and/or dusty environments, environments with polluting and/or corroding conditions, environments with large temperature fluctuations, installations with a risk of overvoltages due to switching of equipment and/or atmospheric discharges, portable equipment ...), it's recommended to test in monthly intervals.
 - Pressing the test key "T" serves the only purpose of function testing the residual current device (RCD). This test does not make earthing resistance measurement (R_E), or proper checking of the earth conductor condition redundant, which must be performed separately.
- **Type -A:** Protects against special forms of residual pulsating DC which have not been smoothed.
 - **Type -G/A:** High reliability against unwanted tripping. Suitable for any circuit where personal injury or damage to property may occur in case of unwanted tripping. Additionally protects against special forms of residual pulsating DC which have not been smoothed.
 - **Type -F:** Sensitive to pulsating DC residual current and detection of multifrequency residual currents up to 1 kHz
 - Increased protection due to the detection of mixed frequencies
 - Higher load rating with DC residual currents up to 10mA
 - Reduction of nuisance tripping thanks to time delayed tripping and increased current withstand capability of 3 kA
 Recommended for washing machines, dish washers, or motor applications with single-phase drives.

Accessories:

Auxiliary switch for subsequent installation	ZP-IHK	286052
	ZP-WHK	286053
Tripping signal switch for subsequent installation	ZP-NHK	248437
Shunt trip release	ZP-ASA/..	248438, 248439
Terminal cover 2-poles	Z-TC/SD-2P	178099

Local Indication RCD

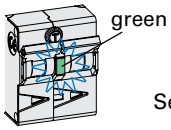

Self check (power ON) 2 s

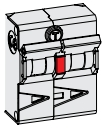

$I_{\Delta} \geq 50\% I_{\Delta n}$

red

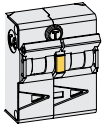

$I_{\Delta} = 30-50\% I_{\Delta n}$

amber

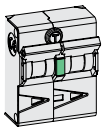

$I_{\Delta} \leq 30\% I_{\Delta n}$

green

Service Mode (measuring of residual current I_{Δ})

Pressing test button twice to activate Service-Mode

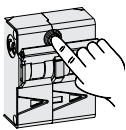

press
(0,1 - 0,4 s)

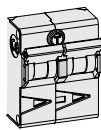

release
(0,1 - 0,4 s)

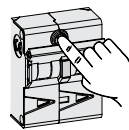

press
(0,1 - 0,4 s)

Measurement delimiter	red
Measurement delimiter ON time	400 ms
10 mA measurement color	amber
1 mA measurement color	green
Double-pressing test button to activate Service Mode	press (0.1-0.4 s) -> release (0.1-0.4 s) -> press (0.1-0.4 s)
Time duration of Service Mode	4 min (during activated Service Mode all protection functions are still working)

Lamp test

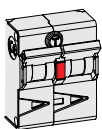

red

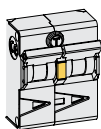

amber

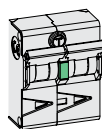

green

2 s
→

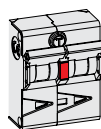

red

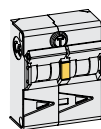

amber

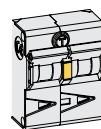

amber

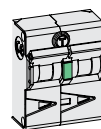

green

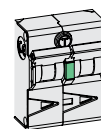

green

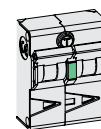

green

2 s
→

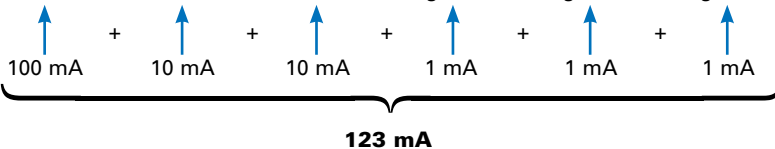

Technical Data

		FRBdM
Electrical		
Design according to		IEC/EN 61009 Type G according to ÖVE E 8601
Current test marks as printed onto the device		
Number of protected poles		
1+N-poles		1
2-poles		2
Tripping		
Type G / Type F		line voltage-dependent, 10 ms delay 3 kA (8/20µs), surge current-proof
Rated voltage	U_n	240 V AC, 50 Hz
Rated operational voltage	U_e	204-260 V AC
Voltage range test circuit		195-264 V AC
Rated tripping current	$I_{\Delta n}$	10, 30, 100 mA
Rated non-tripping current	$I_{\Delta no}$	0.55 $I_{\Delta n}$
Sensitivity		AC and pulsating DC, Type F according to IEC 62423
Press of test button duration		> 0.5 s
Selectivity class		3
Service short circuit capacity	I_{cs}	7.5 kA
Rated short circuit capacity	I_{cn}	10 kA
Rated current		6 - 25 A
Rated impulse withstand voltage	U_{imp}	4 kV (1.2/50µs)
Characteristic		B, C, D
Maximum back-up fuse (short circuit protection)		100 A gL (>10 kA)
Endurance		
electrical components		≥ 4,000 operating cycles ($I_n, U_n, \cos\phi = 0.87$)
mechanical components		≥ 10,000 operating cycles
Mechanical		
Frame size		45 mm
Device height		80 mm
Device width		35 mm (2MU)
Mounting		3-position DIN rail clip, permits removal from existing busbar system
Degree of protection switch		IP20
Degree of protection, built-in		IP40
Upper and lower terminals		open mouthed/lift terminals
Terminal protection		finger and hand touch safe, DGUV VS3, EN 50274
Terminal capacity		1 - 25 mm ²
Terminal screw		M5 (with slotted screw acc. to EN ISO 4757-Z2, Pozidriv PZ2)
Terminal torque		2 - 2.4 Nm
Busbar thickness		0.8 - 2 mm
Operation temperature		-25°C to +40°C
Storage- and transport temperature		-35°C to +60°C
Resistance to climatic conditions		acc. to IEC 68-2 (25..55°C / 90..95% RH)
Line side (supply)		lower terminals
Load side		upper terminals

Connection diagram

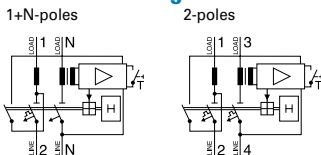

Dimensions (mm)

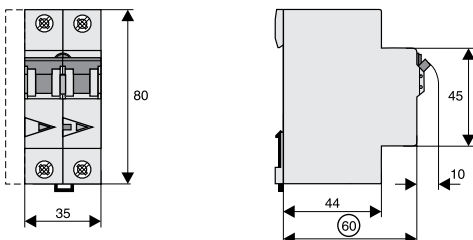

Tripping Characteristic FRBdM, Characteristics B, C and D

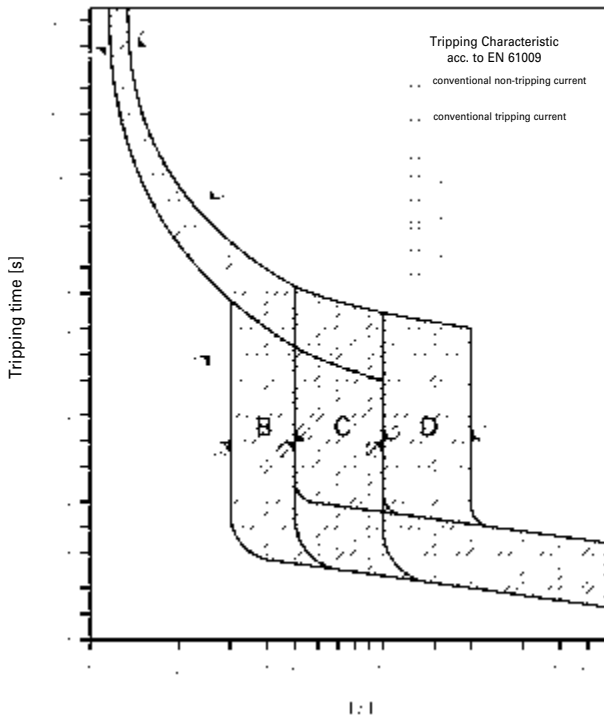

Internal Resistance FRBdM

Type B

At room temperature (single pole)

I_n [A]	R^* [m Ω]
10	17.9
13	12.3
16	7.6

* 50Hz

Type C

At room temperature (single pole)

I_n [A]	R^* [m Ω]
6	28.5
10	17.7
13	9.0
16	6.7
20	5.5
25	3.0

* 50Hz

Type D

At room temperature (single pole)

I_n [A]	R^* [m Ω]
6	28.5
10	14.9
13	9.0
16	6.7
20	5.5
25	3.0

* 50Hz

Power Loss at I_n FRBdM

Type B

(entire unit)

I_n [A]	P^* [W]
10	4.0
13	4.9
16	4.5

* 50Hz and ambient temperature

Type C

(entire unit)

I_n [A]	P^* [W]
6	2.1
10	4.0
13	3.4
16	3.9
20	5.0
25	4.2

* 50Hz and ambient temperature

Type D

(entire unit)

I_n [A]	P^* [W]
6	2.1
10	3.2
13	3.4
16	3.9
20	5.0
25	4.2

* 50Hz and ambient temperature

Let-through Energy FRBdM

Let-through Energy FRBdM, Characteristic B

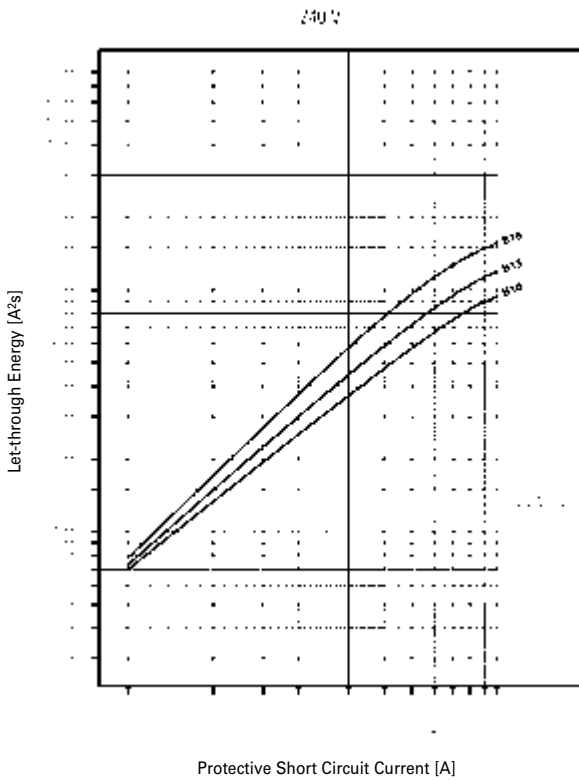

Let-through Energy FRBdM, Characteristic C

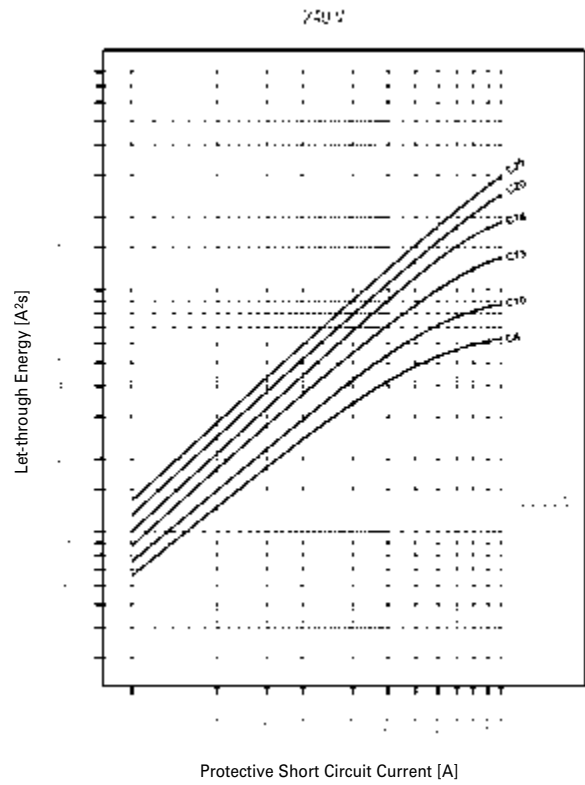

Let-through Energy FRBdM, Characteristic D

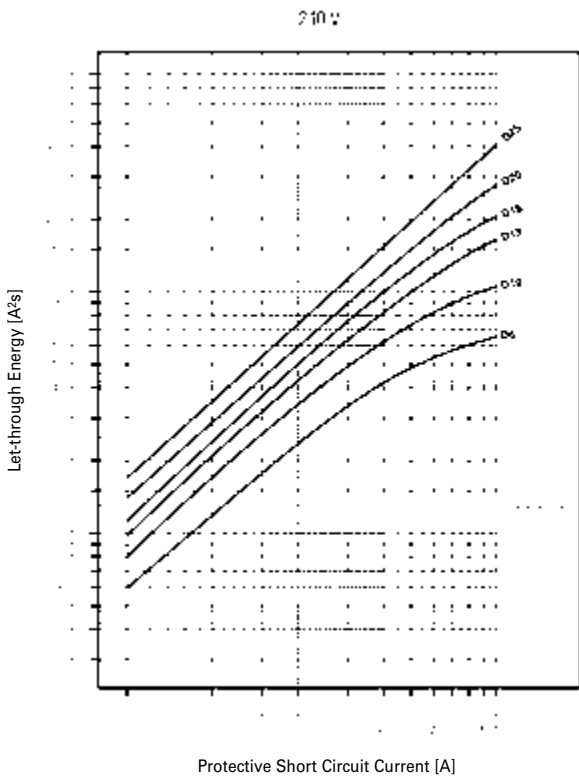

Let-through Current FRBdM

Let-through Current FRBdM, Characteristic B

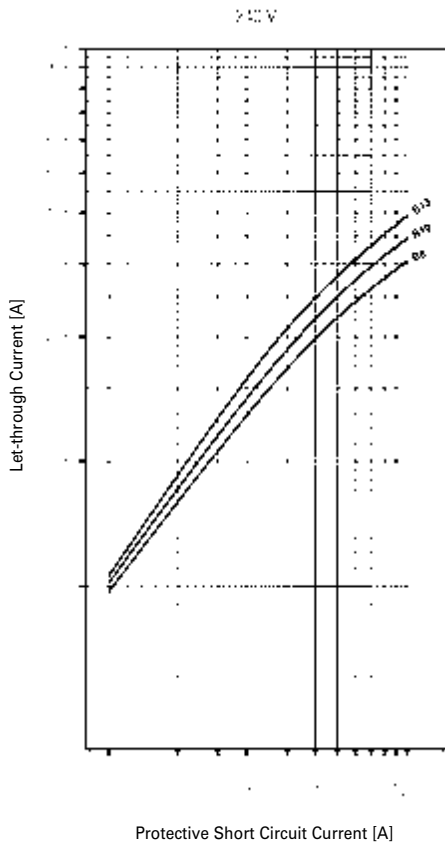

Let-through Current FRBdM, Characteristic C

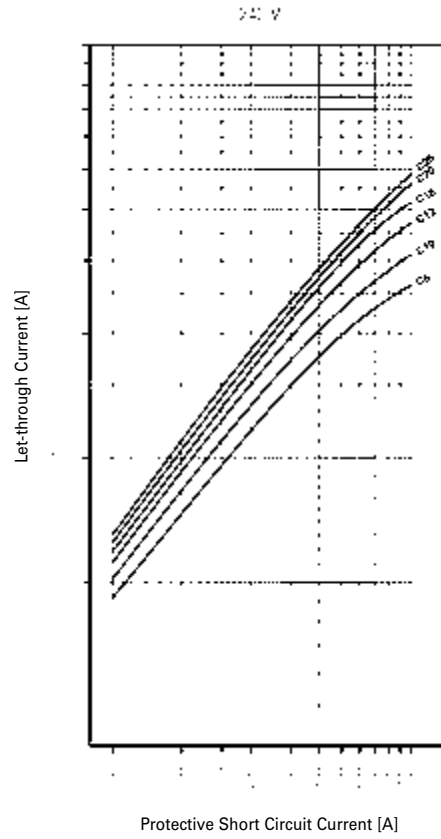

Let-through Current FRBdM, Characteristic D

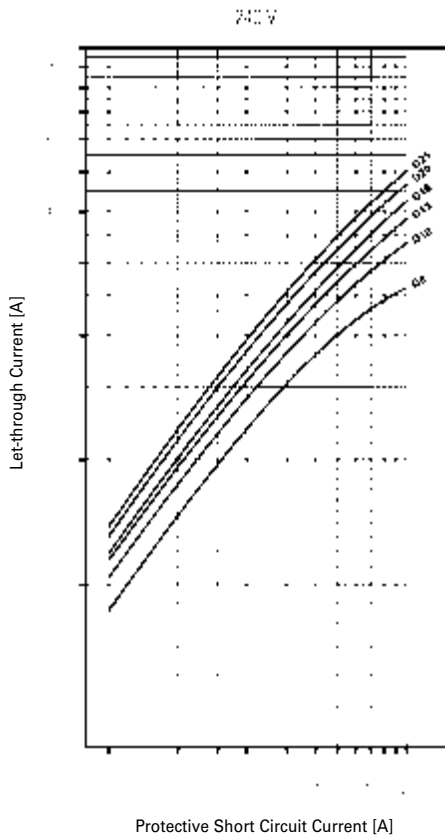

Short-circuit Selectivity FRBdM

In case of a short-circuit, selectivity is provided up to the specified selective current values I_s (kA) applicable between the FRBdM RCD/MCB circuit breakers and the up-stream protective devices.

When a short-circuit occurs, this means that with I_{KS} current values below I_s only the MCB will trip. However, in case of short-circuit currents beyond these values both protective devices will trip.

FRBdM and NZMB(C)(N)(H)1-A..., NZMB(C)(N)(H)2-A...

Short circuit currents in kA, rated currents of fuses in A.

Overload and short-circuit release unit NZM at max. value

FRBdM	NZM.1-A...						FRBdM	NZM.2-A...								
	$I_{cu} = 25 (36) (50) (100) \text{ kA}$							$I_{cu} = 25 (36) (50) (150) \text{ kA}$								
	40	50	63	80	100	125		40	50	63	80	100	125	160	200	250
B10	1.2	1.5	2	2	4	10	B10	1	1.5	2.5	3	10	10	10	10	10
B13	1	1.5	2	2	4	10	B13	1	1.2	2	3	10	10	10	10	10
B16	1	1.2	1.5	2	3	8	B16	1	1.2	1.5	2.5	10	10	10	10	10
C+D6	1.2	1.5	2	2	4	10	C+D6	1	1.5	2.5	3	10	10	10	10	10
C+D10	1.2	1.5	2	2	4	10	C+D10	1	1.5	2.5	3	10	10	10	10	10
C+D13	1	1.5	2	2	4	10	C+D13	1	1.2	2	3	10	10	10	10	10
C+D16	1	1.2	1.5	2	3	8	C+D16	1	1.2	1.5	2.5	10	10	10	10	10
C+D20	0.8	1.2	1.5	1.5	3	8	C+D20	1	1.2	1.5	1.5	10	10	10	10	10
C+D25	0.7	1.1	1.3	1.3	2.5	6	C+D25	0.9	1.1	1.3	1.3	10	10	10	10	10

NZMB1(C1)(N1)(H1): $I_{cu} (400/415V) = 25(36)(50)(100) \text{ kA}$ (acc. to IEC/EN 60947-2)

NZMB2(C2)(N2)(H2): $I_{cu} (400/415V) = 25(36)(50)(150) \text{ kA}$ (acc. to IEC/EN 60947-2)

FRBdM and NH000/NH00/NH1 gG

Short circuit currents in kA, rated currents of fuses in A.

FRBdM	NH000/NH00/NH1 gG										
	16	20	25	32	35	40	50	63	80	100	125
B10	<0.5	<0.5	0,9	1,7	2,3	3,4	5,2	6,9	>10	>10	>10
B13	<0.5	<0.5	0,8	1,4	1,9	2,7	4,1	5,2	8,5	>10	>10
B16	<0.5	<0.5	0,7	1,2	1,6	2,2	3,1	3,8	5,7	>10	>10
C6	<0.5	0,5	0,9	1,8	2,5	3,8	8,2	>10	>10	>10	>10
C10	<0.5	<0.5	0,8	1,5	2,0	2,9	4,5	6,6	>10	>10	>10
C13	<0.5	<0.5	0,6	1,2	1,5	2,2	3,3	4,2	6,7	>10	>10
C16	<0.5	<0.5	0,6	1,0	1,3	1,8	2,6	3,3	4,8	>10	>10
C20	<0.5	<0.5	0,5	0,9	1,1	1,6	2,3	2,8	4,1	8,6	>10
C25	<0.5	<0.5	<0.5	0,8	1,0	1,4	2,0	2,5	3,6	7,1	>10
D6	<0.5	0,5	1,0	1,8	2,5	3,8	7,8	>10	>10	>10	>10
D10	<0.5	<0.5	0,7	1,2	1,6	2,4	3,8	5,2	>10	>10	>10
D13	<0.5	<0.5	0,6	1,0	1,3	1,9	2,8	3,6	5,6	>10	>10
D16	<0.5	<0.5	0,5	0,9	1,1	1,6	2,3	2,9	4,3	>10	>10
D20	<0.5	<0.5	<0.5	0,8	1,0	1,4	2,0	2,5	3,6	7,5	>10
D25	<0.5	<0.5	<0.5	0,7	0,8	1,1	1,6	2,1	3,1	5,5	7,7

Rated breaking capacity (NH) AC 500 V = 120 kA (acc. to IEC/EN 60269)

FRBdM and PLSM-OV/PLHT-OV..

Short circuit currents in kA, rated currents of fuses in A.

FRBdM	PLSM-OV/PLHT-OV						
	$I_{cu} = 10 \text{ kA}$						
	25	32	40	50	56	63	80
B10	1.5	1.5	1.5	1.5	1.5	1.5	1.5
B13	1.5	1.5	1.5	1.5	1.5	1.5	1.5
B16	1.5	1.5	1.5	1.5	1.5	1.5	1.5
C+D6	1.5	1.5	1.5	1.5	1.5	1.5	1.5
C+D10	1.5	1.5	1.5	1.5	1.5	1.5	1.5
C+D13	1.5	1.5	1.5	1.5	1.5	1.5	1.5
C+D16	1.5	1.5	1.5	1.5	1.5	1.5	1.5
C+D20	-	1.5	1.5	1.5	1.5	1.5	1.5
C+D25	-	-	1.5	1.5	1.5	1.5	1.5

Back-up Protection FRBdM

The up-stream protective devices will protect the down-stream FRBdM up to the short-circuit current specified.

FRBdM and NZM1.1-A..., 240 V

Short circuit currents in kA.

FRBdM	NZMB1-A...		
	U _e = 240 V		
	B	C	D
6	-	25	25
10	25	25	25
13	25	25	25
16	25	25	25
20	-	20	20
25	-	20	20

U_e = 240V: I_{cn} (FRBdM) = 10 kA (acc. to IEC/EN 61009)

U_e = 400/415V: I_{cu} (NZMB1) = 25 kA (acc. to IEC/EN 60947-2)

Short circuit currents in kA.

FRBdM	NZMN1-A...		
	U _e = 240 V		
	B	C	D
6	-	40	40
10	40	40	40
13	40	40	40
16	40	40	40
20	-	20	20
25	-	20	20

U_e = 240V: I_{cn} (FRBdM) = 10 kA (acc. to IEC/EN 61009)

U_e = 400/415V: I_{cu} (NZMN1) = 50 kA (acc. to IEC/EN 60947-2)

Short circuit currents in kA.

FRBdM	NZMC1-A...		
	U _e = 240 V		
	B	C	D
6	-	36	36
10	36	36	36
13	36	36	36
16	36	36	36
20	-	20	20
25	-	20	20

U_e = 240V: I_{cn} (FRBdM) = 10 kA (acc. to IEC/EN 61009)

U_e = 400/415V: I_{cu} (NZMC1) = 36 kA (acc. to IEC/EN 60947-2)

Short circuit currents in kA.

FRBdM	NZMH1-A...		
	U _e = 240 V		
	B	C	D
6	-	40	40
10	40	40	40
13	40	40	40
16	40	40	40
20	-	20	20
25	-	20	20

U_e = 240V: I_{cn} (FRBdM) = 10 kA (acc. to IEC/EN 61009)

U_e = 400/415V: I_{cu} (NZMH1) = 100 kA (acc. to IEC/EN 60947-2)

FRBdM and NZM2-A..., 240 V

Short circuit currents in kA.

FRBdM	NZMB2-A...		
	U _e = 240 V		
	B	C	D
6	-	25	25
10	25	25	25
13	25	25	25
16	25	25	25
20	-	20	20
25	-	10	10

U_e = 240V: I_{cn} (FRBdM) = 10 kA (acc. to IEC/EN 61009)

U_e = 400/415V: I_{cu} (NZMB2) = 25 kA (acc. to IEC/EN 60947-2)

Short circuit currents in kA.

FRBdM	NZMN2-A...		
	U _e = 240 V		
	B	C	D
6	-	40	40
10	40	40	40
13	40	40	40
16	25	25	25
20	-	15	15
25	-	10	10

U_e = 240V: I_{cn} (FRBdM) = 10 kA (acc. to IEC/EN 61009)

U_e = 400/415V: I_{cu} (NZMN2) = 50 kA (acc. to IEC/EN 60947-2)

Short circuit currents in kA.

FRBdM	NZMC2-A...		
	U _e = 240 V		
	B	C	D
6	-	36	36
10	36	36	36
13	36	36	36
16	25	25	25
20	-	20	20
25	-	10	10

U_e = 240V: I_{cn} (FRBdM) = 10 kA (acc. to IEC/EN 61009)

U_e = 400/415V: I_{cu} (NZMC2) = 36 kA (acc. to IEC/EN 60947-2)

Short circuit currents in kA.

FRBdM	NZMH2-A...		
	U _e = 240 V		
	B	C	D
6	-	40	40
10	40	40	40
13	40	40	40
16	25	25	25
20	-	15	15
25	-	10	10

U_e = 240V: I_{cn} (FRBdM) = 10 kA (acc. to IEC/EN 61009)

U_e = 400/415V: I_{cu} (NZMH2) = 150 kA (acc. to IEC/EN 60947-2)

FRBdM and NH00-125 A, 240 V

Short circuit currents in kA.

FRBdM	NH00-125A gG		
	U _e = 240 V		
	B	C	D
6	-	40	40
10	40	40	40
13	40	40	40
16	40	40	40
20	-	20	20
25	-	10	10

U_e = 240V: I_{cn} (FRBdM) = 10 kA (acc. to IEC/EN 61009)

AC 500 V (NH00-125A gG) = 120 kA (acc. to IEC/EN 60269)

FRBdM and PLSM-OV63, 230 V

Short circuit currents in kA.

FRBdM	PLSM-OV63/2, 3, 4, 3N		
	IT-system U = 230 V		
	B	C	D
6	-	10	10
10	10	10	10
13	10	10	10
16	10	10	10
20	-	10	10
25	-	10	10

U_e = 240V: I_{cn} (FRBdM) = 10 kA (acc. to IEC/EN 61009)

U_e = 230/400V: I_{cu} (PLSM-OV63) = 10 kA (acc. to IEC/EN 60947-2)

SG03013



Description

- High-quality residual current device / miniature circuit breaker combination, line voltage-independent
- Increased protection in applications with 1-phase frequency converter due to the detection of mixed frequencies (type F)
- Reduction of nuisance tripping (type F, G, or G/A) thanks to
 - time delayed tripping
 - increased current withstand capability >3 kA
- Higher load rating with DC residual currents up to 10 mA (type F)
- Contact position indicator red - green
- Fault current tripping indicator
- Guide for secure terminal connection
- 3-position DIN rail clip, permits removal from existing busbar system
- Comprehensive range of accessories suitable for subsequent installation
- Wide variety of rated tripping currents
- Rated currents up to 40 A
- Tripping characteristics B, C, D
- Rated breaking capacity acc. to IEC/EN 61009 10 kA
- Rated breaking capacity acc. to IEC/EN 60947-2 up to 15 kA
- Classified for the use in rail rolling stock

$I_n/I_{\Delta n}$
(A)

Type
Designation

Article No. Units per
package

Type F

10 kA, 1+N-poles

Selective + surge current-proof 3 kA, sensitive to residual pulsating DC, Type F 

SG63013



Characteristic B

13/003	FRBmM-B13/1N/003-F	193479	1/60
16/003	FRBmM-B16/1N/003-F	193480	1/60
20/003	FRBmM-B20/1N/003-F	193481	1/60
25/003	FRBmM-B25/1N/003-F	193488	1/60
32/003	FRBmM-B32/1N/003-F	193489	1/60
40/003	FRBmM-B40/1N/003-F	193490	1/60
13/03	FRBmM-B13/1N/03-F	193494	1/60
16/03	FRBmM-B16/1N/03-F	193495	1/60
20/03	FRBmM-B20/1N/03-F	193496	1/60
25/03	FRBmM-B25/1N/03-F	193503	1/60
32/03	FRBmM-B32/1N/03-F	193504	1/60
40/03	FRBmM-B40/1N/03-F	193505	1/60
13/01	FRBmM-B13/1N/01-F	193509	1/60
16/01	FRBmM-B16/1N/01-F	193510	1/60
20/01	FRBmM-B20/1N/01-F	193514	1/60
25/01	FRBmM-B25/1N/01-F	193521	1/60
32/01	FRBmM-B32/1N/01-F	193522	1/60
40/01	FRBmM-B40/1N/01-F	193523	1/60

SG63013



Characteristic C

13/003	FRBmM-C13/1N/003-F	193482	1/60
16/003	FRBmM-C16/1N/003-F	193483	1/60
20/003	FRBmM-C20/1N/003-F	193484	1/60
25/003	FRBmM-C25/1N/003-F	193491	1/60
32/003	FRBmM-C32/1N/003-F	193492	1/60
40/003	FRBmM-C40/1N/003-F	193493	1/60
13/03	FRBmM-C13/1N/03-F	193497	1/60
16/03	FRBmM-C16/1N/03-F	193498	1/60
20/03	FRBmM-C20/1N/03-F	193499	1/60
25/03	FRBmM-C25/1N/03-F	193506	1/60
32/03	FRBmM-C32/1N/03-F	193507	1/60
40/03	FRBmM-C40/1N/03-F	193508	1/60
13/01	FRBmM-C13/1N/01-F	193515	1/60
16/01	FRBmM-C16/1N/01-F	193516	1/60
20/01	FRBmM-C20/1N/01-F	193517	1/60
25/01	FRBmM-C25/1N/01-F	193524	1/60
32/01	FRBmM-C32/1N/01-F	193525	1/60
40/01	FRBmM-C40/1N/01-F	193526	1/60

SG03013

**Characteristic D**

13/003	FRBmM-D13/1N/003-F	193485	1/60
16/003	FRBmM-D16/1N/003-F	193486	1/60
20/003	FRBmM-D20/1N/003-F	193487	1/60
13/03	FRBmM-D13/1N/03-F	193500	1/60
16/03	FRBmM-D16/1N/03-F	193501	1/60
20/03	FRBmM-D20/1N/03-F	193502	1/60
13/01	FRBmM-D13/1N/01-F	193518	1/60
16/01	FRBmM-D16/1N/01-F	193519	1/60
20/01	FRBmM-D20/1N/01-F	193520	1/60

$I_n/I_{\Delta n}$ (A)	Type Designation	Article No.	Units per package
---------------------------	---------------------	-------------	----------------------

Type G/A

10 kA, 1+N-poles

Surge current-proof 3 kA, sensitive to residual pulsating DC, Type G/A (ÖVE E 8601) 

SG03013



Characteristic B

13/0.03	FRBmM-B13/1N/003-G/A	170716	1/60
16/0.03	FRBmM-B16/1N/003-G/A	170717	1/60
20/0.03	FRBmM-B20/1N/003-G/A	170528	1/60
25/0.03	FRBmM-B25/1N/003-G/A	170529	1/60
32/0.03	FRBmM-B32/1N/003-G/A	170530	1/60
40/0.03	FRBmM-B40/1N/003-G/A	170531	1/60

SG03013



Characteristic C

13/0.03	FRBmM-C13/1N/003-G/A	170630	1/60
16/0.03	FRBmM-C16/1N/003-G/A	170631	1/60
20/0.03	FRBmM-C20/1N/003-G/A	170632	1/60
25/0.03	FRBmM-C25/1N/003-G/A	170633	1/60
32/0.03	FRBmM-C32/1N/003-G/A	170634	1/60
40/0.03	FRBmM-C40/1N/003-G/A	170635	1/60

SG03013



Characteristic D

13/0.03	FRBmM-D13/1N/003-G/A	170653	1/60
16/0.03	FRBmM-D16/1N/003-G/A	170654	1/60
20/0.03	FRBmM-D20/1N/003-G/A	170655	1/60

$I_n/I_{\Delta n}$
(A)Type
Designation

Article No.

Units per
package**Type G****10 kA, 1+N-poles****Surge current-proof 3 kA, Type G (ÖVE E 8601)** 

SG03013

**Characteristic B**

13/0.03	FRBmM-B13/1N/003-G	170710	1/60
16/0.03	FRBmM-B16/1N/003-G	170711	1/60
20/0.03	FRBmM-B20/1N/003-G	170712	1/60
25/0.03	FRBmM-B25/1N/003-G	170713	1/60
32/0.03	FRBmM-B32/1N/003-G	170714	1/60
40/0.03	FRBmM-B40/1N/003-G	170715	1/60
13/0.3	FRBmM-B13/1N/03-G	170555	1/60
16/0.3	FRBmM-B16/1N/03-G	170556	1/60
20/0.3	FRBmM-B20/1N/03-G	170557	1/60
25/0.3	FRBmM-B25/1N/03-G	170558	1/60
32/0.3	FRBmM-B32/1N/03-G	170559	1/60
40/0.3	FRBmM-B40/1N/03-G	170560	1/60

SG03013

**Characteristic C**

13/0.03	FRBmM-C13/1N/003-G	170624	1/60
16/0.03	FRBmM-C16/1N/003-G	170625	1/60
20/0.03	FRBmM-C20/1N/003-G	170626	1/60
25/0.03	FRBmM-C25/1N/003-G	170627	1/60
32/0.03	FRBmM-C32/1N/003-G	170628	1/60
40/0.03	FRBmM-C40/1N/003-G	170629	1/60
13/0.3	FRBmM-C13/1N/03-G	170581	1/60
16/0.3	FRBmM-C16/1N/03-G	170582	1/60
20/0.3	FRBmM-C20/1N/03-G	170583	1/60
25/0.3	FRBmM-C25/1N/03-G	170584	1/60
32/0.3	FRBmM-C32/1N/03-G	170585	1/60
40/0.3	FRBmM-C40/1N/03-G	170586	1/60

SG03013

**Characteristic D**

13/0.03	FRBmM-D13/1N/003-G	170650	1/60
16/0.03	FRBmM-D16/1N/003-G	170651	1/60
20/0.03	FRBmM-D20/1N/003-G	170652	1/60
13/0.3	FRBmM-D13/1N/03-G	170869	1/60
16/0.3	FRBmM-D16/1N/03-G	170870	1/60
20/0.3	FRBmM-D20/1N/03-G	170871	1/60

$I_n/I_{\Delta n}$
(A)

Type
Designation

Article No.

Units per
package

Type A

10 kA, 1+N-poles

bedingt surge current-proof 250A, pulsstromsensitiv, Type A 

SG03013



Characteristic B

6/0.01	FRBmM-B6/1N/001-A	170975	1/60
10/0.01	FRBmM-B10/1N/001-A	170976	1/60
13/0.01	FRBmM-B13/1N/001-A	170977	1/60
16/0.01	FRBmM-B16/1N/001-A	170978	1/60
6/0.03	FRBmM-B6/1N/003-A	170702	1/60
10/0.03	FRBmM-B10/1N/003-A	170703	1/60
13/0.03	FRBmM-B13/1N/003-A	170704	1/60
16/0.03	FRBmM-B16/1N/003-A	170705	1/60
20/0.03	FRBmM-B20/1N/003-A	170706	1/60
25/0.03	FRBmM-B25/1N/003-A	170707	1/60
32/0.03	FRBmM-B32/1N/003-A	170708	1/60
40/0.03	FRBmM-B40/1N/003-A	170709	1/60
6/0.1	FRBmM-B6/1N/01-A	170664	1/60
10/0.1	FRBmM-B10/1N/01-A	170665	1/60
13/0.1	FRBmM-B13/1N/01-A	170666	1/60
16/0.1	FRBmM-B16/1N/01-A	170667	1/60
20/0.1	FRBmM-B20/1N/01-A	170668	1/60
25/0.1	FRBmM-B25/1N/01-A	170669	1/60
32/0.1	FRBmM-B32/1N/01-A	170670	1/60
40/0.1	FRBmM-B40/1N/01-A	170671	1/60
6/0.3	FRBmM-B6/1N/03-A	170607	1/60
10/0.3	FRBmM-B10/1N/03-A	170608	1/60
13/0.3	FRBmM-B13/1N/03-A	170609	1/60
16/0.3	FRBmM-B16/1N/03-A	170610	1/60
20/0.3	FRBmM-B20/1N/03-A	170611	1/60
25/0.3	FRBmM-B25/1N/03-A	170552	1/60
32/0.3	FRBmM-B32/1N/03-A	170553	1/60
40/0.3	FRBmM-B40/1N/03-A	170554	1/60

SG03013



Characteristic C

2/0.01	FRBmM-C2/1N/001-A	170904	1/60
4/0.01	FRBmM-C4/1N/001-A	170905	1/60
6/0.01	FRBmM-C6/1N/001-A	170906	1/60
10/0.01	FRBmM-C10/1N/001-A	170907	1/60
13/0.01	FRBmM-C13/1N/001-A	170908	1/60
16/0.01	FRBmM-C16/1N/001-A	170921	1/60
2/0.03	FRBmM-C2/1N/003-A	170614	1/60
4/0.03	FRBmM-C4/1N/003-A	170615	1/60
6/0.03	FRBmM-C6/1N/003-A	170616	1/60
10/0.03	FRBmM-C10/1N/003-A	170617	1/60
13/0.03	FRBmM-C13/1N/003-A	170618	1/60
16/0.03	FRBmM-C16/1N/003-A	170619	1/60
20/0.03	FRBmM-C20/1N/003-A	170620	1/60
25/0.03	FRBmM-C25/1N/003-A	170621	1/60
32/0.03	FRBmM-C32/1N/003-A	170622	1/60
40/0.03	FRBmM-C40/1N/003-A	170623	1/60
2/0.1	FRBmM-C2/1N/01-A	170682	1/60
4/0.1	FRBmM-C4/1N/01-A	170683	1/60
6/0.1	FRBmM-C6/1N/01-A	170684	1/60
10/0.1	FRBmM-C10/1N/01-A	170685	1/60
13/0.1	FRBmM-C13/1N/01-A	170686	1/60
16/0.1	FRBmM-C16/1N/01-A	170687	1/60
20/0.1	FRBmM-C20/1N/01-A	170688	1/60
25/0.1	FRBmM-C25/1N/01-A	170689	1/60
32/0.1	FRBmM-C32/1N/01-A	170690	1/60
40/0.1	FRBmM-C40/1N/01-A	170691	1/60
2/0.3	FRBmM-C2/1N/03-A	170571	1/60
4/0.3	FRBmM-C4/1N/03-A	170572	1/60
6/0.3	FRBmM-C6/1N/03-A	170573	1/60
10/0.3	FRBmM-C10/1N/03-A	170574	1/60
13/0.3	FRBmM-C13/1N/03-A	170575	1/60
16/0.3	FRBmM-C16/1N/03-A	170576	1/60
20/0.3	FRBmM-C20/1N/03-A	170577	1/60
25/0.3	FRBmM-C25/1N/03-A	170578	1/60
32/0.3	FRBmM-C32/1N/03-A	170579	1/60
40/0.3	FRBmM-C40/1N/03-A	170580	1/60

SG03013

**Characteristic D**

2/0.01	FRBmM-D2/1N/001-A	170914	1/60
4/0.01	FRBmM-D4/1N/001-A	170915	1/60
6/0.01	FRBmM-D6/1N/001-A	170916	1/60
10/0.01	FRBmM-D10/1N/001-A	170917	1/60
13/0.01	FRBmM-D13/1N/001-A	170918	1/60
16/0.01	FRBmM-D16/1N/001-A	170919	1/60
2/0.03	FRBmM-D2/1N/003-A	170643	1/60
4/0.03	FRBmM-D4/1N/003-A	170644	1/60
6/0.03	FRBmM-D6/1N/003-A	170645	1/60
10/0.03	FRBmM-D10/1N/003-A	170646	1/60
13/0.03	FRBmM-D13/1N/003-A	170647	1/60
16/0.03	FRBmM-D16/1N/003-A	170648	1/60
20/0.03	FRBmM-D20/1N/003-A	170649	1/60
2/0.1	FRBmM-D2/1N/01-A	170544	1/60
4/0.1	FRBmM-D4/1N/01-A	170545	1/60
6/0.1	FRBmM-D6/1N/01-A	170546	1/60
10/0.1	FRBmM-D10/1N/01-A	170547	1/60
13/0.1	FRBmM-D13/1N/01-A	170548	1/60
16/0.1	FRBmM-D16/1N/01-A	170549	1/60
20/0.1	FRBmM-D20/1N/01-A	170550	1/60
2/0.3	FRBmM-D2/1N/03-A	170594	1/60
4/0.3	FRBmM-D4/1N/03-A	170595	1/60
6/0.3	FRBmM-D6/1N/03-A	170596	1/60
10/0.3	FRBmM-D10/1N/03-A	170597	1/60
13/0.3	FRBmM-D13/1N/03-A	170598	1/60
16/0.3	FRBmM-D16/1N/03-A	170599	1/60
20/0.3	FRBmM-D20/1N/03-A	170868	1/60

$I_n/I_{\Delta n}$
(A)

Type
Designation

Article No.

Units per
package

Type AC

10 kA, 1+N-poles

Conditionally surge current-proof 250 A, Type AC 

SG03013



Characteristic B

6/0.01	FRBmM-B6/1N/001	170971	1/60
10/0.01	FRBmM-B10/1N/001	170972	1/60
13/0.01	FRBmM-B13/1N/001	170973	1/60
16/0.01	FRBmM-B16/1N/001	170974	1/60
6/0.03	FRBmM-B6/1N/003	170920	1/60
10/0.03	FRBmM-B10/1N/003	170695	1/60
13/0.03	FRBmM-B13/1N/003	170696	1/60
16/0.03	FRBmM-B16/1N/003	170697	1/60
20/0.03	FRBmM-B20/1N/003	170698	1/60
25/0.03	FRBmM-B25/1N/003	170699	1/60
32/0.03	FRBmM-B32/1N/003	170700	1/60
40/0.03	FRBmM-B40/1N/003	170701	1/60
6/0.1	FRBmM-B6/1N/01	170656	1/60
10/0.1	FRBmM-B10/1N/01	170657	1/60
13/0.1	FRBmM-B13/1N/01	170658	1/60
16/0.1	FRBmM-B16/1N/01	170659	1/60
20/0.1	FRBmM-B20/1N/01	170660	1/60
25/0.1	FRBmM-B25/1N/01	170661	1/60
32/0.1	FRBmM-B32/1N/01	170662	1/60
40/0.1	FRBmM-B40/1N/01	170663	1/60
6/0.3	FRBmM-B6/1N/03	170551	1/60
10/0.3	FRBmM-B10/1N/03	170600	1/60
13/0.3	FRBmM-B13/1N/03	170601	1/60
16/0.3	FRBmM-B16/1N/03	170602	1/60
20/0.3	FRBmM-B20/1N/03	170603	1/60
25/0.3	FRBmM-B25/1N/03	170604	1/60
32/0.3	FRBmM-B32/1N/03	170605	1/60
40/0.3	FRBmM-B40/1N/03	170606	1/60

SG03013



Characteristic C

2/0.01	FRBmM-C2/1N/001	170979	1/60
4/0.01	FRBmM-C4/1N/001	170980	1/60
6/0.01	FRBmM-C6/1N/001	170981	1/60
10/0.01	FRBmM-C10/1N/001	170982	1/60
13/0.01	FRBmM-C13/1N/001	170983	1/60
16/0.01	FRBmM-C16/1N/001	170984	1/60
2/0.03	FRBmM-C2/1N/003	170532	1/60
4/0.03	FRBmM-C4/1N/003	170533	1/60
6/0.03	FRBmM-C6/1N/003	170534	1/60
10/0.03	FRBmM-C10/1N/003	170535	1/60
13/0.03	FRBmM-C13/1N/003	170536	1/60
16/0.03	FRBmM-C16/1N/003	170537	1/60
20/0.03	FRBmM-C20/1N/003	170538	1/60
25/0.03	FRBmM-C25/1N/003	170539	1/60
32/0.03	FRBmM-C32/1N/003	170612	1/60
40/0.03	FRBmM-C40/1N/003	170613	1/60
2/0.1	FRBmM-C2/1N/01	170672	1/60
4/0.1	FRBmM-C4/1N/01	170673	1/60
6/0.1	FRBmM-C6/1N/01	170674	1/60
10/0.1	FRBmM-C10/1N/01	170675	1/60
13/0.1	FRBmM-C13/1N/01	170676	1/60
16/0.1	FRBmM-C16/1N/01	170677	1/60
20/0.1	FRBmM-C20/1N/01	170678	1/60
25/0.1	FRBmM-C25/1N/01	170679	1/60
32/0.1	FRBmM-C32/1N/01	170680	1/60
40/0.1	FRBmM-C40/1N/01	170681	1/60
2/0.3	FRBmM-C2/1N/03	170561	1/60
4/0.3	FRBmM-C4/1N/03	170562	1/60
6/0.3	FRBmM-C6/1N/03	170563	1/60
10/0.3	FRBmM-C10/1N/03	170564	1/60
13/0.3	FRBmM-C13/1N/03	170565	1/60
16/0.3	FRBmM-C16/1N/03	170566	1/60
20/0.3	FRBmM-C20/1N/03	170567	1/60
25/0.3	FRBmM-C25/1N/03	170568	1/60
32/0.3	FRBmM-C32/1N/03	170569	1/60
40/0.3	FRBmM-C40/1N/03	170570	1/60

SG03013

**Characteristic D**

2/0.01	FRBmM-D2/1N/001	170922	1/60
4/0.01	FRBmM-D4/1N/001	170909	1/60
6/0.01	FRBmM-D6/1N/001	170910	1/60
10/0.01	FRBmM-D10/1N/001	170911	1/60
13/0.01	FRBmM-D13/1N/001	170912	1/60
16/0.01	FRBmM-D16/1N/001	170913	1/60
2/0.03	FRBmM-D2/1N/003	170636	1/60
4/0.03	FRBmM-D4/1N/003	170637	1/60
6/0.03	FRBmM-D6/1N/003	170638	1/60
10/0.03	FRBmM-D10/1N/003	170639	1/60
13/0.03	FRBmM-D13/1N/003	170640	1/60
16/0.03	FRBmM-D16/1N/003	170641	1/60
20/0.03	FRBmM-D20/1N/003	170642	1/60
2/0.1	FRBmM-D2/1N/01	170692	1/60
4/0.1	FRBmM-D4/1N/01	170693	1/60
6/0.1	FRBmM-D6/1N/01	170694	1/60
10/0.1	FRBmM-D10/1N/01	170540	1/60
13/0.1	FRBmM-D13/1N/01	170541	1/60
16/0.1	FRBmM-D16/1N/01	170542	1/60
20/0.1	FRBmM-D20/1N/01	170543	1/60
2/0.3	FRBmM-D2/1N/03	170587	1/60
4/0.3	FRBmM-D4/1N/03	170588	1/60
6/0.3	FRBmM-D6/1N/03	170589	1/60
10/0.3	FRBmM-D10/1N/03	170590	1/60
13/0.3	FRBmM-D13/1N/03	170591	1/60
16/0.3	FRBmM-D16/1N/03	170592	1/60
20/0.3	FRBmM-D20/1N/03	170593	1/60

Type G/A**6 kA, 1+N-poles****Surge current-proof 3 kA, sensitive to residual pulsating DC, Type G/A (ÖVE E 8601)** 

SG03013

**Characteristic B**

13/003	FRBm6-B13/1N/003-G/A	177847	1/60
16/003	FRBm6-B16/1N/003-G/A	177848	1/60
20/003	FRBm6-B20/1N/003-G/A	177849	1/60
25/003	FRBm6-B25/1N/003-G/A	177850	1/60
32/003	FRBm6-B32/1N/003-G/A	177851	1/60
40/003	FRBm6-B40/1N/003-G/A	177852	1/60

SG03013

**Characteristic C**

13/003	FRBm6-C13/1N/003-G/A	177853	1/60
16/003	FRBm6-C16/1N/003-G/A	177854	1/60
20/003	FRBm6-C20/1N/003-G/A	177855	1/60
25/003	FRBm6-C25/1N/003-G/A	177856	1/60
32/003	FRBm6-C32/1N/003-G/A	177857	1/60
40/003	FRBm6-C40/1N/003-G/A	177858	1/60

SG03013

**Characteristic D**

13/003	FRBm6-D13/1N/003-G/A	177859	1/60
16/003	FRBm6-D16/1N/003-G/A	177860	1/60
20/003	FRBm6-D20/1N/003-G/A	177861	1/60

SG03013



Description

- A range of residual current device / miniature circuit breaker combination for a wide range of applications with the added benefit of accepting cables fitted with Ring Tongue connections - as used on applications such as Rail rolling stock etc.
- Line voltage independent
- Contact position indicator red - green
- Fault current tripping indicator
- Guide for secure terminal connection
- 3-position DIN rail clip, permits removal from existing busbar system
- Comprehensive range of accessories suitable for subsequent installation
- Wide variety of rated tripping currents
- Rated currents up to 40 A
- Tripping characteristics B, C, D
- Rated breaking capacity acc. to IEC/EN 61009 10 kA
- Rated breaking capacity acc. to IEC/EN 60947-2 up to 15 kA
- Classified for the use in rail rolling stock

$I_n/I_{\Delta n}$ (A)	Type Designation	Article No.	Units per package
---------------------------	---------------------	-------------	----------------------

Type A

10 kA, 1+N-poles

Conditionally surge current-proof 250 A, sensitive to residual pulsating DC, Type A

SG03013



Characteristic B

2/03	FRBMM-B2/1N/03-A-RT	305112	1/60
4/03	FRBMM-B4/1N/03-A-RT	305113	1/60
6/03	FRBMM-B6/1N/03-A-RT	305114	1/60
10/03	FRBMM-B10/1N/03-A-RT	305115	1/60
13/03	FRBMM-B13/1N/03-A-RT	305116	1/60
16/03	FRBMM-B16/1N/03-A-RT	305121	1/60
20/03	FRBMM-B20/1N/03-A-RT	305122	1/60
25/03	FRBMM-B25/1N/03-A-RT	305123	1/60
32/03	FRBMM-B32/1N/03-A-RT	305124	1/60
40/03	FRBMM-B40/1N/03-A-RT	305125	1/60
2/03	FRBMM-B2/1N/03-A-RT	305171	1/60
4/03	FRBMM-B4/1N/03-A-RT	305172	1/60
6/03	FRBMM-B6/1N/03-A-RT	305173	1/60
10/03	FRBMM-B10/1N/03-A-RT	305174	1/60
13/03	FRBMM-B13/1N/03-A-RT	305175	1/60
16/03	FRBMM-B16/1N/03-A-RT	305176	1/60
20/03	FRBMM-B20/1N/03-A-RT	305177	1/60
25/03	FRBMM-B25/1N/03-A-RT	305178	1/60
32/03	FRBMM-B32/1N/03-A-RT	305179	1/60
40/03	FRBMM-B40/1N/03-A-RT	305180	1/60

SG03013



Characteristic C

2/03	FRBMM-C2/1N/003-A-RT	305126	1/60
4/03	FRBMM-C4/1N/003-A-RT	305129	1/60
6/03	FRBMM-C6/1N/003-A-RT	305130	1/60
10/03	FRBMM-C10/1N/003-A-RT	305131	1/60
13/03	FRBMM-C13/1N/003-A-RT	305132	1/60
16/03	FRBMM-C16/1N/003-A-RT	305135	1/60
20/03	FRBMM-C20/1N/003-A-RT	305137	1/60
25/03	FRBMM-C25/1N/003-A-RT	305138	1/60
32/03	FRBMM-C32/1N/003-A-RT	305139	1/60
40/03	FRBMM-C40/1N/003-A-RT	305140	1/60
2/03	FRBMM-C2/1N/03-A-RT	305181	1/60
4/03	FRBMM-C4/1N/03-A-RT	305182	1/60
6/03	FRBMM-C6/1N/03-A-RT	305183	1/60
10/03	FRBMM-C10/1N/03-A-RT	305184	1/60
13/03	FRBMM-C13/1N/03-A-RT	305185	1/60
16/03	FRBMM-C16/1N/03-A-RT	305186	1/60
20/03	FRBMM-C20/1N/03-A-RT	305187	1/60
25/03	FRBMM-C25/1N/03-A-RT	305188	1/60
32/03	FRBMM-C32/1N/03-A-RT	305189	1/60
40/03	FRBMM-C40/1N/03-A-RT	305190	1/60

$I_n/I_{\Delta n}$ (A)	Type Designation	Article No.	Units per package
---------------------------	---------------------	-------------	----------------------

Type A

10 kA, 1+N-poles

Conditionally surge current-proof 250 A, sensitive to residual pulsating DC, Type A

SG03013



Characteristic D

2/03	FRBMM-D2/1N/003-A-RT	305141	1/60
4/03	FRBMM-D4/1N/003-A-RT	305143	1/60
6/03	FRBMM-D6/1N/003-A-RT	305144	1/60
10/03	FRBMM-D10/1N/003-A-RT	305146	1/60
13/03	FRBMM-D13/1N/003-A-RT	305147	1/60
16/03	FRBMM-D16/1N/003-A-RT	305148	1/60
20/03	FRBMM-D20/1N/003-A-RT	305149	1/60
2/03	FRBMM-D2/1N/03-A-RT	305192	1/60
4/03	FRBMM-D4/1N/03-A-RT	305193	1/60
6/03	FRBMM-D6/1N/03-A-RT	305194	1/60
10/03	FRBMM-D10/1N/03-A-RT	305195	1/60
13/03	FRBMM-D13/1N/03-A-RT	305196	1/60
16/03	FRBMM-D16/1N/03-A-RT	305197	1/60
20/03	FRBMM-D20/1N/03-A-RT	305198	1/60

Specifications | Combined RCD/MCB Devices FRBm., 1+N-poles

Description

- Combined RCD/MCB device
- Line voltage-independent tripping
- Compatible with standard busbar
- Twin-purpose terminal (lift/open-mouthed) above and below
- Busbar positioning optionally above or below
- Free terminal space despite installed busbar
- Guide for secure terminal connection
- Contact position indicator red - green
- Comprehensive range of accessories suitable for subsequent installation
- Nameplate
- The test key "T" must be pressed every 6 months. The system operator must be informed of this obligation and his responsibility in a way that can be proven. Under special conditions (e.g. damply and/or dusty environments, environments with polluting and/or corroding conditions, environments with large temperature fluctuations, installations with a risk of overvoltages due to switching of equipment and/or atmospheric discharges, portable equipment ...), it's recommended to test in monthly intervals.
- Pressing the test key "T" serves the only purpose of function testing the residual current device (RCD). This test does not make earthing resistance measurement (R_E), or proper checking of the earth conductor condition redundant, which must be performed separately.
- **Type -A:** Protects against special forms of residual pulsating DC which have not been smoothed.
- **Type -G:** High reliability against unwanted tripping. Suitable for any circuit where personal injury or damage to property may occur in case of unwanted tripping.
- **Type -F:** Increased protection in applications with 1phase frequency converter due to the detection of mixed frequencies, higher load capacity with smooth DC fault currents up to 10 mA.

Accessories:

Auxiliary switch for subsequent installation	ZP-IHK	286052
	ZP-WHK	286053
Tripping signal switch for subsequent installation	ZP-NHK	248437
Shunt trip release	ZP-ASA/..	248438, 248439
Tripping module	Z-KAM	248294
Terminal cover 2-poles	Z-TC/SD-2P	178099

Technical Data

		FRBm., 1+N-poles
Electrical		
Design according to		IEC/EN 61009, IEC/EN 60479-2
Classified according to		IEC 61373, EN 45545-2
Current test marks as printed onto the device		
Tripping line voltage-independent		instantaneous 250A (8/20µs), surge current-proof
Type G, F		10 ms delay 3kA (8/20µs), surge current-proof
Rated voltage	U_n	240 V AC, 50 Hz AC, A types: 50/60 Hz
Rated tripping current	$I_{\Delta n}$	10, 30, 100, 300 mA
Rated non-tripping current	$I_{\Delta no}$	0.5 $I_{\Delta n}$
Sensitivity		AC and pulsating DC
Selectivity class		3
Rated short circuit capacity		
FRBmM acc. to IEC/EN 61009	I_{cn}	10 kA
acc. to IEC/EN 60947-2: 2A - 20A:	I_{cu}	15 kA
	I_{cs}	7.5 kA
acc. to IEC/EN 60947-2: 25A-40A:	I_{cn}	10 kA
	I_{cs}	5 kA
	I_{cn}	6 kA
FRBm6 acc. to IEC/EN 61009	I_{cn}	6 kA
acc. to IEC/EN 60947-2: 2A-20A:	I_{cu}	6 kA
	I_{cs}	6 kA
acc. to IEC/EN 60947-2: 25A-40A:	I_{cu}	6 kA
	I_{cs}	5 kA
	I_{cs}	5 kA
Rated current		2 - 40 A
Rated impulse withstand voltage	U_{imp}	4 kV (1.2/50µs)
Characteristic		B, C, D
Maximum back-up fuse (short circuit protection)		100 A gL (>10 kA)
Endurance		
electrical components		≥ 4,000 operating cycles
mechanical components		≥ 10,000 operating cycles
Mechanical		
Frame size		45 mm
Device height		80 mm
Device width		35 mm (2MU)
Mounting		3-position DIN rail clip, permits removal from existing busbar system
Degree of protection switch		IP20
Degree of protection, built-in		IP40
Upper and lower terminals		open mouthed/lift terminals
Terminal protection		finger and hand touch safe, DGUV VS3, EN 50274
Terminal capacity		1 - 25 mm ²
Terminal torque		2 - 2.4 Nm
Busbar thickness		0.8 - 2 mm
Operation temperature		-25°C to +40°C
Storage- and transport temperature		-35°C to +70°C
Resistance to climatic conditions		acc. to IEC 60068-2-30 (25..55°C / 90..95% RH)

Connection diagram

1+N-poles

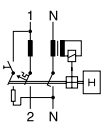

Dimensions (mm)

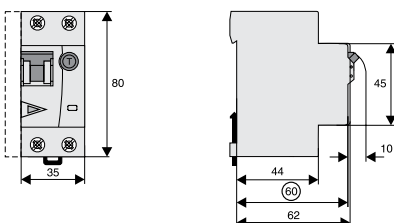

Connection of ring cable lugs (only FRB...RT)

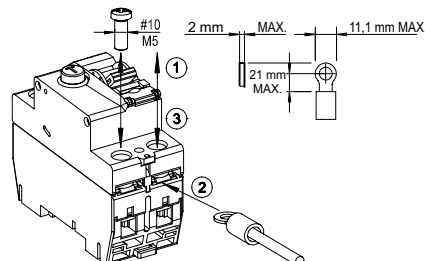

Tripping Characteristic FRBm.-./1N/, Characteristics B, C and D

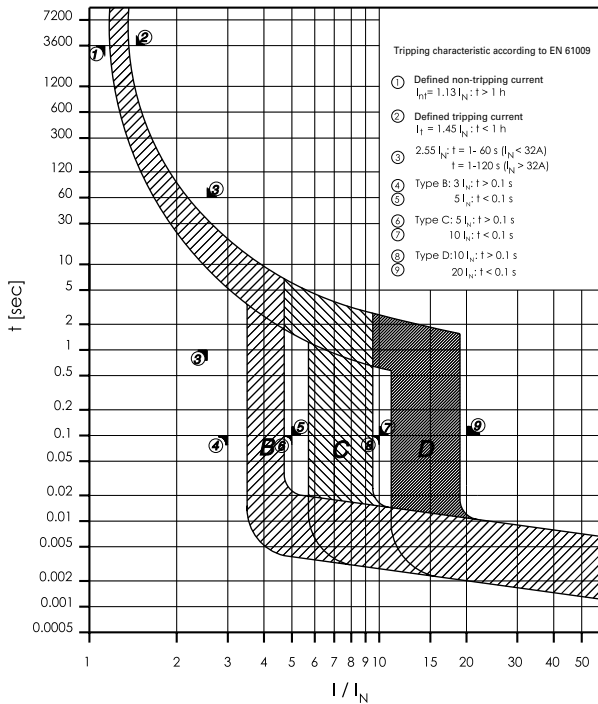

Effect of ambient temperature FRBm.-./1N/

Effect of ambient temperature (MCB component)

I_n [A]	Ambient Temperature T [°C]										
	-25	-15	-5	10	30	40	45	55	60	65	70
2	2.3	2.3	2.2	2.1	2	1.9	1.9	1.8	1.7	1.7	1.6
4	4.8	4.7	4.5	4.3	4	3.8	3.7	3.6	3.5	3.4	3.3
6	7.0	6.8	6.6	6.4	6	5.7	5.6	5.3	5.2	5.1	4.9
10	12.3	11.9	11.4	10.8	10	9.5	9.3	8.8	8.6	8.4	8.1
13	15.1	14.7	14.3	13.7	13	12.5	12.3	11.8	11.6	11.3	11.1
16	19.1	18.6	18.0	17.1	16	15.2	14.9	14.1	13.8	13.4	13.0
20	24.8	23.9	23.0	21.7	20	19.0	18.5	17.5	17.0	16.5	16.1
25	31.4	30.2	29.1	27.3	25	23.9	23.3	22.1	21.6	21.1	20.4
32	40.1	38.6	37.1	34.9	32	30.4	29.6	28.0	27.3	26.5	25.7
40	51.0	49.0	47.0	44.0	40	38.1	37.1	35.1	34.1	33.1	32.1

Let-through Energy FRBmM-.../1N/

Let-through Energy FRBmM, Characteristic B, 1+Npolig

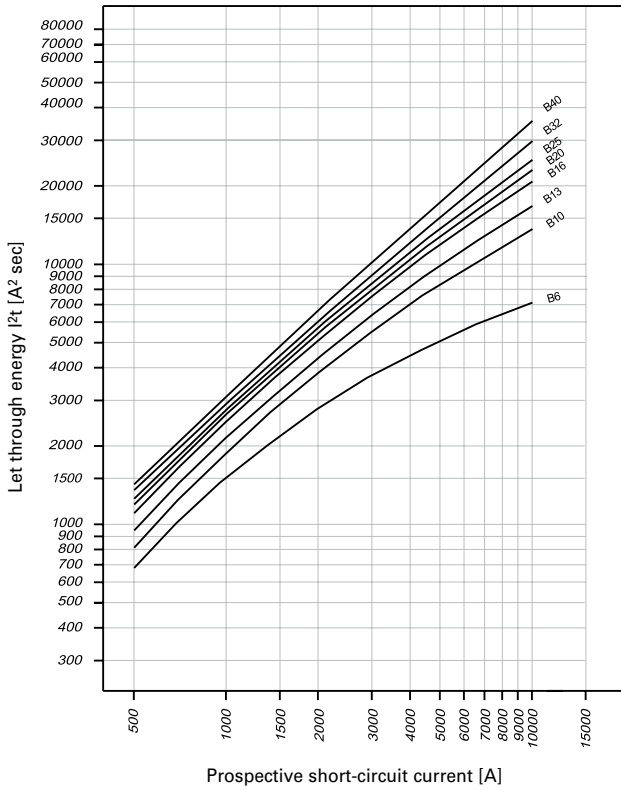

Let-through Energy FRBmM, Characteristic C, 1+Npolig

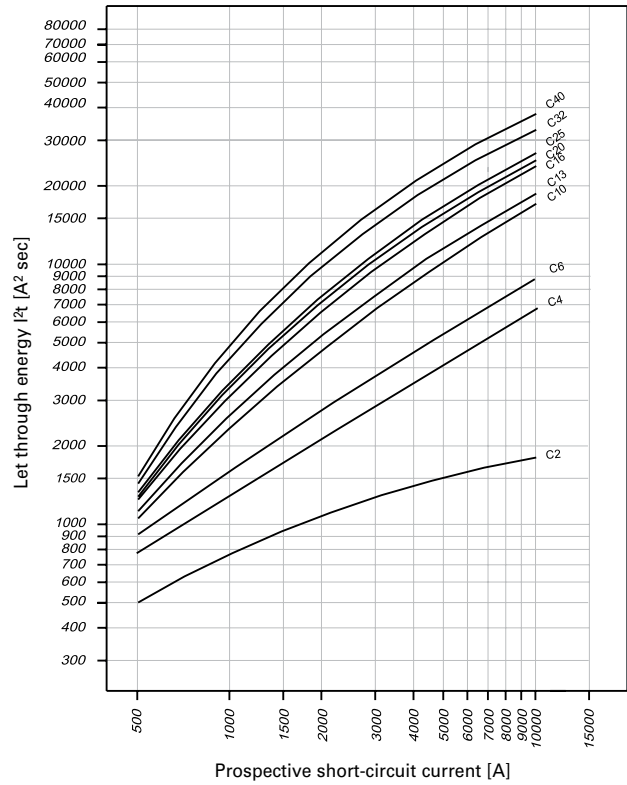

Let-through Energy FRBmM, Characteristic D, 1+Npolig

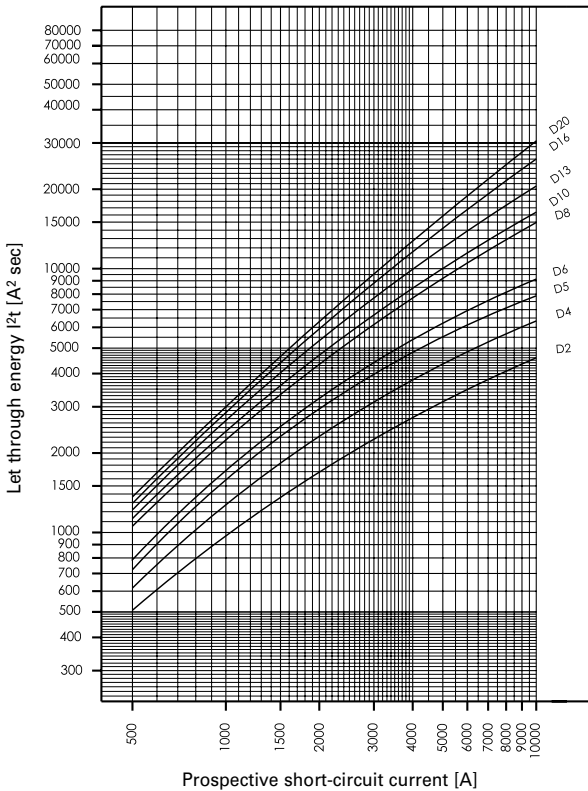

Short-circuit Selectivity FRBmM-../1N/

In case of a short-circuit, selectivity is provided up to the specified selective current values I_s (kA) applicable between the FRBmM RCD/MCB circuit breakers and the up-stream protective devices.

When a short-circuit occurs, this means that with I_{KS} current values below I_s only the MCB will trip. However, in case of short-circuit currents beyond these values both protective devices will trip.

FRBmM-../1N/ and DII-DIV fuse link

Short-circuit Selectivity **Characteristic B** towards fuse link **DII-DIV***)

FRBmM I_n [A]	DII-DIV gL/gG								
	10	16	20	25	35	50	63	80	100
6	<0.5 ¹⁾	0.7	1.0	2.9	6.9	10.0 ²⁾	10.0 ²⁾	10.0 ²⁾	
10		0.6	0.9	1.9	3.3	7.0	10.0 ²⁾	10.0 ²⁾	
13		0.5	0.7	1.6	2.8	5.7	9.0	10.0 ²⁾	
16			0.7	1.4	2.4	4.4	7.0	10.0 ²⁾	
20				1.3	2.2	4.0	6.3	10.0 ²⁾	
25				1.3	2.1	3.8	5.8	10.0 ²⁾	
32					2.0	3.5	5.2	9.5	
40						3.1	4.5	8.1	

¹⁾ Selectivity-limit current I_s under 0.5 kA.

²⁾ Selectivity-limit current I_s = Rated breaking capacity I_{cn} of the RCD/MCB device

Darker areas: no selectivity

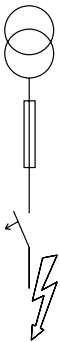

Short-circuit Selectivity **Characteristic C** towards fuse link **DII-DIV***)

FRBmM I_n [A]	DII-DIV gL/gG									
	10	16	20	25	35	50	63	80	100	
2	<0.5 ¹⁾	<0.5 ¹⁾	1.7	6.0	10.0 ²⁾	10.0 ²⁾	10.0 ²⁾	10.0 ²⁾	10.0 ²⁾	
4	<0.5 ¹⁾	<0.5 ¹⁾	0.7	1.3	4.2	8.5	10.0 ²⁾	10.0 ²⁾	10.0 ²⁾	
6		<0.5 ¹⁾	0.6	1.0	2.9	5.8	10.0 ²⁾	10.0 ²⁾	10.0 ²⁾	
10			<0.5	0.7	1.5	2.6	5.3	9.0	10.0 ²⁾	
13					1.4	2.3	4.6	7.6	10.0 ²⁾	
16					1.2	1.8	3.4	5.5	10.0 ²⁾	
20					1.2	1.7	3.1	5.0	10.0 ²⁾	
25						1.6	2.9	4.6	10.0 ²⁾	
32							2.3	3.4	7.7	
40								2.9	6.2	

Short-circuit Selectivity **Characteristic D** towards fuse link **DII-DIV***)

FRBmM I_n [A]	DII-DIV gL/gG								
	10	16	20	25	35	50	63	80	100
2	<0.5 ¹⁾	<0.5 ¹⁾	1.0	1.8	6.5	10.0 ²⁾	10.0 ²⁾	10.0 ²⁾	10.0 ²⁾
4		<0.5 ¹⁾	0.8	1.3	3.8	9.0	10.0 ²⁾	10.0 ²⁾	10.0 ²⁾
6			0.6	0.9	2.3	4.7	10.0 ²⁾	10.0 ²⁾	10.0 ²⁾
10				0.7	1.5	2.6	5.5	9.4	10.0 ²⁾
13					1.4	2.2	4.4	7.0	10.0 ²⁾
16						2.0	3.7	5.5	10.0 ²⁾
20						1.9	3.4	5.0	10.0 ²⁾

FRBmM-../1N/ and D01-D03 fuse link

Short-circuit Selectivity **Characteristic B** towards fuse link **D01-D03***)

FRBmM	D01-D03 gL/gG								
	10	16	20	25	35	50	63	80	100
I_n [A]									
6		<0.5 ¹⁾	0.5	0.8	2.4	8.2	10.0 ²⁾	10.0 ²⁾	10.0 ²⁾
10			0.5	0.8	1.6	3.7	6.0	10.0 ²⁾	10.0 ²⁾
13			0.6	0.7	1.4	3.0	4.7	9.0	10.0 ²⁾
16				0.6	1.2	2.6	3.9	7.0	10.0 ²⁾
20					1.2	2.5	3.6	6.2	10.0 ²⁾
25					1.2	2.3	3.3	5.7	10.0 ²⁾
32						2.3	3.1	5.1	10.0 ²⁾
40							2.8	4.5	9.5

¹⁾ Selectivity-limit current I_s under 0.5 kA.

²⁾ Selectivity-limit current I_s = Rated breaking capacity I_{cn} of the RCD/MCB device

Darker areas: no selectivity

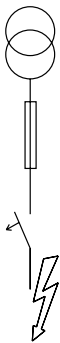

Short-circuit Selectivity **Characteristic C** towards fuse link **D01-D03***)

FRBmM	D01-D03 gL/gG								
	10	16	20	25	35	50	63	80	100
I_n [A]									
2		<0.5 ¹⁾	0.5	0.5	2.4	10.0 ²⁾	10.0 ²⁾	10.0 ²⁾	10.0 ²⁾
4		<0.5 ¹⁾	<0.5 ¹⁾	<0.5 ¹⁾	0.9	3.4	9.5	10.0 ²⁾	10.0 ²⁾
6			<0.5 ¹⁾	<0.5 ¹⁾	0.8	2.3	6.5	10.0 ²⁾	10.0 ²⁾
10				<0.5	0.6	1.3	2.9	4.5	8.9
13						1.2	2.5	3.9	7.6
16						1.0	2.1	3.0	5.5
20						1.0	2.0	2.7	5.0
25							1.9	2.6	4.5
32								2.1	3.4
40									3.0

Short-circuit Selectivity **Characteristic D** towards fuse link **D01-D03***)

FRBmM	D01-D03 gL/gG								
	10	16	20	25	35	50	63	80	100
I_n [A]									
2		<0.5 ¹⁾	0.5	0.8	1.2	5.0	10.0 ²⁾	10.0 ²⁾	10.0 ²⁾
4			<0.5 ¹⁾	0.7	1.0	3.0	10.0 ²⁾	10.0 ²⁾	10.0 ²⁾
6				0.5	0.8	1.9	5.5	10.0 ²⁾	10.0 ²⁾
10					0.6	1.3	2.9	4.7	9.2
13						1.2	2.5	3.8	7.0
16							2.3	3.2	5.5
20							2.2	3.0	3.9

FRBmM-../1N/ and NH-00 fuse link

Short-circuit Selectivity **Characteristic B** towards fuse link **NH-00***)

FRBmM	NH-00 gL/gG											
	16	20	25	32	35	40	50	63	80	100	125	160
I_n [A]												
6		<0.5 ¹⁾	0.5	0.8	1.4	2.2	3.3	7.0	10.0 ²⁾	10.0 ²⁾	10.0 ²⁾	10.0 ²⁾
10		<0.5 ¹⁾	0.7	0.9	1.5	2.1	3.4	4.3	7.3	10.0 ²⁾	10.0 ²⁾	10.0 ²⁾
13		<0.5 ¹⁾	0.6	0.8	1.4	1.8	2.8	3.6	5.7	10.0 ²⁾	10.0 ²⁾	10.0 ²⁾
16			0.6	0.7	1.2	1.5	2.4	3.0	4.5	10.0 ²⁾	10.0 ²⁾	10.0 ²⁾
20				0.7	1.1	1.5	2.2	2.8	4.2	9.2	10.0 ²⁾	10.0 ²⁾
25				0.7	1.1	1.4	2.1	2.6	4.0	8.2	10.0 ²⁾	10.0 ²⁾
32					1.0	1.4	2.0	2.5	3.7	7.1	10.0 ²⁾	10.0 ²⁾
40							2.3	3.4	6.2	8.8	10.0 ²⁾	

¹⁾ Selectivity-limit current I_s under 0.5 kA.

²⁾ Selectivity-limit current I_s = Rated breaking capacity I_{cn} of the RCD/MCB device

Darker areas: no selectivity



Short-circuit Selectivity **Characteristic C** towards fuse link **NH-00***)

FRBmM	NH-00 gL/gG											
	16	20	25	32	35	40	50	63	80	100	125	160
I_n [A]												
2		<0.5 ¹⁾	0.6	2.6	10.0 ²⁾	10.0 ²⁾	10.0 ²⁾	10.0 ²⁾	10.0 ²⁾	10.0 ²⁾	10.0 ²⁾	10.0 ²⁾
4		<0.5 ¹⁾	<0.5 ¹⁾	0.9	1.8	3.2	4.8	8.7	10.0 ²⁾	10.0 ²⁾	10.0 ²⁾	10.0 ²⁾
6		<0.5 ¹⁾	<0.5 ¹⁾	0.7	1.3	2.2	3.3	5.9	8.0	10.0 ²⁾	10.0 ²⁾	10.0 ²⁾
10				0.5	0.8	1.2	1.7	2.7	3.4	5.5	10.0 ²⁾	10.0 ²⁾
13						1.1	1.5	2.3	2.9	4.7	10.0 ²⁾	10.0 ²⁾
16						1.0	1.3	1.8	2.3	3.7	8.7	10.0 ²⁾
20						0.9	1.1	1.7	2.2	3.4	8.0	10.0 ²⁾
25							1.6	2.1	3.2	7.2	10.0 ²⁾	10.0 ²⁾
32								1.7	2.6	5.3	9.0	10.0 ²⁾
40									2.4	4.5	7.5	10.0

Short-circuit Selectivity **Characteristic D** towards fuse link **NH-00***)

FRBmM	NH-00 gL/gG											
	16	20	25	32	35	40	50	63	80	100	125	160
I_n [A]												
2		<0.5 ¹⁾	0.6	1.3	2.5	4.7	7.7	10.0 ²⁾	10.0 ²⁾	10.0 ²⁾	10.0 ²⁾	10.0 ²⁾
4		<0.5 ¹⁾	0.5	0.9	1.6	2.8	4.3	9.2	10.0 ²⁾	10.0 ²⁾	10.0 ²⁾	10.0 ²⁾
6			<0.5 ¹⁾	0.7	1.2	1.8	2.6	4.9	7.0	10.0 ²⁾	10.0 ²⁾	10.0 ²⁾
10				0.5	0.8	1.2	1.7	2.7	3.5	5.6	10.0 ²⁾	10.0 ²⁾
13						1.1	1.5	2.3	2.9	4.5	10.0 ²⁾	10.0 ²⁾
16							1.4	2.0	2.6	3.9	8.0	10.0 ²⁾
20								1.9	2.4	3.6	7.0	10.0 ²⁾

SG02913



Description

- High-quality residual current device / miniature circuit breaker combination, line voltage-independent
- Increased protection in applications with 1-phase frequency converter due to the detection of mixed frequencies (type F)
- Reduction of nuisance tripping (type F or G/A) thanks to
 - time delayed tripping
 - increased current withstand capability (3 kA)
- Higher load rating with DC residual currents up to 10 mA (type F)
- Contact position indicator red - green
- Fault current tripping indicator white - blue
- Guide for secure terminal connection
- 3-position DIN rail clip, permits removal from existing busbar system
- Comprehensive range of accessories suitable for subsequent installation
- Wide variety of rated tripping currents
- Rated currents up to 40 A
- Tripping characteristics B, C
- Rated breaking capacity 10 kA and 6 kA
- Classified for the use in rail rolling stock

$I_n/I_{\Delta n}$
(A)

Type
Designation

Article No. Units per
package

Type F

10 kA, 2-poles

Sensitive to residual pulsating DC, surge current proof 3000 A, Type F  

SG02913



Characteristic B

10/0.03	FRBmM-B10/2/003-F	196976	1/60
13/0.03	FRBmM-B13/2/003-F	196977	1/60
16/0.03	FRBmM-B16/2/003-F	196978	1/60
20/0.03	FRBmM-B20/2/003-F	196979	1/60
25/0.03	FRBmM-B25/2/003-F	196980	1/60

SG02913



Characteristic C

6/0.03	FRBmM-C6/2/003-F	196968	1/60
10/0.03	FRBmM-C10/2/003-F	196969	1/60
13/0.03	FRBmM-C13/2/003-F	196970	1/60
16/0.03	FRBmM-C16/2/003-F	196971	1/60
20/0.03	FRBmM-C20/2/003-F	196972	1/60
25/0.03	FRBmM-C25/2/003-F	196967	1/60

Type G/A

10 kA, 2-poles

Sensitive to residual pulsating DC, surge current proof 3000 A, Type G/A 

SG02913



Characteristic B

10/0.03	FRBmM-B10/2/003-G/A	196960	1/60
13/0.03	FRBmM-B13/2/003-G/A	196961	1/60
16/0.03	FRBmM-B16/2/003-G/A	196962	1/60
20/0.03	FRBmM-B20/2/003-G/A	196963	1/60
25/0.03	FRBmM-B25/2/003-G/A	196964	1/60

SG02913



Characteristic C

6/0.03	FRBmM-C6/2/003-G/A	196951	1/60
10/0.03	FRBmM-C10/2/003-G/A	196952	1/60
13/0.03	FRBmM-C13/2/003-G/A	196953	1/60
15/0.03	FRBmM-C16/2/003-G/A	196954	1/60
16/0.03	FRBmM-C20/2/003-G/A	196955	1/60
20/0.03	FRBmM-C25/2/003-G/A	196956	1/60

$I_n/I_{\Delta n}$
(A)

Type
Designation

Article No.

Units per
package

Type Super A

10 kA, 2-poles

Conditionally surge current-proof 250 A, sensitive to residual pulsating DC, short-time delayed, Type Super A 

SG02913



Characteristic B

10/0.03	FRBmM-B10/2/003-LiA	170886	1/60
13/0.03	FRBmM-B13/2/003-LiA	170887	1/60
16/0.03	FRBmM-B16/2/003-LiA	170888	1/60
20/0.03	FRBmM-B20/2/003-LiA	170889	1/60
25/0.03	FRBmM-B25/2/003-LiA	170890	1/60
10/0.1	FRBmM-B10/2/01-LiA	170810	1/60
13/0.1	FRBmM-B13/2/01-LiA	170811	1/60
16/0.1	FRBmM-B16/2/01-LiA	170812	1/60
20/0.1	FRBmM-B20/2/01-LiA	170813	1/60
25/0.1	FRBmM-B25/2/01-LiA	170814	1/60

SG02913



Characteristic C

6/0.03	FRBmM-C6/2/003-LiA	170795	1/60
10/0.03	FRBmM-C10/2/003-LiA	170796	1/60
13/0.03	FRBmM-C13/2/003-LiA	170797	1/60
16/0.03	FRBmM-C16/2/003-LiA	170798	1/60
20/0.03	FRBmM-C20/2/003-LiA	170799	1/60
25/0.03	FRBmM-C25/2/003-LiA	170800	1/60
6/0.1	FRBmM-C6/2/01-LiA	170829	1/60
10/0.1	FRBmM-C10/2/01-LiA	170830	1/60
13/0.1	FRBmM-C13/2/01-LiA	170831	1/60
16/0.1	FRBmM-C16/2/01-LiA	170832	1/60
20/0.1	FRBmM-C20/2/01-LiA	170833	1/60
25/0.1	FRBmM-C25/2/01-LiA	170834	1/60

$I_n/I_{\Delta n}$
(A)

Type
Designation

Article No.

Units per
package

Type A

10 kA, 2-poles

Conditionally surge current-proof 250 A, sensitive to residual pulsating DC, Type A 

SG02913



Characteristic B

10/0.03	FRBmM-B10/2/003-A	170879	1/60
13/0.03	FRBmM-B13/2/003-A	170880	1/60
16/0.03	FRBmM-B16/2/003-A	170881	1/60
20/0.03	FRBmM-B20/2/003-A	170882	1/60
25/0.03	FRBmM-B25/2/003-A	170883	1/60
10/0.1	FRBmM-B10/2/01-A	170803	1/60
13/0.1	FRBmM-B13/2/01-A	170804	1/60
16/0.1	FRBmM-B16/2/01-A	170805	1/60
20/0.1	FRBmM-B20/2/01-A	170806	1/60
25/0.1	FRBmM-B25/2/01-A	170807	1/60
10/0.3	FRBmM-B10/2/03-A	170844	1/60
13/0.3	FRBmM-B13/2/03-A	170845	1/60
16/0.3	FRBmM-B16/2/03-A	170846	1/60
20/0.3	FRBmM-B20/2/03-A	170847	1/60
25/0.3	FRBmM-B25/2/03-A	170848	1/60

SG02913



Characteristic C

6/0.03	FRBmM-C6/2/003-A	170785	1/60
10/0.03	FRBmM-C10/2/003-A	170786	1/60
13/0.03	FRBmM-C13/2/003-A	170787	1/60
16/0.03	FRBmM-C16/2/003-A	170788	1/60
20/0.03	FRBmM-C20/2/003-A	170789	1/60
25/0.03	FRBmM-C25/2/003-A	170790	1/60
6/0.1	FRBmM-C6/2/01-A	170819	1/60
10/0.1	FRBmM-C10/2/01-A	170820	1/60
13/0.1	FRBmM-C13/2/01-A	170821	1/60
16/0.1	FRBmM-C16/2/01-A	170822	1/60
20/0.1	FRBmM-C20/2/01-A	170823	1/60
25/0.1	FRBmM-C25/2/01-A	170824	1/60
6/0.3	FRBmM-C6/2/03-A	170863	1/60
10/0.3	FRBmM-C10/2/03-A	170864	1/60
13/0.3	FRBmM-C13/2/03-A	170865	1/60
16/0.3	FRBmM-C16/2/03-A	170866	1/60
20/0.3	FRBmM-C20/2/03-A	170867	1/60
25/0.3	FRBmM-C25/2/03-A	170730	1/60

1.112 Combined RCD/MCB Devices

Combined RCD/MCB Devices FRBmM 2-poles

$I_n/I_{\Delta n}$ (A)	Type Designation	Article No.	Units per package
---------------------------	---------------------	-------------	----------------------

Type AC

10 kA, 2-poles

Conditionally surge current-proof 250 A, Type AC 

SG02913



Characteristic B

10/0.03	FRBmM-B10/2/003	170872	1/60
13/0.03	FRBmM-B13/2/003	170873	1/60
16/0.03	FRBmM-B16/2/003	170874	1/60
20/0.03	FRBmM-B20/2/003	170875	1/60
25/0.03	FRBmM-B25/2/003	170876	1/60
10/0.3	FRBmM-B10/2/03	170837	1/60
13/0.3	FRBmM-B13/2/03	170838	1/60
16/0.3	FRBmM-B16/2/03	170839	1/60
20/0.3	FRBmM-B20/2/03	170840	1/60
25/0.3	FRBmM-B25/2/03	170841	1/60

SG02913



Characteristic C

6/0.03	FRBmM-C6/2/003	170721	1/60
10/0.03	FRBmM-C10/2/003	170722	1/60
13/0.03	FRBmM-C13/2/003	170723	1/60
16/0.03	FRBmM-C16/2/003	170724	1/60
20/0.03	FRBmM-C20/2/003	170725	1/60
25/0.03	FRBmM-C25/2/003	170726	1/60
6/0.3	FRBmM-C6/2/03	170853	1/60
10/0.3	FRBmM-C10/2/03	170854	1/60
13/0.3	FRBmM-C13/2/03	170855	1/60
16/0.3	FRBmM-C16/2/03	170856	1/60
20/0.3	FRBmM-C20/2/03	170857	1/60
25/0.3	FRBmM-C25/2/03	170858	1/60

$I_n/I_{\Delta n}$
(A)

Type
Designation

Article No. Units per
package

Type A

10 kA, 2-poles

120 V, Conditionally surge current-proof 250 A, sensitive to residual pulsating DC, Type A 

SG02913



Characteristic B

$I_n/I_{\Delta n}$ (A)	Type Designation	Article No.	Units per package
10/0.03	FRBmM-B10/2/003-A-120	302367	1/60
13/0.03	FRBmM-B13/2/003-A-120	302368	1/60
15/0.03	FRBmM-B15/2/003-A-120-OL	302359	1/60
16/0.03	FRBmM-B16/2/003-A-120	302369	1/60
20/0.03	FRBmM-B20/2/003-A-120	302370	1/60
25/0.03	FRBmM-B25/2/003-A-120	302371	1/60

SG02913



Characteristic C

$I_n/I_{\Delta n}$ (A)	Type Designation	Article No.	Units per package
6/0.03	FRBmM-C6/2/003-A-120	171788	1/60
10/0.03	FRBmM-C10/2/003-A-120	171789	1/60
13/0.03	FRBmM-C13/2/003-A-120	171790	1/60
15/0.03	FRBmM-C15/2/003-A-120-OL	302362	1/60
16/0.03	FRBmM-C16/2/003-A-120	171791	1/60
20/0.03	FRBmM-C20/2/003-A-120	171792	1/60
25/0.03	FRBmM-C25/2/003-A-120	171793	1/60

$I_n/I_{\Delta n}$
(A)

Type
Designation

Article No.

Units per
package

Type F

6 kA, 2-poles

Sensitive to residual pulsating DC, surge current proof 3000 A, Type F  

SG02913



Characteristic B

32/0.03	FRBm6-B32/2/003-F	196981	1/60
40/0.03	FRBm6-B40/2/003-F	196982	1/60

SG02913



Characteristic C

32/0.03	FRBm6-C32/2/003-F	196973	1/60
40/0.03	FRBm6-C40/2/003-F	196974	1/60

Type G/A

6 kA, 2-poles

Sensitive to residual pulsating DC, surge current proof 3000 A, Type G/A 

SG02913



Characteristic B

32/0.03	FRBm6-B32/2/003-G/A	196965	1/60
40/0.03	FRBm6-B40/2/003-G/A	196966	1/60

SG02913



Characteristic C

32/0.03	FRBm6-C32/2/003-G/A	196957	1/60
40/0.03	FRBm6-C40/2/003-G/A	196958	1/60

$I_n/I_{\Delta n}$
(A)

Type
Designation

Article No. Units per
package

Type Super A

6 kA, 2-poles

Conditionally surge current-proof 250 A, sensitive to residual pulsating DC, short-time delayed, Type Super A 

SG02913



Characteristic B

32/0.03	FRBm6-B32/2/003-LiA	170891	1/60
40/0.03	FRBm6-B40/2/003-LiA	170718	1/60
32/0.1	FRBm6-B32/2/01-LiA	170815	1/60
40/0.1	FRBm6-B40/2/01-LiA	170816	1/60

SG02913



Characteristic C

32/0.03	FRBm6-C32/2/003-LiA	170801	1/60
40/0.03	FRBm6-C40/2/003-LiA	170802	1/60
32/0.1	FRBm6-C32/2/01-LiA	170835	1/60
40/0.1	FRBm6-C40/2/01-LiA	170836	1/60

Type A

6 kA, 2-poles

Conditionally surge current-proof 250 A, sensitive to residual pulsating DC, Type A 

SG02913



Characteristic B

32/0.03	FRBm6-B32/2/003-A	170884	1/60
40/0.03	FRBm6-B40/2/003-A	170885	1/60
32/0.1	FRBm6-B32/2/01-A	170808	1/60
40/0.1	FRBm6-B40/2/01-A	170809	1/60
32/0.3	FRBm6-B32/2/03-A	170849	1/60
40/0.3	FRBm6-B40/2/03-A	170850	1/60

SG02913



Characteristic C

32/0.03	FRBm6-C32/2/003-A	170791	1/60
40/0.03	FRBm6-C40/2/003-A	170792	1/60
32/0.1	FRBm6-C32/2/01-A	170825	1/60
40/0.1	FRBm6-C40/2/01-A	170826	1/60
32/0.3	FRBm6-C32/2/03-A	170731	1/60
40/0.3	FRBm6-C40/2/03-A	170732	1/60

1.116 Combined RCD/MCB Devices

Combined RCD/MCB Devices FRBm6 2-poles

$I_n/I_{\Delta n}$ (A)	Type Designation	Article No.	Units per package
---------------------------	---------------------	-------------	----------------------

Type AC

6 kA, 2-poles

Conditionally surge current-proof 250 A, Type AC 

SG02913



Characteristic B

32/0.03	FRBm6-B32/2/003	170877	1/60
40/0.03	FRBm6-B40/2/003	170878	1/60
32/0.3	FRBm6-B32/2/03	170842	1/60
40/0.3	FRBm6-B40/2/03	170843	1/60

SG02913



Characteristic C

32/0.03	FRBm6-C32/2/003	170727	1/60
40/0.03	FRBm6-C40/2/003	170728	1/60
32/0.3	FRBm6-C32/2/03	170859	1/60
40/0.3	FRBm6-C40/2/03	170860	1/60

Specifications | Combined RCD/MCB Devices FRBmM, FRBm6, 2-poles

Description

- Combined RCD/MCB device
- Line voltage-independent tripping
- Compatible with standard busbar
- Twin-purpose terminal (lift/open-mouthed) above and below
- Busbar positioning optionally above or below
- Free terminal space despite installed busbar
- Guide for secure terminal connection
- Contact position indicator red - green
- Fault current tripping indicator white - blue
- Comprehensive range of accessories suitable for subsequent installation
- The test key "T" must be pressed every 6 months. The system operator must be informed of this obligation and his responsibility in a way that can be proven. Under special conditions (e.g. damply and/or dusty environments, environments with polluting and/or corroding conditions, environments with large temperature fluctuations, installations with a risk of overvoltages due to switching of equipment and/or atmospheric discharges, portable equipment ...), it's recommended to test in monthly intervals.
- Pressing the test key "T" serves the only purpose of function testing the residual current device (RCD). This test does not make earthing resistance measurement (R_E), or proper checking of the earth conductor condition redundant, which must be performed separately.
- **Type -A:** Protects against special forms of residual pulsating DC which have not been smoothed.
- **Type -Super A:** High reliability against unwanted tripping. Suitable any circuit where personal injury or damage to property may occur in case of unwanted tripping.
- **Type -G/A:** High reliability against unwanted tripping. Suitable for any circuit where personal injury or damage to property may occur in case of unwanted tripping. Additionally protects against special forms of residual pulsating DC which have not been smoothed.
- **Type -F:** Sensitive to pulsating DC residual current and detection of multifrequency residual currents up to 1 kHz
 - Increased protection due to the detection of mixed frequencies
 - Higher load rating with DC residual currents up to 10mA
 - Reduction of nuisance tripping thanks to time delayed tripping and increased current withstand capability of 3 kA
 Recommended for washing machines, dish washers, or motor applications with single-phase drives.

Accessories:

Auxiliary switch for subsequent installation	ZP-IHK	286052
	ZP-WHK	286053
Tripping signal switch for subsequent installation	ZP-NHK	248437
Shunt trip release	ZP-ASA/..	248438, 248439
Terminal cover 2-poles	Z-TC/SD-2P	178099

Technical Data

		FRBmM, FRBm6 2-poles	
Electrical			
Design according to		IEC/EN 61009 Type G according to ÖVE E 8601 IEC 61373, EN 45545-2	
Classified according to			
Current test marks as printed onto the device			
Tripping line voltage-independent		instantaneous tripping, conditional surge current proof 250 A (8/20 µs) surge current proof 3 kA (8/20 µs) (F, -G/A)	
Rated voltage			
FRBmM, FRBm6	U_n	240 V AC, 50 Hz	
FRBmM 120 V	U_n	120 V AC, 50/60 Hz	
Rated tripping current			
FRBmM, FRBm6	$I_{\Delta n}$	30, 100, 300 mA	
FRBmM 120 V	$I_{\Delta n}$	30 mA	
Rated non-tripping current	$I_{\Delta no}$	0.5 $I_{\Delta n}$	
Sensitivity		AC and pulsating DC, Type F according to IEC/EN 62423	
Selectivity class		3	
Rated short circuit capacity			
FRBmM	I_{cn}	10 kA	
FRBm6	I_{cn}	6 kA	
Rated current			
FRBmM, FRBm6		6 - 40 A	
FRBmM 120 V		6 - 25 A	
Rated impulse withstand voltage	U_{imp}	4 kV (1.2/50µs)	
Characteristic		B, C	
Maximum back-up fuse (short circuit protection)		100 A gL (>10 kA)	
Endurance			
electrical components		≥ 4,000 operating cycles	
mechanical components		≥ 10,000 operating cycles	
Mechanical			
Frame size		45 mm	
Device height		80 mm	
Device width		35 mm (2MU)	
Mounting		3-position DIN rail clip, permits removal from existing busbar system	
Degree of protection switch		IP20	
Degree of protection, built-in		IP40	
Upper and lower terminals		open mouthed/lift terminals	
Terminal protection		finger and hand touch safe, DGUV VS3, EN 50274	
Terminal capacity		1 - 25 mm ²	
Terminal torque		2 - 2.4 Nm	
Busbar thickness		0.8 - 2 mm	
Operation temperature		-25°C to +40°C	
Storage- and transport temperature		-35°C to +60°C	
Resistance to climatic conditions		acc. to IEC 60068-2-30 (25..55°C / 90..95% RH)	

Connection diagram

2-poles

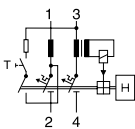

Dimensions (mm)

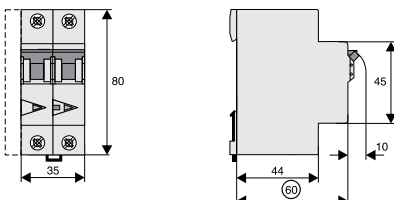

Tripping Characteristic FRBm. 2-poles, Characteristics B and C

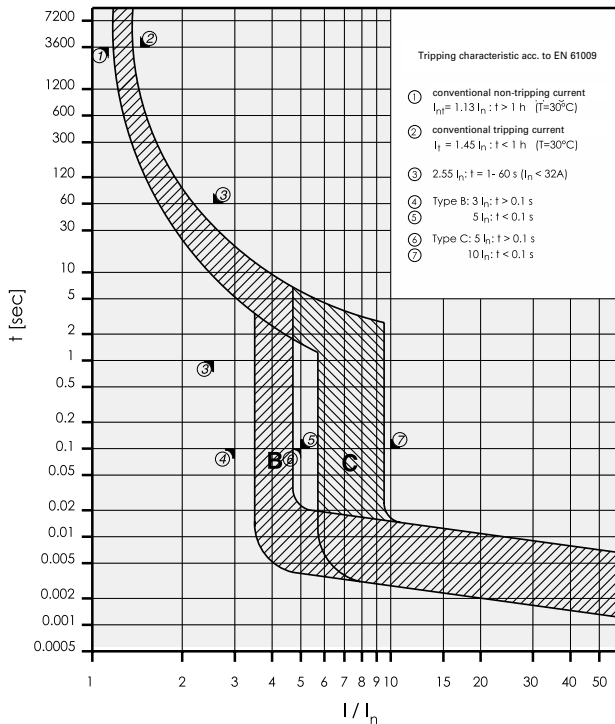

Internal Resistance FRBmM 2-poles

	Type B	Type C
At room temperature (single pole)		
I_n [A]	R* [mΩ]	R* [mΩ]
6	29,7	29,7
10	19,1	19,1
13	17,4	17,4
16	12,2	12,2
20	9,3	9,3
25	4,9	4,9
32	5,6	5,6
40	4,6	4,6

* 50Hz

Internal Resistance FRBm6 2-poles

	Type B/C
At room temperature (single pole)	
I_n [A]	R* [mΩ]
10	36.1
13	25.9
16	18.6
20	14.2
25	8.0
32	7.3
40	5.6

* 50Hz

Power Loss at I_n FRBmM 2-poles

	Type B	Type C
(entire unit)		
I_n [A]	P* [W]	P* [W]
6	2,2	2,2
10	4,3	4,3
13	4,0	4,0
16	5,0	5,0
20	5,9	5,9
25	4,6	4,6
32	5,5	5,5
40	6,7	6,7

* 50Hz and ambient temperature

Power Loss at I_n FRBm6 2-poles

	Type B/C
(entire unit)	
I_n [A]	P* [W]
10	4.1
13	5.2
16	5.7
20	7.0
25	5.6
32	8.7
40	10.9

* 50Hz and ambient temperature

FRBmM: Influence of ambient temperature on load carrying capacity

- Values = max. allowed current in Ampere at the specific temperature
- Temperature factor (%/K) = 0.5

I_n [A]	Ambient temperature / °C									
	-40	-30	-25	-20	-10	0	10	20	30	40
6	8.1	7.8	7.7	7.5	7.2	6.9	6.6	6.3	6.0	5.7
10	13.5	13.0	12.8	12.5	12.0	11.5	11.0	10.5	10.0	9.5
13	17.6	16.9	16.6	16.3	15.6	15.0	14.3	13.7	13.0	12.4
16	21.6	20.8	20.4	20.0	19.2	18.4	17.6	16.8	16.0	15.2
20	27.0	26.0	25.5	25.0	24.0	23.0	22.0	21.0	20.0	19.0

FRBm6: Influence of ambient temperature on load carrying capacity

- Values = max. allowed current in Ampere at the specific temperature
- Temperature factor (%/K) = 0.5

I_n [A]	Ambient temperature / °C									
	-40	-30	-25	-20	-10	0	10	20	30	40
25	33.8	32.5	31.9	31.3	30.0	28.8	27.5	26.3	25.0	23.8
32	43.2	41.6	40.8	40.0	38.4	36.8	35.2	33.6	32.0	30.4
40	54.0	52.0	51.0	50.0	48.0	46.0	44.0	42.0	40.0	38.0

Let-through Energy FRBmM 2-poles

Let-through Energy FRBmM, Characteristic B, 2polig

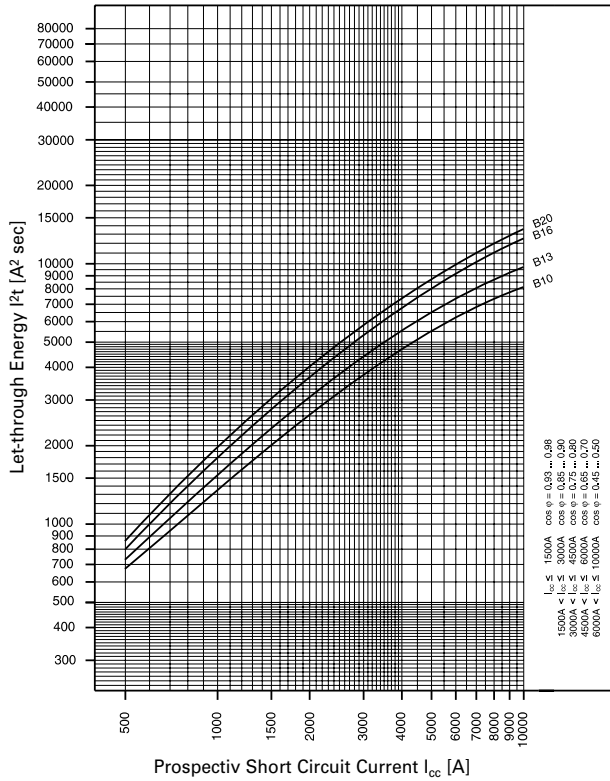

Let-through Energy FRBmM, Characteristic C, 2polig

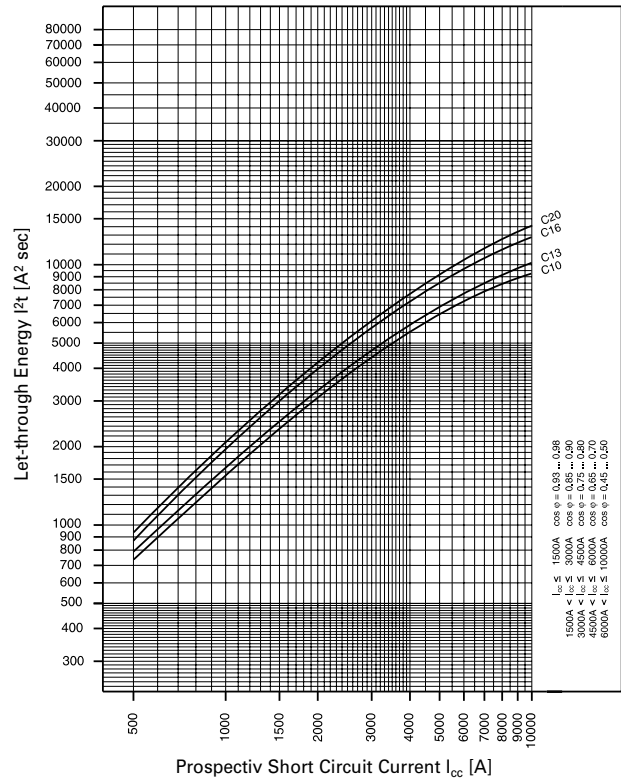

Let-through Energy FRBm6 2-poles

Let-through Energy FRBm6, Characteristic B, 2polig

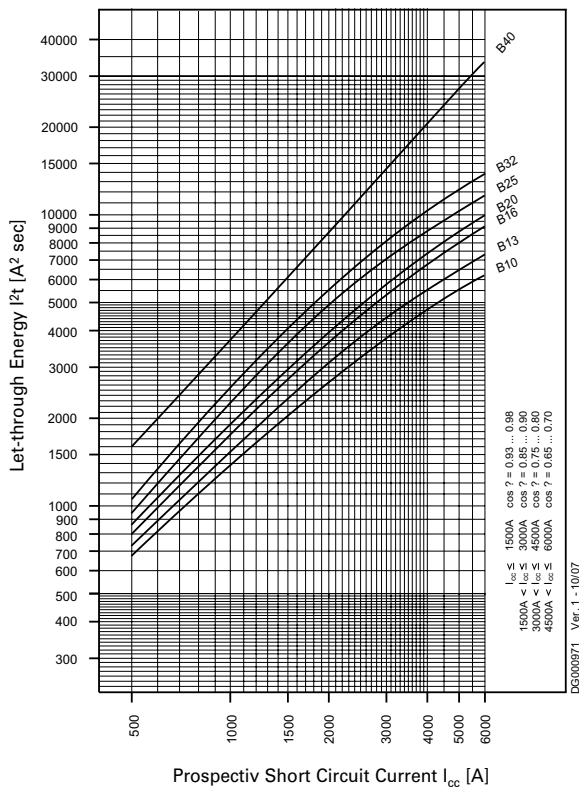

Let-through Energy FRBm6, Characteristic C, 2polig

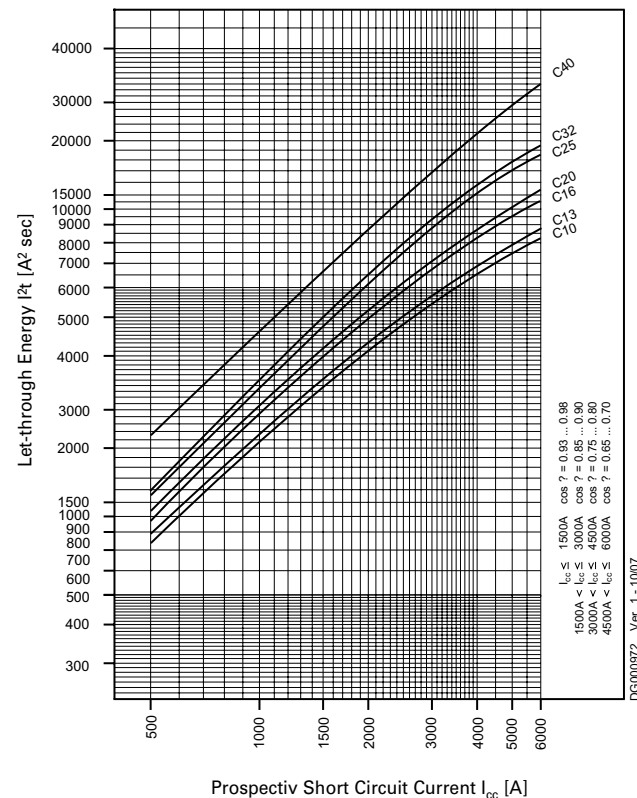

Let-through Current FRBmM 2-poles

Characteristic B

230 V

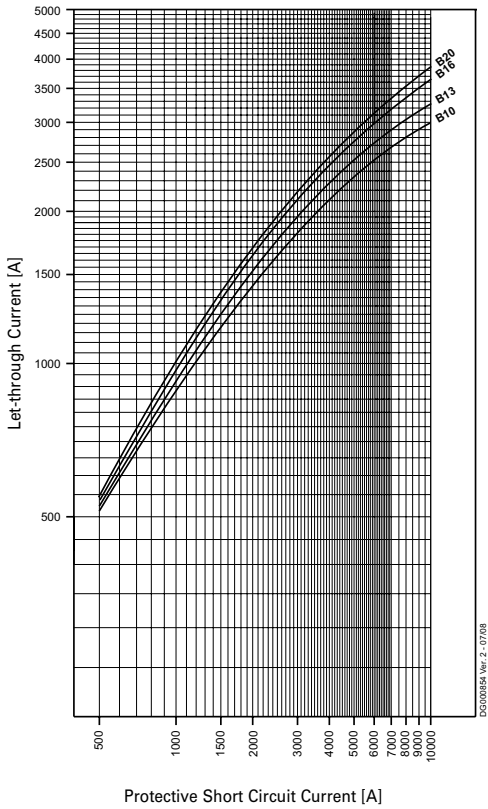

Characteristic C

230 V

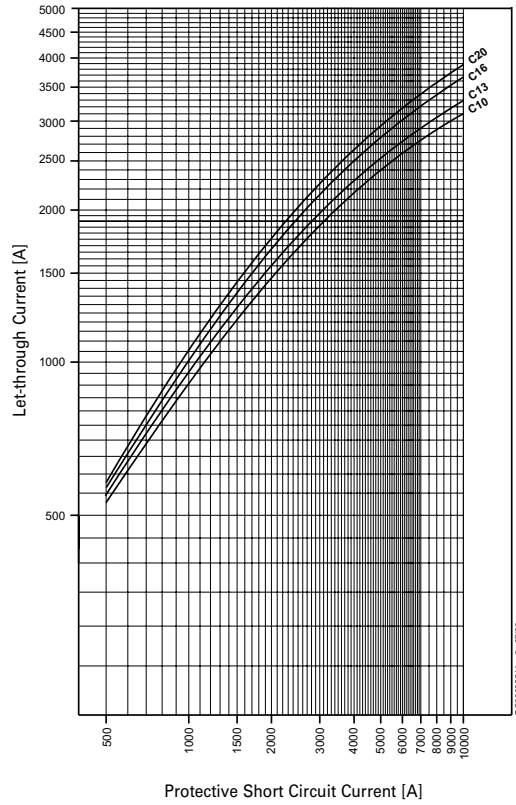

Let-through Current FRBm6 2-poles

Characteristic B

230V

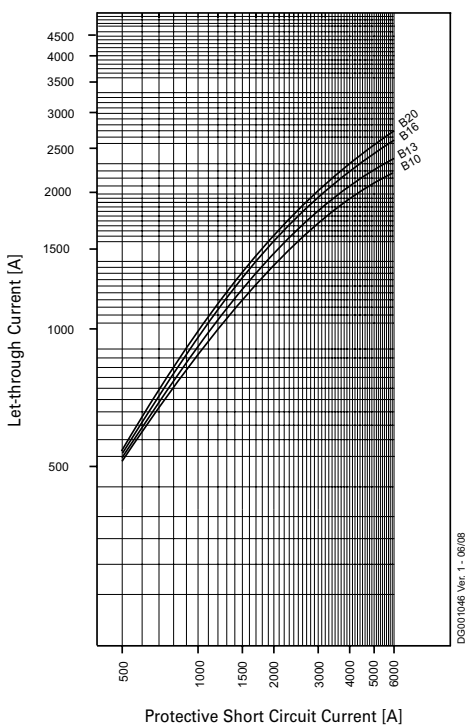

Characteristic C

230V

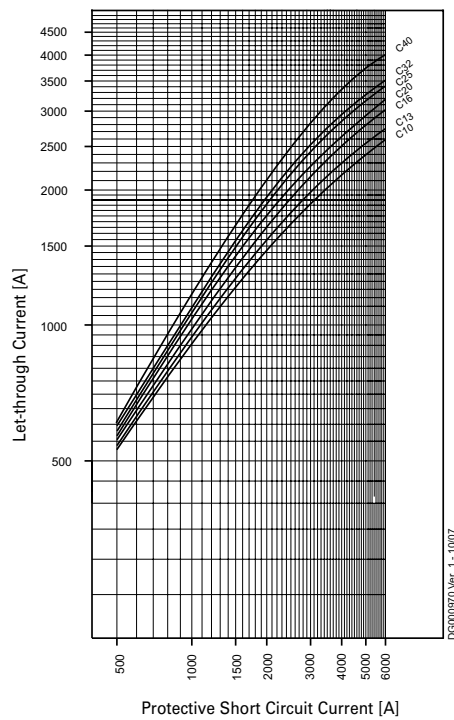

Short-circuit Selectivity FRBmM 2-poles

In case of a short-circuit, selectivity is provided up to the specified selective current values I_s (kA) applicable between the FRBmM RCD/MCB circuit breakers and the up-stream protective devices.

When a short-circuit occurs, this means that with I_{KS} current values below I_s only the MCB will trip. However, in case of short-circuit currents beyond these values both protective devices will trip.

FRBmM 2-poles and NZM1/NZM2

Short circuit currents in kA, rated currents of fuses in A.

Overload and short-circuit release unit NZM at max. value

FRBmM	NZM...1-A...					
	$I_{cu} = 25 (50) \text{ kA}$					
	40	50	63	80	100	125
B10	1.2	1.5	2	2	4	10
B13	1	1.5	2	2	4	10
B16	1	1.2	1.5	2	3	8
B20	0.8	1.2	1.5	1.5	3	8
C10	1.2	1.5	2	2	4	10
C13	1	1.5	2	2	4	10
C16	1	1.2	1.5	2	3	8
C20	0.8	1.2	1.5	1.5	3	8

FRBmM	NZM...2-A...								
	$I_{cu} = 25 (50)(100)(150) \text{ kA}$								
	40	50	63	80	100	125	160	200	250
B10	1	1.5	2.5	3	10	10	10	10	10
B13	1	1.2	2	3	10	10	10	10	10
B16	1	1.2	1.5	2.5	10	10	10	10	10
B20	1	1.2	1.5	1.5	10	10	10	10	10
C10	1	1.5	2.5	3	10	10	10	10	10
C13	1	1.2	2	3	10	10	10	10	10
C16	1	1.2	1.5	2.5	10	10	10	10	10
C20	1	1.2	1.5	1.5	10	10	10	10	10

FRBmM 2-poles and PLSM-OV/PLHT-OV

Short circuit currents in kA, rated currents of fuses in A.

FRBmM	PLSM-OV/PLHT-OV						
	$I_{cu} = 10 \text{ kA}$						
	25	32	40	50	56	63	80
B+C10	1.5	1.5	1.5	1.5	1.5	1.5	1.5
B+C13	1.5	1.5	1.5	1.5	1.5	1.5	1.5
B+C16	1.5	1.5	1.5	1.5	1.5	1.5	1.5
B+C20	-	1.5	1.5	1.5	1.5	1.5	1.5

FRBmM 2-poles and Neozed¹⁾ / Diazed²⁾ / NH00³⁾

Short circuit currents in kA, Rated currents of fuses in A

Short-circuit Selectivity **FRBmM** towards fuse link **Neozed¹⁾**

FRBmM	Neozed ¹⁾									
	16	20	25	32	35	40	50	63	80	100
B10	<0,5	0,5	0,9	2	2,3	3,7	8	10	10	10
B13	<0,5	0,5	0,8	1,7	1,9	3	6	10	10	10
B16	-	0,5	0,7	1,5	1,7	2,4	4,4	6,8	10	10
B20	-	-	0,7	1,4	1,5	2,2	3,9	6	9,2	10
C10	<0,5	0,5	0,8	1,7	1,9	3	6,1	10	10	10
C13	<0,5	0,5	0,7	1,6	1,8	2,8	5,5	9,5	10	10
C16	-	<0,5	0,7	1,3	1,5	2,2	4	6,2	10	10
C20	-	-	0,6	1,3	1,4	2,1	3,7	5,6	8,5	10

Short-circuit Selectivity **FRBmM** towards fuse link **Diazed²⁾**

FRBmM	Diazed ²⁾									
	16	20	25	32	35	50	63	80	100	
B10	<0,5	0,5	0,9	1,8	2,9	5,6	10	10	10	
B13	<0,5	0,5	0,8	1,5	2,4	4,5	10	10	10	
B16	-	0,5	0,8	1,3	2	3,4	8	10	10	
B20	-	-	0,7	1,3	1,9	3,1	7,1	10	10	
C10	<0,5	0,5	0,8	1,5	2,4	4,4	10	10	10	
C13	<0,5	0,5	0,8	1,4	2,3	4,2	10	10	10	
C16	-	<0,5	0,7	1,2	1,9	3,2	7,6	10	10	
C20	-	-	0,7	1,2	1,8	2,9	6,5	9,7	10	

Short-circuit Selectivity **FRBmM** towards fuse link **NH00³⁾**

FRBmM	NH00 ³⁾											
	16	20	25	32	35	40	50	63	80	100	125	160
B10	<0,5	<0,5	0,8	1,5	2,3	3,2	5,7	9,1	10	10	10	10
B13	<0,5	<0,5	0,8	1,3	1,9	2,7	4,4	6,5	10	10	10	10
B16	-	<0,5	0,7	1,1	1,6	2,2	3,4	4,8	8	10	10	10
B20	-	-	0,6	1	1,4	2	3,1	4,3	7	10	10	10
C10	<0,5	<0,5	0,7	1,3	1,9	2,7	4,5	6,9	10	10	10	10
C13	<0,5	<0,5	0,7	1,2	1,8	2,5	4,1	6,1	10	10	10	10
C16	-	<0,5	0,6	1	1,5	2	3,1	4,4	7,5	10	10	10
C20	-	-	0,6	0,9	1,4	1,9	2,9	4,1	6,5	10	10	10

¹⁾ SIEMENS Type 5SE2; Size: D01, D02, D03; Operating class gG; Rated voltage: AC 400 V/DC 250 V

²⁾ SIEMENS Type 5SB2, 5SB4, 5SC2; Size: DII, DIII, DIV; Operating class gG; Rated voltage: AC 500 V/DC 500 V

³⁾ SIEMENS Type 3NA3 8, 3NA6 8, 3NA7 8; Size: 000, 00; Operating class gG; Rated voltage: AC 500 V/DC 250 V

FRBm6 2-poles and NZM1/NZM2

Short circuit currents in kA, rated currents of fuses in A.

Overload and short-circuit release unit NZM at max. value

FRBm6	NZMB(C)(N)(H)1-A...					
	$I_{cu} = 25 (36)(50)(100) \text{ kA}$					
	40	50	63	80	100	125
B10	1	1.3	1.6	1.6	3.5	6
B13	0.9	1.3	1.6	1.6	3.5	6
B16	0.9	1	1.5	1.6	2.5	6
B20	0.6	1	1.3	1.3	2.5	6
B25	0.6	1	1.3	1.3	2.5	6
B32	-	1	0.9	1.3	1.6	5
B40	-	-	0.9	1.3	1.6	4.3
C10	1	1.3	1.6	1.6	3.5	6
C13	0.9	1.3	1.6	1.6	3.5	6
C16	0.9	1	1.5	1.6	2.5	6
C20	0.6	1	1.3	1.3	2.5	6
C25	0.6	1	1.3	1.3	2.5	6
C32	-	1	0.9	1.3	1.6	5
C40	-	-	0.9	1.3	1.6	4.3

FRBm6	NZMB(C)(N)(H)2-A...								
	$I_{cu} = 25 (36)(50)(150) \text{ kA}$								
	40	50	63	80	100	125	160	200	250
B10	0.9	1.3	2.5	2.5	6	6	6	6	6
B13	0.9	1	1.6	2.5	6	6	6	6	6
B16	0.9	1	1.3	2.1	6	6	6	6	6
B20	0.9	1	1.3	1.3	6	6	6	6	6
B25	0.6	0.9	1.3	1.6	6	6	6	6	6
B32	-	0.9	1.3	1.6	6	6	6	6	6
B40	-	-	1	1.3	5	5	5	5	6
C10	0.9	1.3	2.5	2.5	6	6	6	6	6
C13	0.9	1	1.6	2.5	6	6	6	6	6
C16	0.9	1	1.3	2.1	6	6	6	6	6
C20	0.9	1	1.3	1.3	6	6	6	6	6
C25	0.6	0.9	1.3	1.6	6	6	6	6	6
C32	-	0.9	1.3	1.6	6	6	6	6	6
C40	-	-	1	1.3	5	5	5	5	6

FRBm6 2-poles and PLSM-OV/PLHT-OV

Short circuit currents in kA, rated currents of fuses in A.

FRBm6	PLSM-OV/PLHT-OV						
	$I_{cu} = 10 \text{ kA}$						
	25	32	40	50	56	63	80
B+C10	1.5	1.5	1.5	1.5	1.5	1.5	1.5
B+C13	1.5	1.5	1.5	1.5	1.5	1.5	1.5
B+C16	1.5	1.5	1.5	1.5	1.5	1.5	1.5
B+C20	-	1.5	1.5	1.5	1.5	1.5	1.5
B+C25	-	-	1.5	1.5	1.5	1.5	1.5
B+C32	-	-	-	1.5	1.5	1.5	1.5
B+C40	-	-	-	-	1.5	1.5	1.5

FRBm6 2-poles and Neozed¹⁾ / Diazed²⁾ / NH00³⁾

Short circuit currents in kA, Rated currents of fuses in A

Short-circuit Selectivity **FRBm6** towards fuse link **Neozed¹⁾**

FRBm6	Neozed ¹⁾									
	16	20	25	32	35	40	50	63	80	100
B25	-	-	-	1,2	1,3	1,8	3,1	4,7	6	6
B32	-	-	-	-	1,2	1,7	2,7	3,8	5,5	6
B40	-	-	-	-	-	1,3	1,7	2,2	2,7	4,2
C25	-	-	-	1,1	1,3	1,8	2,8	3,9	5,6	6
C32	-	-	-	-	1,2	1,7	2,6	3,6	5,1	6
C40	-	-	-	-	-	1,3	1,9	3,3	3,2	5,8

Short-circuit Selectivity **FRBm6** towards fuse link **Diazed¹⁾**

FRBm6	Diazed ²⁾									
	16	20	25	32	35	50	63	80	100	
B25	-	-	-	1,1	1,5	2,4	5,5	6	6	
B32	-	-	-	-	1,4	2,1	4,3	6	6	
B40	-	-	-	-	-	1,4	2,4	2,9	5,1	
C25	-	-	-	1,1	1,5	2,3	4,4	6	6	
C32	-	-	-	-	1,4	2,2	4,1	5,6	6	
C40	-	-	-	-	-	1,6	2,8	3,6	6	

Short-circuit Selectivity **FRBm6** towards fuse link **NH00³⁾**

FRBm6	NH00 ³⁾											
	16	20	25	32	35	40	50	63	80	100	125	160
B25	-	-	-	0,9	1,2	1,6	2,4	3,4	5,5	6	6	6
B32	-	-	-	-	1,1	1,4	2,1	2,9	4,3	6	6	6
B40	-	-	-	-	-	-	1,4	1,9	2,8	4,1	6	6
C25	-	-	-	0,9	1,2	1,6	2,3	3	4,6	6	6	6
C32	-	-	-	-	1,1	1,5	2,1	2,8	4,3	6	6	6
C40	-	-	-	-	-	-	1,5	2,1	3,1	5,4	6	6

¹⁾ SIEMENS Type 5SE2; Size: D01, D02, D03; Operating class gG; Rated voltage: AC 400 V/DC 250 V

²⁾ SIEMENS Type 5SB2, 5SB4, 5SC2; Size: DII, DIII, DIV; Operating class gG; Rated voltage: AC 500 V/DC 500 V

³⁾ SIEMENS Type 3NA3 8, 3NA6 8, 3NA7 8; Size: 000, 00; Operating class gG; Rated voltage: AC 500 V/DC 250 V

Back-up Protection FRBmM 2-poles

The up-stream protective devices will protect the down-stream FRBmM up to the short-circuit current specified.

FRBmM 2-poles and NZM1

Short circuit currents in kA.

FRBmM	NZMB1
IT-system U = 230 V	
B, C, D	
10	20
13	20
16	20
20	15

$U_e = 230\text{ V}$: I_{cu} (FRBmM2) = 10 kA (acc. to IEC/EN 61009)
 $U_e = 400/415\text{ V}$: I_{cu} (NZMB1) = 25 kA (acc. to IEC/EN 60947-2)

Short circuit currents in kA.

FRBmM	NZMN1
IT-system U = 230 V	
B, C, D	
10	25
13	25
16	25
20	20

$U_e = 230\text{ V}$: I_{cu} (FRBmM2) = 10 kA (acc. to IEC/EN 61009)
 $U_e = 400/415\text{ V}$: I_{cu} (NZMN1) = 50 kA (acc. to IEC/EN 60947-2)

Short circuit currents in kA.

FRBmM	NZMC1
IT-system U = 230 V	
B, C, D	
10	20
13	20
16	20
20	20

$U_e = 230\text{ V}$: I_{cu} (FRBmM2) = 10 kA (acc. to IEC/EN 61009)
 $U_e = 400/415\text{ V}$: I_{cu} (NZMC1) = 36 kA (acc. to IEC/EN 60947-2)

Short circuit currents in kA.

FRBmM	NZMH1
IT-system U = 230 V	
B, C, D	
10	30
13	30
16	30
20	20

$U_e = 230\text{ V}$: I_{cu} (FRBmM2) = 10 kA (acc. to IEC/EN 61009)
 $U_e = 400/415\text{ V}$: I_{cu} (NZMH1) = 100 kA (acc. to IEC/EN 60947-2)

Backup tests acc. to IEC/EN 60947-2, app. A: $U = 1.05 U_e$, (O - t - CO)

FRBmM 2-poles and NZM2

Short circuit currents in kA.

FRBmM	NZMB2
IT-system U = 230 V	
B, C, D	
10	25
13	25
16	25
20	25

$U_e = 230\text{ V}$: I_{cu} (FRBmM2) = 10 kA (acc. to IEC/EN 61009)
 $U_e = 400/415\text{ V}$: I_{cu} (NZMH2) = 25 kA (acc. to IEC/EN 60947-2)

Short circuit currents in kA.

FRBmM	NZMN2
IT-system U = 230 V	
B, C, D	
10	40
13	40
16	40
20	40

$U_e = 230\text{ V}$: I_{cu} (FRBmM2) = 10 kA (acc. to IEC/EN 61009)
 $U_e = 400/415\text{ V}$: I_{cu} (NZMH2) = 50 kA (acc. to IEC/EN 60947-2)

Short circuit currents in kA.

FRBmM	NZMC2
IT-system U = 230 V	
B, C, D	
10	36
13	36
16	36
20	36

$U_e = 230\text{ V}$: I_{cu} (FRBmM2) = 10 kA (acc. to IEC/EN 61009)
 $U_e = 400/415\text{ V}$: I_{cu} (NZMH2) = 36 kA (acc. to IEC/EN 60947-2)

Short circuit currents in kA.

FRBmM	NZMH2
IT-system U = 230 V	
B, C, D	
10	40
13	40
16	40
20	40

$U_e = 230\text{ V}$: I_{cu} (FRBmM2) = 10 kA (acc. to IEC/EN 61009)
 $U_e = 400/415\text{ V}$: I_{cu} (NZMH2) = 100 kA (acc. to IEC/EN 60947-2)

Backup tests acc. to IEC/EN 60947-2, app. A: $U = 1.05 U_e$, (O - t - CO)

FRBmM 2-poles and LZM1

Short circuit currents in kA.

FRBmM	LZMB1
	IT-system U = 230 V
B, C, D	
10	20
13	20
16	20
20	15

$U_e = 230\text{ V}$: I_{cu} (FRBmM2) = 10 kA (acc. to IEC/EN 61009)
 $U_e = 400/415\text{ V}$: I_{cu} (LZMB1) = 25 kA (acc. to IEC/EN 60947-2)

Short circuit currents in kA.

FRBmM	LZMN1
	IT-system U = 230 V
B, C, D	
10	25
13	25
16	25
20	20

$U_e = 230\text{ V}$: I_{cu} (FRBmM2) = 10 kA (acc. to IEC/EN 61009)
 $U_e = 400/415\text{ V}$: I_{cu} (LZMN1) = 50 kA (acc. to IEC/EN 60947-2)

Backup tests acc. to IEC/EN 60947-2, app. A: $U = 1.05 U_e$, (O - t - CO)

Short circuit currents in kA.

FRBmM	LZMC1
	IT-system U = 230 V
B, C, D	
10	20
13	20
16	20
20	20

$U_e = 230\text{ V}$: I_{cu} (FRBmM2) = 10 kA (acc. to IEC/EN 61009)
 $U_e = 400/415\text{ V}$: I_{cu} (LZMC1) = 36 kA (acc. to IEC/EN 60947-2)

Short circuit currents in kA.

FRBmM	LZMS1
	IT-system U = 230 V
B, C, D	
10	30
13	30
16	30
20	20

$U_e = 230\text{ V}$: I_{cu} (FRBmM2) = 10 kA (acc. to IEC/EN 61009)
 $U_e = 400/415\text{ V}$: I_{cu} (LZMS1) = 70 kA (acc. to IEC/EN 60947-2)

FRBmM 2-poles and LZM2

Short circuit currents in kA.

FRBmM	LZMB2
	IT-system U = 230 V
B, C, D	
10	25
13	25
16	25
20	25

$U_e = 230\text{ V}$: I_{cu} (FRBmM2) = 10 kA (acc. to IEC/EN 61009)
 $U_e = 400/415\text{ V}$: I_{cu} (LZMB2) = 25 kA (acc. to IEC/EN 60947-2)

Short circuit currents in kA.

FRBmM	LZMN2
	IT-system U = 230 V
B, C, D	
10	40
13	40
16	40
20	40

$U_e = 230\text{ V}$: I_{cu} (FRBmM2) = 10 kA (acc. to IEC/EN 61009)
 $U_e = 400/415\text{ V}$: I_{cu} (LZMN2) = 50 kA (acc. to IEC/EN 60947-2)

Backup tests acc. to IEC/EN 60947-2, app. A: $U = 1.05 U_e$, (O - t - CO)

Short circuit currents in kA.

FRBmM	LZMC2
	IT-system U = 230 V
B, C, D	
10	36
13	36
16	36
20	36

$U_e = 230\text{ V}$: I_{cu} (FRBmM2) = 10 kA (acc. to IEC/EN 61009)
 $U_e = 400/415\text{ V}$: I_{cu} (LZMC2) = 36 kA (acc. to IEC/EN 60947-2)

Short circuit currents in kA.

FRBmM	LZMS2
	IT-system U = 230 V
B, C, D	
10	40
13	40
16	40
20	40

$U_e = 230\text{ V}$: I_{cu} (FRBmM2) = 10 kA (acc. to IEC/EN 61009)
 $U_e = 400/415\text{ V}$: I_{cu} (LZMS2) = 70 kA (acc. to IEC/EN 60947-2)

FRBmM 2-poles and PLSM-OV, NH00 gG/gL

Short circuit currents in kA.

FRBmM	PLSM-OV63/2, 3, 4, 3N IT-system U = 230 V
B, C, D	
10	10
13	10
16	10
20	10

U_e = 230 V: I_{cu} (FRBmM2) = 10 kA (acc. to IEC/EN 61009)
 U_e = 230/400 V: I_{cn} (PLSM-OV63) = 10 kA (acc. to IEC/EN 60947-2)

Short circuit currents in kA.

FRBmM	NH00 125 A gG/gL IT-system U = 230 V
B, C, D	
10	40
13	40
16	40
20	40

U_e = 230 V: I_{cu} (FRBmM2) = 10 kA (acc. to IEC/EN 61009)
 AC 500 V: (NH00 125A gG/gL) = 120 kA (acc. to IEC60269)

Backup tests acc. to IEC/EN 60947-2, app. A: U = 1.05 U_e, (O - t - CO)

Back-up Protection FRBm6 2-poles

The up-stream protective devices will protect the down-stream FRBm6 up to the short-circuit current specified.

FRBm6 2-poles and NZM1

Short circuit currents in kA.

FRBm6	NZMB1-A...
	IT-system U = 230 V
B, C, D	
10	20
13	20
16	20
20	15
25	15
32	15
40	15

$U_e = 230\text{ V}$: I_{cu} (FRBm62) = 6 kA (acc. to IEC/EN 61009)

$U_e = 400/415\text{ V}$: I_{cu} (NZMB1) = 25 kA (acc. to IEC/EN 60947-2)

Short circuit currents in kA.

FRBm6	NZMN1-A...
	IT-system U = 230 V
B, C, D	
10	25
13	25
16	25
20	20
25	20
32	20
40	20

$U_e = 230\text{ V}$: I_{cu} (FRBm62) = 6 kA (acc. to IEC/EN 61009)

$U_e = 400/415\text{ V}$: I_{cu} (NZMN1) = 50 kA (acc. to IEC/EN 60947-2)

Backup tests acc. to IEC/EN 60947-2, app. A: $U = 1.05 U_e$, (O - t - CO)

Short circuit currents in kA.

FRBm6	NZMC1-A...
	IT-system U = 230 V
B, C, D	
10	20
13	20
16	20
20	20
25	20
32	20
40	20

$U_e = 230\text{ V}$: I_{cu} (FRBm62) = 6 kA (acc. to IEC/EN 61009)

$U_e = 400/415\text{ V}$: I_{cu} (NZMC1) = 36 kA (acc. to IEC/EN 60947-2)

Short circuit currents in kA.

FRBm6	NZMH1-A...
	IT-system U = 230 V
B, C, D	
10	20
13	20
16	20
20	15
25	15
32	15
40	15

$U_e = 230\text{ V}$: I_{cu} (FRBm62) = 6 kA (acc. to IEC/EN 61009)

$U_e = 400/415\text{ V}$: I_{cu} (NZMH1) = 100 kA (acc. to IEC/EN 60947-2)

FRBm6 2-poles and NZM2

Short circuit currents in kA.

FRBm6	NZMB2-A...
	IT-system U = 230 V
B, C, D	
10	20
13	20
16	20
20	15
25	15
32	15
40	10

$U_e = 230\text{ V}$: I_{cu} (FRBm62) = 6 kA (acc. to IEC/EN 61009)

$U_e = 400/415\text{ V}$: I_{cu} (NZMB2) = 25 kA (acc. to IEC/EN 60947-2)

Short circuit currents in kA.

FRBm6	NZMN2-A...
	IT-system U = 230 V
B, C, D	
10	30
13	30
16	30
20	20
25	20
32	20
40	10

$U_e = 230\text{ V}$: I_{cu} (FRBm62) = 6 kA (acc. to IEC/EN 61009)

$U_e = 400/415\text{ V}$: I_{cu} (NZMN2) = 50 kA (acc. to IEC/EN 60947-2)

Backup tests acc. to IEC/EN 60947-2, app. A: $U = 1.05 U_e$, (O - t - CO)

Short circuit currents in kA.

FRBm6	NZMC2-A...
	IT-system U = 230 V
B, C, D	
10	25
13	25
16	25
20	20
25	20
32	20
40	10

$U_e = 230\text{ V}$: I_{cu} (FRBm62) = 6 kA (acc. to IEC/EN 61009)

$U_e = 400/415\text{ V}$: I_{cu} (NZMC2) = 36 kA (acc. to IEC/EN 60947-2)

Short circuit currents in kA.

FRBm6	NZMH2-A...
	IT-system U = 230 V
B, C, D	
10	30
13	30
16	30
20	25
25	25
32	25
40	10

$U_e = 230\text{ V}$: I_{cu} (FRBm62) = 6 kA (acc. to IEC/EN 61009)

$U_e = 400/415\text{ V}$: I_{cu} (NZMH2) = 100 kA (acc. to IEC/EN 60947-2)

FRBm6 2-poles and LZM1

Short circuit currents in kA.

FRBm6	LZMB1-A... IT-system U = 230 V
B, C, D	
10	20
13	20
16	20
20	15
25	15
32	15
40	15

$U_e = 230\text{ V}$: I_{cu} (FRBm62) = 6 kA (acc. to IEC/EN 61009)
 $U_e = 400/415\text{ V}$: I_{cu} (LZMB1) = 25 kA (acc. to IEC/EN 60947-2)

Short circuit currents in kA.

FRBm6	LZMN1-A... IT-system U = 230 V
B, C, D	
10	25
13	25
16	25
20	20
25	20
32	20
40	20

$U_e = 230\text{ V}$: I_{cu} (FRBm62) = 6 kA (acc. to IEC/EN 61009)
 $U_e = 400/415\text{ V}$: I_{cu} (LZMN1) = 50 kA (acc. to IEC/EN 60947-2)

Backup tests acc. to IEC/EN 60947-2, app. A: $U = 1.05 U_e$, (O - t - CO)

Short circuit currents in kA.

FRBm6	LZMC1-A... IT-system U = 230 V
B, C, D	
10	20
13	20
16	20
20	20
25	20
32	20
40	20

$U_e = 230\text{ V}$: I_{cu} (FRBm62) = 6 kA (acc. to IEC/EN 61009)
 $U_e = 400/415\text{ V}$: I_{cu} (LZMC1) = 36 kA (acc. to IEC/EN 60947-2)

Short circuit currents in kA.

FRBm6	LZMS1-A... IT-system U = 230 V
B, C, D	
10	30
13	30
16	30
20	20
25	20
32	20
40	20

$U_e = 230\text{ V}$: I_{cu} (FRBm62) = 6 kA (acc. to IEC/EN 61009)
 $U_e = 400/415\text{ V}$: I_{cu} (LZMS1) = 70 kA (acc. to IEC/EN 60947-2)

FRBm6 2-poles and LZM2

Short circuit currents in kA.

FRBm6	LZMB2-A... IT-system U = 230 V
B, C, D	
10	20
13	20
16	20
20	15
25	15
32	15
40	10

$U_e = 230\text{ V}$: I_{cu} (FRBm62) = 6 kA (acc. to IEC/EN 61009)
 $U_e = 400/415\text{ V}$: I_{cu} (LZMB2) = 25 kA (acc. to IEC/EN 60947-2)

Short circuit currents in kA.

FRBm6	LZMN2-A... IT-system U = 230 V
B, C, D	
10	25
13	25
16	25
20	20
25	20
32	20
40	20

$U_e = 230\text{ V}$: I_{cu} (FRBm62) = 6 kA (acc. to IEC/EN 61009)
 $U_e = 400/415\text{ V}$: I_{cu} (LZMN2) = 50 kA (acc. to IEC/EN 60947-2)

Backup tests acc. to IEC/EN 60947-2, app. A: $U = 1.05 U_e$, (O - t - CO)

Short circuit currents in kA.

FRBm6	LZMC2-A... IT-system U = 230 V
B, C, D	
10	20
13	20
16	20
20	20
25	20
32	20
40	20

$U_e = 230\text{ V}$: I_{cu} (FRBm62) = 6 kA (acc. to IEC/EN 61009)
 $U_e = 400/415\text{ V}$: I_{cu} (LZMC2) = 36 kA (acc. to IEC/EN 60947-2)

Short circuit currents in kA.

FRBm6	LZMS2-A... IT-system U = 230 V
B, C, D	
10	30
13	30
16	30
20	20
25	20
32	20
40	20

$U_e = 230\text{ V}$: I_{cu} (FRBm62) = 6 kA (acc. to IEC/EN 61009)
 $U_e = 400/415\text{ V}$: I_{cu} (LZMS2) = 70 kA (acc. to IEC/EN 60947-2)

FRBm6 2-poles and PLSM-OV, NH00 gG/gL

Short circuit currents in kA.

FRBm6	PLSM-OV63/2, 3, 4, 3N
	IT-system U = 230 V
B, C, D	
10	10
13	10
16	10
20	10
25	10
32	10
40	10

U_e = 230 V: I_{cu} (FRBm62) = 6 kA (acc. to IEC/EN 61009)U_e = 230/400 V: I_{cn} PLSM-OV63) = 10 kA (acc. to IEC/EN 60947-2)

Short circuit currents in kA.

FRBm6	NH00 100 A gG/gL
	IT-system U = 230 V
B, C, D	
10	40
13	40
16	40
20	40
25	40
32	40
40	40

U_e = 230 V: I_{cu} (FRBm62) = 6 kA (acc. to IEC/EN 61009)

AC 500 V: (NH00 125A gG/gL) = 120 kA (acc. to IEC60269)

Backup tests acc. to IEC/EN 60947-2, app. A: U = 1.05 U_e, (O - t - CO)

SG02013



Description

- High-quality residual current device / miniature circuit breaker combination, line voltage-independent
- Contact position indicator red - green
- Fault current tripping indicator white - blue
- Guide for secure terminal connection
- 3-position DIN rail clip, permits removal from existing busbar system
- Comprehensive range of accessories suitable for subsequent installation
- Wide variety of rated tripping currents
- Rated currents up to 32 A
- Tripping characteristics B, C, D
- Rated breaking capacity acc. to IEC/EN 61009 10kA
- Rated breaking capacity acc. to IEC/EN 60947-2 15kA
- Classified for the use in rail rolling stock

1.134 Combined RCD/MCB Devices

Combined RCD/MCB Devices FRBmM 3-poles

$I_n/I_{\Delta n}$
(A)

Type
Designation

Article No. Units per
package

Type A

3-poles

Conditionally surge current-proof 250 A, sensitive to residual pulsating DC, Type A 

SG02013



Characteristic B

10/0.03	FRBmM-B10/3/003-A	170733	1/30
13/0.03	FRBmM-B13/3/003-A	170734	1/30
16/0.03	FRBmM-B16/3/003-A	170735	1/30
20/0.03	FRBmM-B20/3/003-A	170736	1/30
10/0.1	FRBmM-B10/3/01-A	170780	1/30
13/0.1	FRBmM-B13/3/01-A	170781	1/30
16/0.1	FRBmM-B16/3/01-A	170782	1/30
20/0.1	FRBmM-B20/3/01-A	170783	1/30

SG02013



Characteristic C

6/0.03	FRBmM-C6/3/003-A	170737	1/30
10/0.03	FRBmM-C10/3/003-A	170738	1/30
13/0.03	FRBmM-C13/3/003-A	170739	1/30
16/0.03	FRBmM-C16/3/003-A	170740	1/30
20/0.03	FRBmM-C20/3/003-A	170741	1/30
25/0.03	FRBmM-C25/3/003-A	170772	1/30
32/0.03	FRBmM-C32/3/003-A	170773	1/30
6/0.1	FRBmM-C6/3/01-A	170742	1/30
10/0.1	FRBmM-C10/3/01-A	170743	1/30
13/0.1	FRBmM-C13/3/01-A	170744	1/30
16/0.1	FRBmM-C16/3/01-A	170745	1/30
20/0.1	FRBmM-C20/3/01-A	170746	1/30
25/0.1	FRBmM-C25/3/01-A	170747	1/30
32/0.1	FRBmM-C32/3/01-A	170748	1/30

SG02013



Characteristic D

6/0.03	FRBmM-D6/3/003-A	170774	1/30
10/0.03	FRBmM-D10/3/003-A	170775	1/30
13/0.03	FRBmM-D13/3/003-A	170776	1/30
16/0.03	FRBmM-D16/3/003-A	170777	1/30
20/0.03	FRBmM-D20/3/003-A	170778	1/30
25/0.03	FRBmM-D25/3/003-A	170779	1/30
6/0.1	FRBmM-D6/3/01-A	170749	1/30
10/0.1	FRBmM-D10/3/01-A	170750	1/30
13/0.1	FRBmM-D13/3/01-A	170751	1/30
16/0.1	FRBmM-D16/3/01-A	170752	1/30
20/0.1	FRBmM-D20/3/01-A	170753	1/30
25/0.1	FRBmM-D25/3/01-A	170754	1/30

SG02013



Description

- A range of residual current device / miniature circuit breaker combination for a wide range of applications with the added benefit of accepting cables fitted with Ring Tongue connections - as used on applications such as Rail rolling stock etc.
- Line voltage independent
- Contact position indicator red - green
- Fault current tripping indicator white - blue
- Guide for secure terminal connection
- 3-position DIN rail clip, permits removal from existing busbar system
- Comprehensive range of accessories suitable for subsequent installation
- Wide variety of rated tripping currents
- Rated currents up to 32 A
- Tripping characteristics B, C, D
- Rated breaking capacity acc. to IEC/EN 61009 10 kA
- Rated breaking capacity acc. to IEC/EN 60947-2 up to 15 kA
- Classified for the use in rail rolling stock

$I_n/I_{\Delta n}$
(A)

Type
Designation

Article No.

Units per
package

Type A

10 kA, 3-poles

Conditionally surge current-proof 250 A, sensitive to residual pulsating DC, Type A

SG02013



Characteristic B

$I_n/I_{\Delta n}$ (A)	Type Designation	Article No.	Units per package
10/003	FRBMM-B10/3/003-A-RT	305151	1/30
13/003	FRBMM-B13/3/003-A-RT	305152	1/30
16/003	FRBMM-B16/3/003-A-RT	305153	1/30
20/003	FRBMM-B20/3/003-A-RT	305154	1/30

SG02013



Characteristic C

$I_n/I_{\Delta n}$ (A)	Type Designation	Article No.	Units per package
6/003	FRBMM-C6/3/003-A-RT	305157	1/30
10/003	FRBMM-C10/3/003-A-RT	305158	1/30
13/003	FRBMM-C13/3/003-A-RT	305159	1/30
16/003	FRBMM-C16/3/003-A-RT	305161	1/30
20/003	FRBMM-C20/3/003-A-RT	305162	1/30
25/003	FRBMM-C25/3/003-A-RT	305163	1/30
32/003	FRBMM-C32/3/003-A-RT	305164	1/30

SG02013



Characteristic D

$I_n/I_{\Delta n}$ (A)	Type Designation	Article No.	Units per package
6/003	FRBMM-D6/3/003-A-RT	305165	1/30
10/003	FRBMM-D10/3/003-A-RT	305166	1/30
13/003	FRBMM-D13/3/003-A-RT	305167	1/30
16/003	FRBMM-D16/3/003-A-RT	305168	1/30
20/003	FRBMM-D20/3/003-A-RT	305169	1/30
25/003	FRBMM-D25/3/003-A-RT	305170	1/30

Specifications | Combined RCD/MCB Devices FRBmM, 3-poles

Description

- Combined RCD/MCB device
- Line voltage-independent tripping
- Compatible with standard busbar
- Twin-purpose terminal (lift/open-mouthed) above and below
- Busbar positioning optionally above or below
- Free terminal space despite installed busbar
- Guide for secure terminal connection
- Contact position indicator red - green
- Fault current tripping indicator white - blue
- Comprehensive range of accessories suitable for subsequent installation
- The test key "T" must be pressed every 6 months. The system operator must be informed of this obligation and his responsibility in a way that can be proven. Under special conditions (e.g. damply and/or dusty environments, environments with polluting and/or corroding conditions, environments with large temperature fluctuations, installations with a risk of overvoltages due to switching of equipment and/or atmospheric discharges, portable equipment ...), it's recommended to test in monthly intervals.
- Pressing the test key "T" serves the only purpose of function testing the residual current device (RCD). This test does not make earthing resistance measurement (R_E), or proper checking of the earth conductor condition redundant, which must be performed separately.
- **Type -A:** Protects against special forms of residual pulsating DC which have not been smoothed.
- **Type -G:** High reliability against unwanted tripping. Suitable any circuit where personal injury or damage to property may occur in case of unwanted tripping.

Accessories:

Auxiliary switch for subsequent installation	ZP-IHK	286052
	ZP-WHK	286053
Tripping signal switch for subsequent installation	ZP-NHK	248437
Shunt trip release	ZP-ASA/..	248438, 248439
Terminal cover 4-poles	Z-TC/SD-4P	178101

Technical Data

		FRBmM, 3-poles
Electrical		
Design according to		IEC/EN 61009, IEC60947-2
Classified according to		IEC 61373, EN 45545-2
Current test marks as printed onto the device		
Tripping line voltage-independent		instantaneous 250A (8/20µs), surge current-proof
Type G		10 ms delay, surge current-proof
Rated voltage	U_n	30 mA types: 415 V AC; 50 Hz 100 mA types: 240/415 V AC; 50 Hz
Rated tripping current	$I_{\Delta n}$	30, 100 mA
Rated non-tripping current	$I_{\Delta no}$	0.5 $I_{\Delta n}$
Sensitivity		AC and pulsating DC
Selectivity class		3
Rated short circuit capacity (acc. to IEC/EN 61009)	I_{cn}	10 kA
Rated short circuit capacity (acc. to IEC/EN 60947-2)	I_{cu}	15 kA
Short-circuit breaking capacity (acc. to IEC/EN60947-2)	I_{cs}	6 kA
Rated current (acc. to IEC/EN 61009)		6 - 32 A
Rated impulse withstand voltage	U_{imp}	4 kV (1.2/50µs)
Characteristic		B, C, D
Maximum back-up fuse (short circuit protection)		100 A gL (>10 kA)
Endurance		
electrical components		≥ 4,000 operating cycles
mechanical components		≥ 10,000 operating cycles
Mechanical		
Frame size		45 mm
Device height		80 mm
Device width		70 mm (4MU)
Mounting		3-position DIN rail clip, permits removal from existing busbar system
Degree of protection switch		IP20
Degree of protection, built-in		IP40
Upper and lower terminals		open mouthed/lift terminals
Terminal protection		finger and hand touch safe, DGUV VS3, EN 50274
Terminal capacity		1 - 25 mm ²
Terminal torque		2 - 2.4 Nm
Busbar thickness		0.8 - 2 mm
Operation temperature		-25°C to +40°C
Storage- and transport temperature		-35°C to +60°C
Resistance to climatic conditions		acc. to IEC 68-2 (25..55°C / 90..95% RH)

Connection diagram

3-poles

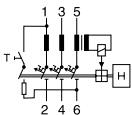

Dimensions (mm)

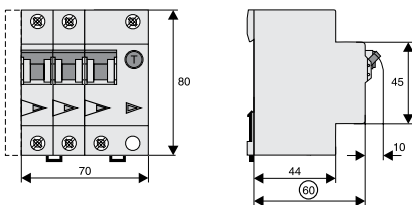

Connection of ring cable lugs (only FRB...RT)

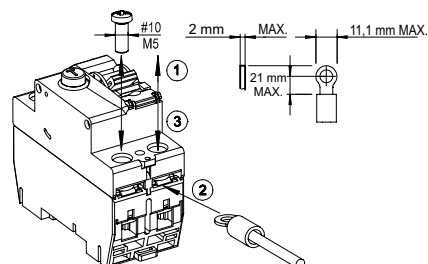

Tripping Characteristic FRBmM 3-poles, Characteristics B, C and D

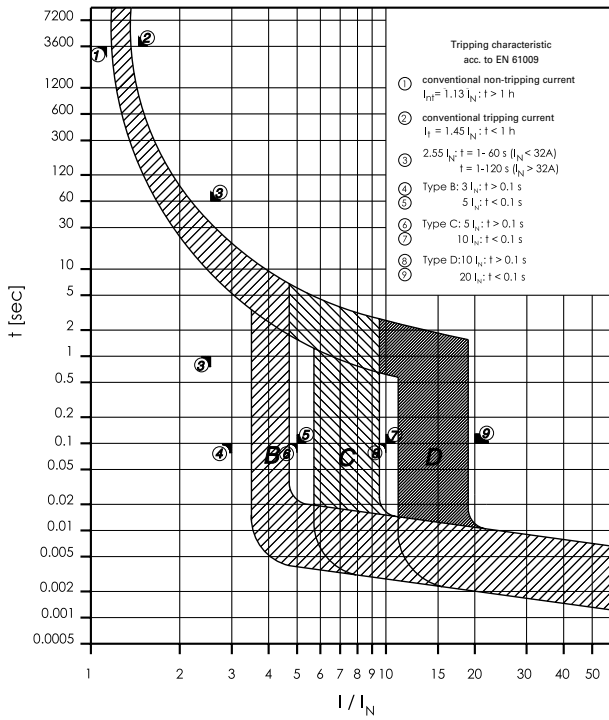

Internal Resistance FRBmM 3-poles

	Type B	Type C	Type D
At room temperature (single pole)			
I_n [A]	Z^* [mΩ]	Z^* [mΩ]	Z^* [mΩ]
6	-	34	34
10	22	56	20
13	38	31	9.8
16	28	27	9.3
20	7.4	6.4	6.6
25	-	4.2	3.9
32	-	3.1	-

* 50Hz

Power Loss at I_n FRBmM 3-poles

	Type B	Type C	Type D
(entire unit)			
I_n [A]	P^* [W]	P^* [W]	P^* [W]
6	-	4.0	4.0
10	7.6	6.3	6.5
13	8.9	9.0	5.9
16	8.3	8.6	9.0
20	11.3	9.2	9.7
25	-	9.4	9.2
32	-	12.8	-

* 50Hz

Maximale Let-through Energy FRBmM 3-poles

Type B

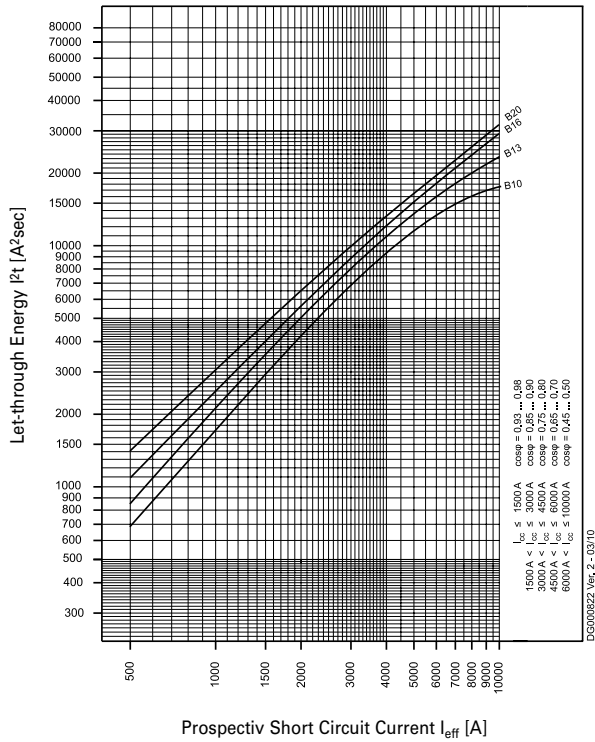

Type C

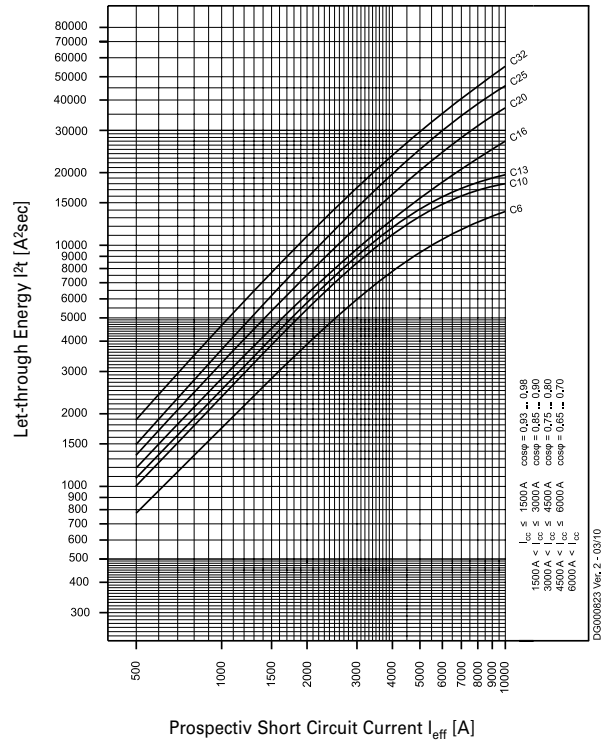

Type D

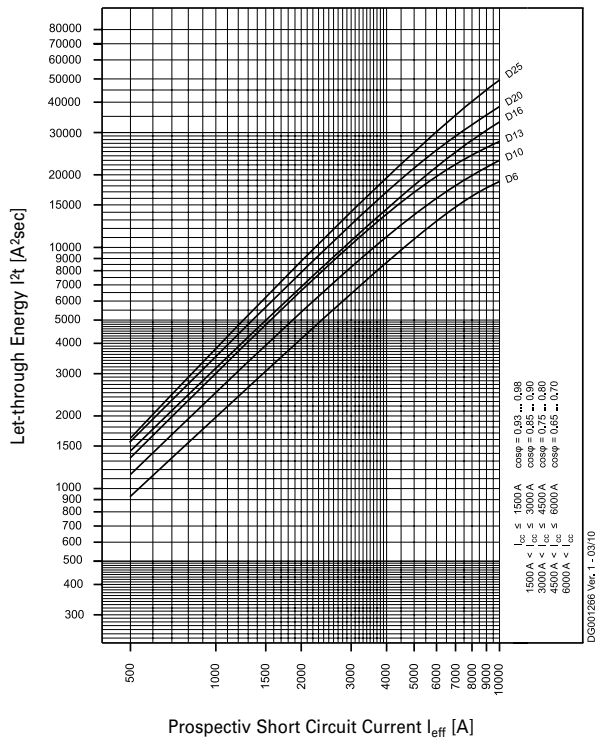

Maximaler Let-through Current FRBmM 3-poles

Type B

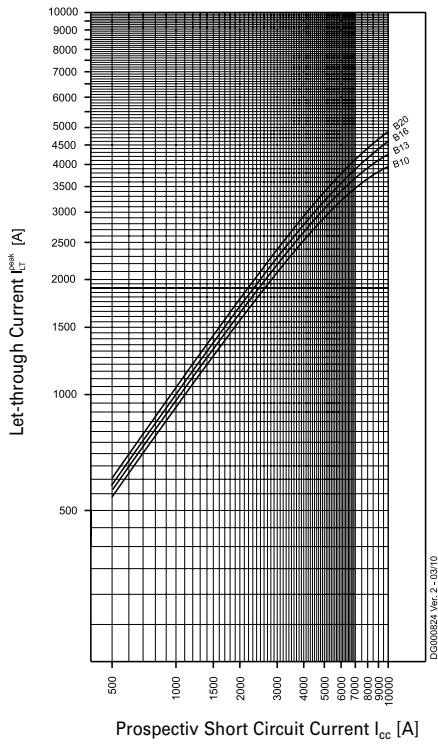

Type C

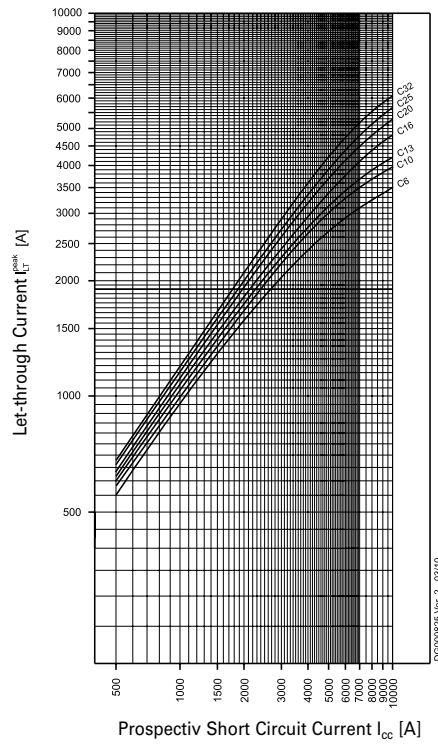

Type D

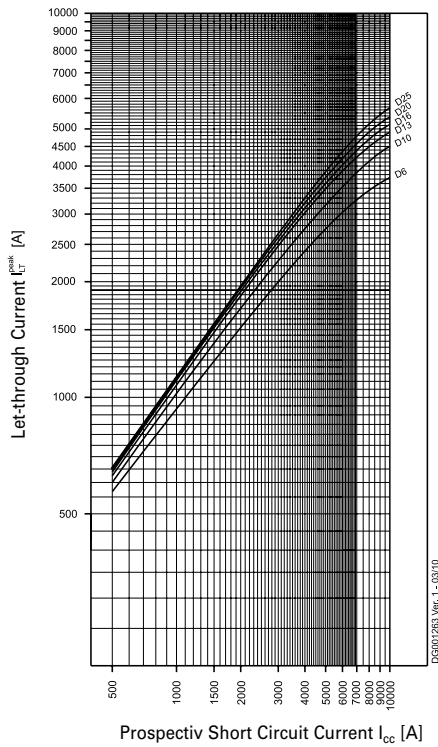

Short-circuit Selectivity FRBmM, 3-poles

In case of a short-circuit, selectivity is provided up to the specified selective current values I_s (kA) applicable between the FRBmM RCD/MCB circuit breakers and the up-stream protective devices.

When a short-circuit occurs, this means that with I_{KS} current values below I_s only the MCB will trip. However, in case of short-circuit currents beyond these values both protective devices will trip.

FRBmM, 3-poles, Characteristic B and NZM 1/2



NZM

FRBmM-B

Selectivity-limit current I_s [kA] for selectivity between FRBmM-.../B and NZM (overload and short-circuit release unit NZM at max. value).

FRBmM-B	NZM...1-A...					
	$I_{cu} = 25(36)(50)(100)$ kA bei $U_e = 400/415$ V					
I_n [A]	40	50	63	80	100	125
10	1.2	1.5	2	2	4	10
13	1	1.5	2	2	4	10
16	1	1.2	1.5	2	3	8
20	0.8	1.2	1.5	1.5	3	8

FRBmM-B	NZM...2-A...									
	$I_{cu} = 25(36)(50)(150)$ kA bei $U_e = 400/415$ V									
I_n [A]	40	50	63	80	100	125	160	200	250	
10	1	1.5	2.5	3	10	10	10	10	10	
13	1	1.2	2	3	10	10	10	10	10	
16	1	1.2	1.5	2.5	10	10	10	10	10	
20	1	1.2	1.5	1.5	10	10	10	10	10	

FRBmM, 3-poles, Characteristic C and NZM 1/2



NZM

FRBmM-C

Selectivity-limit current I_s [kA] for selectivity between FRBmM-.../C and NZM (overload and short-circuit release unit NZM at max. value).

FRBmM-C	NZM...1-A...					
	$I_{cu} = 25(36)(50)(100)$ kA bei $U_e = 400/415$ V					
I_n [A]	40	50	63	80	100	125
6	1.2	2	2.5	3	5	10
10	1.2	1.5	2	2	4	10
13	1	1.5	2	2	4	10
16	1	1.2	1.5	2	3	8
20	0.8	1.2	1.5	1.5	3	8
25	0.7	1.2	1.5	1.5	3	7
32	-	1.2	1	1.5	2	6

FRBmM-C	NZM...2-A...									
	$I_{cu} = 25(36)(50)(150)$ kA bei $U_e = 400/415$ V									
I_n [A]	40	50	63	80	100	125	160	200	250	
6	1.2	1.5	2.5	3	10	10	10	10	10	
10	1	1.5	2.5	3	10	10	10	10	10	
13	1	1.2	2	3	10	10	10	10	10	
16	1	1.2	1.5	2.5	10	10	10	10	10	
20	1	1.2	1.5	1.5	10	10	10	10	10	
25	0.8	1	1.5	2	10	10	10	10	10	
32	-	1	1.5	2	6	6	6	6	6	

FRBmM, 3-poles, Characteristic D and NZM 1/2



NZM

FRBmM-D

Selectivity-limit current I_s [kA] for selectivity between FRBmM-.../D and NZM (overload and short-circuit release unit NZM at max. value).

FRBmM-D	NZM...1-A...					
	$I_{cu} = 25(36)(50)(100)$ kA bei $U_e = 400/415$ V					
I_n [A]	40	50	63	80	100	125
6	1.2	2	2.5	3	5	10
10	1.2	1.5	2	2	4	10
13	1	1.5	2	2	4	10
16	1	1.2	1.5	2	3	8
20	0.8	1.2	1.5	1.5	3	8
25	0.7	1.2	1.5	1.5	3	7

FRBmM-D	NZM...2-A...									
	$I_{cu} = 25(36)(50)(150)$ kA bei $U_e = 400/415$ V									
I_n [A]	40	50	63	80	100	125	160	200	250	
6	1.2	1.5	2.5	3	10	10	10	10	10	
10	1	1.5	2.5	3	10	10	10	10	10	
13	1	1.2	2	3	10	10	10	10	10	
16	1	1.2	1.5	2.5	10	10	10	10	10	
20	1	1.2	1.5	1.5	10	10	10	10	10	
25	0.8	1	1.5	2	10	10	10	10	10	

Back-up Protection FRBmM 3-poles

The up-stream protective devices will protect the down-stream FRBmM up to the short-circuit current specified.

FRBmM 3-poles and NZMB(C)(N)(H)1

FRBmM 3-poles and NZMB1

$U_e = 133 / 230 \text{ V}$

FRBmM	NZMB1 $I_n/3/B(C)(D)/003(01)(03)$		
	Type B	Type C	Type D
6	-	25kA	25kA
10	25kA	25kA	25kA
13	25kA	25kA	25kA
16	25kA	25kA	25kA
20	25kA	25kA	25kA
25	-	25kA	25kA
32	-	25kA	-

FRBmM 3-poles and NZMC1

$U_e = 133 / 230 \text{ V}$

FRBmM	NZMC1 $I_n/3/B(C)(D)/003(01)(03)$		
	Type B	Type C	Type D
6	-	36kA	36kA
10	36kA	36kA	36kA
13	36kA	36kA	36kA
16	36kA	36kA	36kA
20	36kA	36kA	36kA
25	-	36kA	36kA
32	-	36kA	-

FRBmM 3-poles and NZMN1

$U_e = 133 / 230 \text{ V}$

FRBmM	NZMN1 $I_n/3/B(C)(D)/003(01)(03)$		
	Type B	Type C	Type D
6	-	50kA	50kA
10	50kA	50kA	50kA
13	50kA	50kA	50kA
16	50kA	50kA	50kA
20	50kA	50kA	50kA
25	-	50kA	50kA
32	-	50kA	-

FRBmM 3-poles and NZMH1

$U_e = 133 / 230 \text{ V}$

FRBmM	NZMH1 $I_n/3/B(C)(D)/003(01)(03)$		
	Type B	Type C	Type D
6	-	70kA	70kA
10	70kA	70kA	70kA
13	70kA	70kA	70kA
16	70kA	70kA	70kA
20	70kA	70kA	70kA
25	-	70kA	70kA
32	-	70kA	-

FRBmM 3-poles and NZMB(C)(N)(H)2

FRBmM 3-poles and NZMB2

$U_e = 133 / 230 \text{ V}$

FRBmM	NZMB2 $I_n/3/B(C)(D)/003(01)(03)$		
	Type B	Type C	Type D
6	-	25kA	25kA
10	25kA	25kA	25kA
13	25kA	25kA	25kA
16	25kA	25kA	25kA
20	25kA	25kA	25kA
25	-	25kA	25kA
32	-	25kA	-

FRBmM 3-poles and NZMC2

$U_e = 133 / 230 \text{ V}$

FRBmM	NZMC2 $I_n/3/B(C)(D)/003(01)(03)$		
	Type B	Type C	Type D
6	-	36kA	36kA
10	36kA	36kA	36kA
13	36kA	36kA	36kA
16	36kA	36kA	36kA
20	36kA	36kA	36kA
25	-	36kA	36kA
32	-	36kA	-

FRBmM 3-poles and NZMN2

$U_e = 133 / 230 \text{ V}$

FRBmM	NZMN2 $I_n/3/B(C)(D)/003(01)(03)$		
	Type B	Type C	Type D
6	-	50kA	50kA
10	50kA	50kA	50kA
13	50kA	50kA	50kA
16	50kA	50kA	50kA
20	50kA	50kA	50kA
25	-	50kA	50kA
32	-	50kA	-

FRBmM 3-poles and NZMH2

$U_e = 133 / 230 \text{ V}$

FRBmM	NZMH2 $I_n/3/B(C)(D)/003(01)(03)$		
	Type B	Type C	Type D
6	-	70kA	70kA
10	70kA	70kA	70kA
13	70kA	70kA	70kA
16	70kA	70kA	70kA
20	70kA	70kA	70kA
25	-	70kA	70kA
32	-	70kA	-

FRBmM 3-poles and NH00**FRBmM 3-poles and NH00 125A gG/gL**

$U_g = 133 / 230 \text{ V}$

FRBmM	NH00 125A gG/gL		
	$I_n/3/B(C)(D)/003(01)(03)$		
	Type B	Type C	Type D
6	-	70kA	70kA
10	70kA	70kA	70kA
13	70kA	70kA	70kA
16	70kA	70kA	70kA
20	70kA	70kA	70kA
25	-	70kA	70kA
32	-	70kA	-

SG02213



Description

- High-quality residual current device / miniature circuit breaker combination, line voltage-independent
- Contact position indicator red - green
- Fault current tripping indicator white - blue
- Guide for secure terminal connection
- 3-position DIN rail clip, permits removal from existing busbar system
- Comprehensive range of accessories suitable for subsequent installation
- Wide variety of rated tripping currents
- Rated currents up to 32 A
- Tripping characteristics B, C, D
- Rated breaking capacity 6 kA or 4.5 kA acc. to IEC/EN 61009 & IEC/EN 60947
- Classified for the use in rail rolling stock

$I_n/I_{\Delta n}$
(A)

Type
Designation

Article No.

Units per
package

Type A

6 kA, 3+N-poles

Conditionally surge current-proof 250 A, sensitive to residual pulsating DC, Type A 

SG02213



Characteristic B

$I_n/I_{\Delta n}$ (A)	Type Designation	Article No.	Units per package
13/0.03	FRBm6-B13/3N/003-A	170987	1/30
16/0.03	FRBm6-B16/3N/003-A	170988	1/30
13/0.1	FRBm6-B13/3N/01-A	170898	1/30
16/0.1	FRBm6-B16/3N/01-A	170899	1/30
13/0.3	FRBm6-B13/3N/03-A	170945	1/30
16/0.3	FRBm6-B16/3N/03-A	170946	1/30

SG02213



Characteristic C

$I_n/I_{\Delta n}$ (A)	Type Designation	Article No.	Units per package
6/0.03	FRBm6-C6/3N/003-A	170996	1/30
10/0.03	FRBm6-C10/3N/003-A	170997	1/30
13/0.03	FRBm6-C13/3N/003-A	170998	1/30
16/0.03	FRBm6-C16/3N/003-A	170999	1/30
6/0.1	FRBm6-C6/3N/01-A	170926	1/30
10/0.1	FRBm6-C10/3N/01-A	170927	1/30
13/0.1	FRBm6-C13/3N/01-A	170928	1/30
16/0.1	FRBm6-C16/3N/01-A	170929	1/30
6/0.3	FRBm6-C6/3N/03-A	170954	1/30
10/0.3	FRBm6-C10/3N/03-A	170955	1/30
13/0.3	FRBm6-C13/3N/03-A	170956	1/30
16/0.3	FRBm6-C16/3N/03-A	170957	1/30

SG02213



Characteristic D

$I_n/I_{\Delta n}$ (A)	Type Designation	Article No.	Units per package
6/0.03	FRBm6-D6/3N/003-A	171008	1/30
10/0.03	FRBm6-D10/3N/003-A	170892	1/30
13/0.03	FRBm6-D13/3N/003-A	170893	1/30
16/0.03	FRBm6-D16/3N/003-A	170894	1/30
6/0.1	FRBm6-D6/3N/01-A	170938	1/30
10/0.1	FRBm6-D10/3N/01-A	170939	1/30
13/0.1	FRBm6-D13/3N/01-A	170940	1/30
16/0.1	FRBm6-D16/3N/01-A	170941	1/30
6/0.3	FRBm6-D6/3N/03-A	170966	1/30
10/0.3	FRBm6-D10/3N/03-A	170967	1/30
13/0.3	FRBm6-D13/3N/03-A	170968	1/30
16/0.3	FRBm6-D16/3N/03-A	170969	1/30

$I_n/I_{\Delta n}$
(A)

Type
Designation

Article No. Units per
package

Type AC

6 kA, 3+N-poles

Conditionally surge current-proof 250 A, Type AC 

SG02213



Characteristic B

$I_n/I_{\Delta n}$ (A)	Type Designation	Article No.	Units per package
13/0.03	FRBm6-B13/3N/003	170985	1/30
16/0.03	FRBm6-B16/3N/003	170986	1/30
13/0.1	FRBm6-B13/3N/01	170896	1/30
16/0.1	FRBm6-B16/3N/01	170897	1/30
13/0.3	FRBm6-B13/3N/03	170943	1/30
16/0.3	FRBm6-B16/3N/03	170944	1/30

SG02213



Characteristic C

$I_n/I_{\Delta n}$ (A)	Type Designation	Article No.	Units per package
6/0.03	FRBm6-C6/3N/003	170989	1/30
10/0.03	FRBm6-C10/3N/003	170990	1/30
13/0.03	FRBm6-C13/3N/003	170991	1/30
16/0.03	FRBm6-C16/3N/003	170992	1/30
6/0.1	FRBm6-C6/3N/01	170900	1/30
10/0.1	FRBm6-C10/3N/01	170901	1/30
13/0.1	FRBm6-C13/3N/01	170902	1/30
16/0.1	FRBm6-C16/3N/01	170903	1/30
6/0.3	FRBm6-C6/3N/03	170947	1/30
10/0.3	FRBm6-C10/3N/03	170948	1/30
13/0.3	FRBm6-C13/3N/03	170949	1/30
16/0.3	FRBm6-C16/3N/03	170950	1/30

SG02213



Characteristic D

$I_n/I_{\Delta n}$ (A)	Type Designation	Article No.	Units per package
6/0.03	FRBm6-D6/3N/003	171003	1/30
10/0.03	FRBm6-D10/3N/003	171004	1/30
13/0.03	FRBm6-D13/3N/003	171005	1/30
16/0.03	FRBm6-D16/3N/003	171006	1/30
6/0.1	FRBm6-D6/3N/01	170933	1/30
10/0.1	FRBm6-D10/3N/01	170934	1/30
13/0.1	FRBm6-D13/3N/01	170935	1/30
16/0.1	FRBm6-D16/3N/01	170936	1/30
6/0.3	FRBm6-D6/3N/03	170961	1/30
10/0.3	FRBm6-D10/3N/03	170962	1/30
13/0.3	FRBm6-D13/3N/03	170963	1/30
16/0.3	FRBm6-D16/3N/03	170964	1/30

$I_n/I_{\Delta n}$
(A)

Type
Designation

Article No. Units per
package

Type A

4.5 kA, 3+N-poles

Conditionally surge current-proof 250 A, sensitive to residual pulsating DC, Type A 

SG02213



Characteristic C

$I_n/I_{\Delta n}$ (A)	Type Designation	Article No.	Units per package
20/0.03	FRBm4-C20/3N/003-A	171000	1/30
25/0.03	FRBm4-C25/3N/003-A	171001	1/30
32/0.03	FRBm4-C32/3N/003-A	171002	1/30
20/0.1	FRBm4-C20/3N/01-A	170930	1/30
25/0.1	FRBm4-C25/3N/01-A	170931	1/30
32/0.1	FRBm4-C32/3N/01-A	170932	1/30
20/0.3	FRBm4-C20/3N/03-A	170958	1/30
25/0.3	FRBm4-C25/3N/03-A	170959	1/30
32/0.3	FRBm4-C32/3N/03-A	170960	1/30

SG02213



Characteristic D

$I_n/I_{\Delta n}$ (A)	Type Designation	Article No.	Units per package
20/0.03	FRBm4-D20/3N/003-A	170895	1/30
20/0.1	FRBm4-D20/3N/01-A	170942	1/30
20/0.3	FRBm4-D20/3N/03-A	170970	1/30

$I_n/I_{\Delta n}$
(A)

Type
Designation

Article No. Units per
package

Type AC

4.5 kA, 3+N-poles

Conditionally surge current-proof 250 A, Type AC 

SG02213



Characteristic C

20/0.03	FRBm4-C20/3N/003	170993	1/30
25/0.03	FRBm4-C25/3N/003	170994	1/30
32/0.03	FRBm4-C32/3N/003	170995	1/30
20/0.1	FRBm4-C20/3N/01	170923	1/30
25/0.1	FRBm4-C25/3N/01	170924	1/30
32/0.1	FRBm4-C32/3N/01	170925	1/30
20/0.3	FRBm4-C20/3N/03	170951	1/30
25/0.3	FRBm4-C25/3N/03	170952	1/30
32/0.3	FRBm4-C32/3N/03	170953	1/30

SG02213



Characteristic D

20/0.03	FRBm4-D20/3N/003	171007	1/30
20/0.1	FRBm4-D20/3N/01	170937	1/30
20/0.3	FRBm4-D20/3N/03	170965	1/30

Specifications | Combined RCD/MCB Devices FRBm6, FRBm4, 3+N-poles

Description

- Combined RCD/MCB device
 - Line voltage-independent tripping
 - Compatible with standard busbar
 - Twin-purpose terminal (lift/open-mouthed) above and below
 - Busbar positioning optionally above or below
 - Free terminal space despite installed busbar
 - Guide for secure terminal connection
 - Contact position indicator red - green
 - Fault current tripping indicator white - blue
 - Comprehensive range of accessories suitable for subsequent installation
 - The test key "T" must be pressed every 6 months. The system operator must be informed of this obligation and his responsibility in a way that can be proven. Under special conditions (e.g. damply and/or dusty environments, environments with polluting and/or corroding conditions, environments with large temperature fluctuations, installations with a risk of overvoltages due to switching of equipment and/or atmospheric discharges, portable equipment ...), it's recommended to test in monthly intervals.
 - Pressing the test key "T" serves the only purpose of function testing the residual current device (RCD). This test does not make earthing resistance measurement (R_E), or proper checking of the earth conductor condition redundant, which must be performed separately.
- **Type -A:** Protects against special forms of residual pulsating DC which have not been smoothed.

Accessories:

Auxiliary switch for subsequent installation	ZP-IHK	286052
	ZP-WHK	286053
Tripping signal switch for subsequent installation	ZP-NHK	248437
Shunt trip release	ZP-ASA/..	248438, 248439
Terminal cover 4-poles	Z-TC/SD-4P	178101

Technical Data

		FRBm6, FRBm4, 3+N-poles	
Electrical			
Design according to		IEC/EN 61009, IEC/EN 60947	
Classified according to		IEC 61373, EN 45545-2	
Current test marks as printed onto the device			
Tripping line voltage-independent		instantaneous 250A (8/20µs), surge current-proof, N protected	
Rated voltage	U_n	240/415V AC, 50Hz	
Rated tripping current	$I_{\Delta n}$	30, 100, 300 mA	
Rated non-tripping current	$I_{\Delta n0}$	0.5 $I_{\Delta n}$	
Sensitivity		AC and pulsating DC	
Selectivity class		3	
Rated short circuit capacity			
FRBm6	acc. to IEC/EN61009: 6A...16A acc. to IEC/EN60947-2: 6A...16A	I_{cn}	6 kA
		I_{cu}	6 kA
		I_{cs}	3 kA
FRBm4	acc. to IEC/EN61009: 6A...32A acc. to IEC/EN60947-2: 6A...32A	I_{cn}	4.5 kA
		I_{cu}	4.5 kA
		I_{cs}	3 kA
Rated current		6 - 32 A	
Rated impulse withstand voltage	U_{imp}	4 kV (1.2/50µs)	
Characteristic		B, C, D	
Maximum back-up fuse (short circuit protection)		100 A gL (>10 kA)	
Endurance			
electrical components		≥ 4,000 operating cycles	
mechanical components		≥ 10,000 operating cycles	
Mechanical			
Frame size		45 mm	
Device height		80 mm	
Device width		70 mm (4MU)	
Mounting		3-position DIN rail clip, permits removal from existing busbar system	
Degree of protection switch		IP20	
Degree of protection, built-in		IP40	
Upper and lower terminals		open mouthed/lift terminals	
Terminal protection		finger and hand touch safe, DGUV VS3, EN 50274	
Terminal capacity		1 - 25 mm ²	
Terminal torque		2 - 2.4 Nm	
Busbar thickness		0.8 - 2 mm	
Operation temperature		-25°C to +40°C	
Storage- and transport temperature		-35°C to +70°C	
Resistance to climatic conditions		acc. to IEC 68-2 (25..55°C / 90..95% RH)	

Connection diagram

3+N-poles

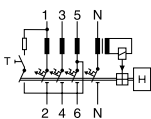

Dimensions (mm)

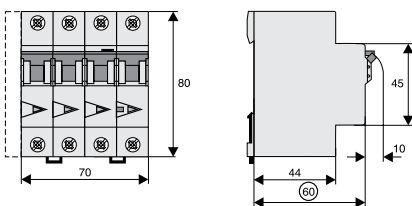

Tripping Characteristic FRBm. 3+N-poles, Characteristics B, C and D

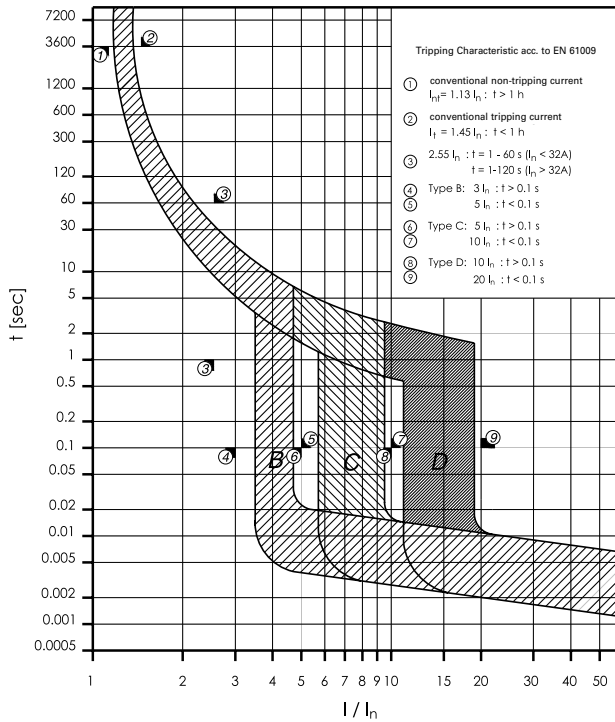

Internal Resistance FRBm. 3+N-poles

	Type B			Type C			Type D		
	L1, L2	L3	N	L1, L2	L3	N	L1, L2	L3	N
I_n [A]	R* [mΩ]	R* [mΩ]	R* [mΩ]	R* [mΩ]	R* [mΩ]	R* [mΩ]	R* [mΩ]	R* [mΩ]	R* [mΩ]
6	-	-	-	34.3	28.2	28.8	34.3	28.0	29.7
10	-	-	-	19.3	15.3	18.1	19.7	15.3	15.3
13	11.8	12.6	12.2	11.9	12.7	9.1	9.9	10.4	8.9
16	9.8	9.3	7.8	9.5	8.8	6.6	9.8	9.2	6.8
20	-	-	-	6.5	5.9	5.5	6.6	6.1	5.5
25	-	-	-	4.3	3.7	3.5	-	-	-

* 50Hz

Power Loss at I_n FRBm. 3+N-poles

(entire unit)	Type B	Type C	Type D	Ambient Temperature T [°C]											
				I_n [A]	-25	-15	-5	10	30	40	45	55	60	65	70
I_n [A]	P* [W]	P* [W]	P* [W]	6	7.7	7.4	7.1	6.6	6	5.7	5.6	5.2	5.1	4.9	4.8
6	-	4.8	4.8	10	12.6	12.1	11.6	10.9	10	9.5	9.3	8.8	8.6	8.3	8.1
10	-	8.2	7.8	13	16.8	16.1	15.4	14.4	13	12.4	12.1	11.4	11.0	10.7	10.3
13	10.2	9.4	7.7	16	19.8	19.1	18.4	17.4	16	15.3	14.9	14.2	13.9	13.5	13.2
16	11.6	10.9	11.2	20	24.8	23.9	23.1	21.7	20	19.1	18.6	17.8	17.3	16.9	16.4
20	-	11.8	12.0	25	32.9	31.4	30.1	27.8	25	23.5	22.7	21.3	20.6	19.8	19.1
25	-	11.6	-	32	40.2	38.7	37.2	35.0	32	30.5	29.7	28.2	27.5	26.7	26.0
32	-	15.6	-												

* 50Hz and ambient temperature

Back-up Protection FRBm4/FRBm6

The up-stream protective devices will protect the down-stream FRBm4/FRBm6 up to the short-circuit current specified.

FRBm and NZM1

Short circuit currents in kA.

FRBm4/ FRBm6	NZMB1(C1)(N1)(H1)-A...		
	U _e = 415 V		
	Type B	Type C	Type D
6	-	20	20
10	-	20	20
13	20	20	20
16	20	20	20
20	-	20	20
25	-	20	-

U_e = 415V: I_{cn} (FRBm4) = 4.5 kA (acc. to IEC/EN 61009)
 U_e = 415V: I_{cu} (FRBm6) = 6 kA (acc. to IEC/EN 61009)
 U_e = 400/415V: I_{cn} (NZMB1) = 25 kA (acc. to IEC/EN 60947-2)
 U_e = 400/415V: I_{cn} (NZMC1) = 36 kA (acc. to IEC/EN 60947-2)
 U_e = 400/415V: I_{cn} (NZMN1) = 50 kA (acc. to IEC/EN 60947-2)
 U_e = 400/415V: I_{cn} (NZMH1) = 100 kA (acc. to IEC/EN 60947-2)

FRBm and NZM2

Short circuit currents in kA.

FRBm4/ FRBm6	NZMB2(C2)(N2)(H2)-A...		
	U _e = 415 V		
	Type B	Type C	Type D
6	-	20	20
10	-	20	20
13	20	20	20
16	20	20	20
20	-	20	20
25	-	20	-

U_e = 415V: I_{cn} (FRBm4) = 4.5 kA (acc. to IEC/EN 61009)
 U_e = 415V: I_{cu} (FRBm6) = 6 kA (acc. to IEC/EN 61009)
 U_e = 400/415V: I_{cn} (NZMB2) = 25 kA (acc. to IEC/EN 60947-2)
 U_e = 400/415V: I_{cn} (NZMC2) = 36 kA (acc. to IEC/EN 60947-2)
 U_e = 400/415V: I_{cn} (NZMN2) = 50 kA (acc. to IEC/EN 60947-2)
 U_e = 400/415V: I_{cn} (NZMH2) = 150 kA (acc. to IEC/EN 60947-2)

FRBm4, FRBm6: Influence of ambient temperature on load carrying capacity

I _n [A]	Ambient temperature / °C											
	-25	-30	-5	10	30	40	45	50	55	60	65	70
6	7.7	7.4	7.1	6.6	6	5.7	5.6	5.4	5.2	5.1	4.9	4.8
10	12.6	12.1	11.6	10.9	10	9.5	9.3	9.1	8.8	8.6	8.3	8.1
13	16.8	16.1	15.4	14.4	13	12.4	12.0	11.7	11.4	11.0	10.7	10.3
16	19.8	19.1	18.4	17.4	16	15.3	14.9	14.6	14.2	13.9	13.5	13.2
20	24.8	23.9	23.0	21.7	20	19.1	18.6	18.2	17.8	17.3	16.9	16.4
25	32.9	31.4	30.0	27.8	25	23.5	22.7	22.0	21.3	20.6	19.8	19.1
32	40.2	38.7	37.2	35.0	32	30.5	29.7	29.0	28.2	27.5	26.7	26.0

1.154 Add-on Residual Current Protection

xEffect

Add-on Residual Current Protection Unit FBSmV, Type AC and A

SG03613



Description

- Combining this device with a top-quality miniature circuit breaker of Type FAZ (except FAZ-PN) will form a top-quality RCBO unit (combined RCD/MCB device)
- Draw-out connection bar locked in installation position
- For subsequent mounting onto 2-, 3-, 3+N- and 4-pole miniature circuit breakers FAZ
- Rated current 40 and 63 A
- 120 V Types
- Classified for the use in rail rolling stock

$I_n/I_{\Delta n}$ (A)	Type Designation	Article No.	Units per package
---------------------------	---------------------	-------------	----------------------

Type AC

Conditionally surge current-proof 250 A, Type AC 

SG03513



2-poles

40/0.03	FBSmV-40/2/003	170177	1/20
40/0.03	FBSmV-40/2/003-400	180632	1/20
63/0.03	FBSmV-63/2/003	170178	1/20
63/0.03	FBSmV-63/2/003-400	180633	1/20
40/0.1	FBSmV-40/2/01	170179	1/20
63/0.1	FBSmV-63/2/01	170180	1/20
40/0.3	FBSmV-40/2/03	170181	1/20
63/0.3	FBSmV-63/2/03	170182	1/20
40/0.5	FBSmV-40/2/05	170183	1/20
63/0.5	FBSmV-63/2/05	170184	1/20
40/1	FBSmV-40/2/1	170185	1/20
63/1	FBSmV-63/2/1	170186	1/20

SG03713



3-poles

40/0.03	FBSmV-40/3/003	170187	1/20
63/0.03	FBSmV-63/3/003	170188	1/20
40/0.1	FBSmV-40/3/01	170189	1/20
63/0.1	FBSmV-63/3/01	170190	1/20
40/0.3	FBSmV-40/3/03	170191	1/20
63/0.3	FBSmV-63/3/03	170192	1/20
40/0.5	FBSmV-40/3/05	170193	1/20
63/0.5	FBSmV-63/3/05	170194	1/20
40/1	FBSmV-40/3/1	170195	1/20
63/1	FBSmV-63/3/1	170196	1/20

SG03613



4-poles

40/0.03	FBSmV-40/4/003	170197	1/13
63/0.03	FBSmV-63/4/003	170198	1/13
40/0.1	FBSmV-40/4/01	170199	1/13
63/0.1	FBSmV-63/4/01	170200	1/13
40/0.3	FBSmV-40/4/03	170201	1/13
63/0.3	FBSmV-63/4/03	170202	1/13
40/0.5	FBSmV-40/4/05	170203	1/13
63/0.5	FBSmV-63/4/05	170204	1/13
40/1	FBSmV-40/4/1	170205	1/13
63/1	FBSmV-63/4/1	170206	1/13

1.156 Add-on Residual Current Protection

xEffect

Add-on Residual Current Protection Unit FBSmV

$I_n/I_{\Delta n}$ (A)	Type Designation	Article No.	Units per package
---------------------------	---------------------	-------------	----------------------

Type A

Conditionally surge current-proof 250 A, sensitive to residual pulsating DC, Type A 

SG03513



2-poles

40/0.03	FBSmV-40/2/003-A	170207	1/20
40/0.03	FBSmV-40/2/003-A-120	180622	1/20
40/0.03	FBSmV-40/2/003-A-400	180623	1/20
63/0.03	FBSmV-63/2/003-A	170208	1/20
63/0.03	FBSmV-63/2/003-A-120	180626	1/20
63/0.03	FBSmV-63/2/003-A-400	180627	1/20
40/0.1	FBSmV-40/2/01-A	170209	1/20
63/0.1	FBSmV-63/2/01-A	170210	1/20
40/0.3	FBSmV-40/2/03-A	170211	1/20
40/0.3	FBSmV-40/2/03-A-120	180630	1/20
63/0.3	FBSmV-63/2/03-A	170212	1/20
63/0.3	FBSmV-63/2/03-A-120	180631	1/20
40/0.5	FBSmV-40/2/05-A	170213	1/20
63/0.5	FBSmV-63/2/05-A	170214	1/20
40/1	FBSmV-40/2/1-A	170215	1/20
63/1	FBSmV-63/2/1-A	170216	1/20

SG03713



3-poles

40/0.03	FBSmV-40/3/003-A	170217	1/20
40/0.03	FBSmV-40/3/003-A-230	180624	1/20
63/0.03	FBSmV-63/3/003-A	170218	1/20
63/0.03	FBSmV-63/3/003-A-230	180628	1/20
40/0.1	FBSmV-40/3/01-A	170219	1/20
63/0.1	FBSmV-63/3/01-A	170220	1/20
40/0.3	FBSmV-40/3/03-A	170221	1/20
63/0.3	FBSmV-63/3/03-A	170222	1/20
40/0.5	FBSmV-40/3/05-A	170223	1/20
63/0.5	FBSmV-63/3/05-A	170224	1/20
40/1	FBSmV-40/3/1-A	170225	1/20
63/1	FBSmV-63/3/1-A	170226	1/20

SG03613



4-poles

40/0.03	FBSmV-40/4/003-A	170227	1/13
40/0.03	FBSmV-40/4/003-A-230	180625	1/13
63/0.03	FBSmV-63/4/003-A	170228	1/13
63/0.03	FBSmV-63/4/003-A-230	180629	1/13
40/0.1	FBSmV-40/4/01-A	170229	1/13
63/0.1	FBSmV-63/4/01-A	170230	1/13
40/0.3	FBSmV-40/4/03-A	170231	1/13
63/0.3	FBSmV-63/4/03-A	170232	1/13
40/0.5	FBSmV-40/4/05-A	170233	1/13
63/0.5	FBSmV-63/4/05-A	170234	1/13
40/1	FBSmV-40/4/1-A	170235	1/13
63/1	FBSmV-63/4/1-A	170236	1/13

$I_n/I_{\Delta n}$ (A)	Type Designation	Article No.	Units per package
---------------------------	---------------------	-------------	----------------------

Type G

Surge current-proof 3 kA, Type G (ÖVE E 8601) 

SG03513



2-poles

40/0.03	FBSmV-40/2/003-G	170237	1/20
---------	------------------	--------	------

SG03713



3-poles

40/0.03	FBSmV-40/3/003-G	170238	1/20
---------	------------------	--------	------

SG03613



4-poles

40/0.03	FBSmV-40/4/003-G	170239	1/13
---------	------------------	--------	------

Type S

Selective + surge current-proof 5 kA, Type S 

SG03513



2-poles

40/0.1	FBSmV-40/2/01-S	170240	1/20
63/0.1	FBSmV-63/2/01-S	170241	1/20
40/0.3	FBSmV-40/2/03-S	170142	1/20
63/0.3	FBSmV-63/2/03-S	170143	1/20
40/1	FBSmV-40/2/1-S	170144	1/20
63/1	FBSmV-63/2/1-S	170145	1/20

SG03713



3-poles

40/0.1	FBSmV-40/3/01-S	170146	1/20
63/0.1	FBSmV-63/3/01-S	170147	1/20
40/0.3	FBSmV-40/3/03-S	170148	1/20
63/0.3	FBSmV-63/3/03-S	170149	1/20
40/1	FBSmV-40/3/1-S	170150	1/20
63/1	FBSmV-63/3/1-S	170151	1/20

SG03613



4-poles

40/0.1	FBSmV-40/4/01-S	170152	1/13
63/0.1	FBSmV-63/4/01-S	170153	1/13
40/0.3	FBSmV-40/4/03-S	170154	1/13
63/0.3	FBSmV-63/4/03-S	170155	1/13
40/1	FBSmV-40/4/1-S	170156	1/13
63/1	FBSmV-63/4/1-S	170157	1/13

1.158 Add-on Residual Current Protection

xEffect

Add-on Residual Current Protection Unit FBSmV

$I_n/I_{\Delta n}$ (A)	Type Designation	Article No.	Units per package
---------------------------	---------------------	-------------	----------------------

Type S/A

Selective + surge current-proof typ. 5 kA, sensitive to residual pulsating DC, Type S/A 

SG03513



2-poles

40/0.1	FBSmV-40/2/01-S/A	170158	1/20
63/0.1	FBSmV-63/2/01-S/A	170159	1/20
40/0.3	FBSmV-40/2/03-S/A	170160	1/20
63/0.3	FBSmV-63/2/03-S/A	170161	1/20

SG03713



3-poles

40/0.1	FBSmV-40/3/01-S/A	170162	1/20
63/0.1	FBSmV-63/3/01-S/A	170163	1/20
40/0.3	FBSmV-40/3/03-S/A	170164	1/20
63/0.3	FBSmV-63/3/03-S/A	170165	1/20

SG03613



4-poles

40/0.1	FBSmV-40/4/01-S/A	170166	1/13
63/0.1	FBSmV-63/4/01-S/A	170167	1/13
40/0.3	FBSmV-40/4/03-S/A	170168	1/13
63/0.3	FBSmV-63/4/03-S/A	170169	1/13

Specifications | Add-on Residual Current Protection Unit FBSmV

Description

- Add-on residual current unit
- Line voltage-independent tripping
- By combining this device with a top-quality miniature circuit breaker type FAZ (except FAZ-PN) a top-quality RCBO unit (combined RCD/MCB device) is formed
- Rated current 40 and 63 A
- Permits combinations with a variety of characteristics thanks to the different rated currents and characteristics of the FAZ-miniature circuit breakers which can be connected
- Comprehensive range of accessories suitable for subsequent installation onto FAZ
- The test key "T" must be pressed every 6 months. The system operator must be informed of this obligation and his responsibility in a way that can be proven. Under special conditions (e.g. damply and/or dusty environments, environments with polluting and/or corroding conditions, environments with large temperature fluctuations, installations with a risk of overvoltages due to switching of equipment and/or atmospheric discharges, portable equipment ...), it's recommended to test in monthly intervals.
- Pressing the test key "T" serves the only purpose of function testing the residual current device (RCD). This test does not make earthing resistance measurement (R_e), or proper checking of the earth conductor condition redundant, which must be performed separately.
- **Type -A:** Protects against special forms of residual pulsating DC which have not been smoothed.
- **Type -G:** High reliability against unwanted tripping. Suitable for any circuit where personal injury or damage to property may occur in case of unwanted tripping.
- **Type -S:** Selective residual current device sensitive to AC, Type -S. Suitable for systems with surge arresters downstream of the RCD.
- **Type -S/A:** Additionally protects against special forms of residual pulsating DC which have not been smoothed.

Accessories:

Cover cap for draw-out connection bar	included
Slotted one-way cheese head screw	included

Accessories (on FAZ):

Auxiliary switch for subsequent installation	ZP-IHK	286052
	ZP-WHK	286053
Tripping signal switch for subsequent installation	ZP-NHK	248437
Remote testing module	Z-FW/001	248297
	Z-FW/003	248298
	Z-FW/010	248299
	Z-FW/030	248300
	Z-FW/050	248301
Shunt trip release	ZP-ASA/..	248438, 248439
Undervoltage release	Z-USA	258288, 248289, 248290
	Z-USD	248292, 248291
Terminal cover		
1-pole	Z-TC/MCB-1P	178102
2-poles	Z-TC/SD-2P	178099
3-poles	Z-TC/SD-3P	178100
4-poles	Z-TC/SD-4P	178101

Technical Data

		FBSmV
Electrical		
Design according to		IEC/EN 61009
Classified according to		IEC 61373, EN 45545-2
Current test marks as printed onto the device		
Tripping		instantaneous 250A (8/20µs), surge current-proof
Type G		10 ms delay 3kA (8/20µs), surge current-proof
Type S		40 ms delay 5kA (8/20µs) with selective disconnecting function, surge current-proof
Rated voltage	U_n	240/415V AC
Voltage range test circuit		
2-poles, 30mA		196-264 V~
2-poles, 30mA-120		102-132 V~
2-poles, 30mA-400		340-456 V~
2-poles, 100, 300, 500, 1000mA		196-456 V~
3-poles, 30mA		340-456 V~
3-poles, 30mA-230		196-264 V~
3-poles, 100, 300, 500, 1000mA		196-456 V~
4-poles, 30mA		340-456 V~
4-poles, 30mA-230		196-264 V~
4-poles, 100, 300, 500, 1000mA		196-456 V~
Rated frequency		50 Hz
Rated tripping current	$I_{\Delta n}$	30, 100, 300, 500, 1000 mA
Rated non-tripping current	$I_{\Delta no}$	$0.5 I_{\Delta n}$
Sensitivity		AC and pulsating DC
Rated current	I_n	$\leq 40 A, \leq 63 A$
Rated short circuit capacity	I_{cn}	same as connected FAZ, up to max. 10 kA
Mechanical		
Frame size		45 mm
Device height		90 mm
Device width		70 mm (2p), 107.5 mm (3p), 125 mm (4p)
Mounting		fix mounted onto FAZ
Degree of protection switch		IP20
Degree of protection, built-in		IP40
Fastening screw		M2.5 (slotted one-way cheese head screw)
Screw head breaking torque		> 0.6 Nm
Upper and lower terminals		lift terminals
Terminal protection		finger and hand touch safe, DGUV VS3, EN 50274
Terminal capacity		
rigid conductors		1 x (1 - 35) mm ²
flexible conductors (with wire end sleeve)		1 x (0.75 - 35) mm ²
Busbar thickness		0.8 - 2 mm
Operation temperature		-25°C to +40°C
Storage- and transport temperature		-35°C to +60°C
Resistance to climatic conditions		acc. to IEC 68-2 (25..55°C / 90..95% RH)

Connection diagram

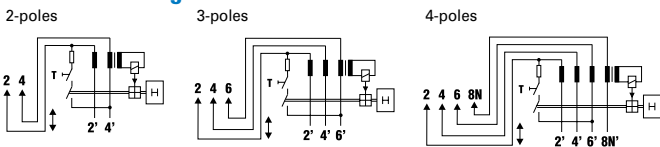

Dimensions (mm)

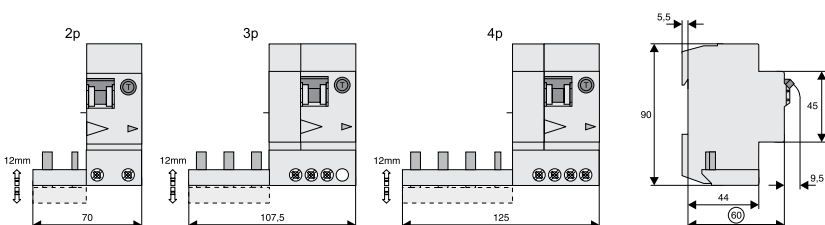

SG03913



Description

- By combining this device with a top-quality miniature circuit breaker of type AZ a top-quality RCBO unit (combined RCD/MCB device) is formed.
- Add-on residual current unit (screw connection) for 80 or 125 A (2-pole and 4-pole)
- High flexibility and ease of installation thanks to variable wiring
- Free selection of main power supply
- Auxiliary switch 1 make contact included as standard in all FBHmV versions
- Permits combinations with a variety of characteristics thanks to the different rated currents and characteristics of the miniature circuit breakers AZ which can be connected
- For commercial and industry applications
- For subsequent mounting onto 2, 3, 3+N and 4-pole-miniature circuit breakers AZ
- The screw connection to the AZ-device can be unscrewed at any time. Consequently, in case of modifications of the systems to be protected, the installation can be adapted to new requirements at any time.
- Classified for the use in rail rolling stock

1.162 Add-on Residual Current Protection

xEffect

Add-on Residual Current Protection Unit FBHmV

$I_n/I_{\Delta n}$ (A) Type Designation Article No. Units per package

Type AC

Sensitive to residual current, conditionally surge-current-proof 250 A, Type AC 

SG03813



2-poles

80/0.03	FBHmV-80/2/003	170266	1/4
125/0.03	FBHmV-125/2/003	170242	1/4
80/0.3	FBHmV-80/2/03	170243	1/4
125/0.3	FBHmV-125/2/03	170244	1/4
80/0.5	FBHmV-80/2/05	170245	1/4
125/0.5	FBHmV-125/2/05	170246	1/4
80/1	FBHmV-80/2/1	170247	1/4
125/1	FBHmV-125/2/1	170248	1/4

SG04013



4-poles

80/0.03	FBHmV-80/4/003	170249	1/4
125/0.03	FBHmV-125/4/003	170250	1/4
80/0.3	FBHmV-80/4/03	170251	1/4
125/0.3	FBHmV-125/4/03	170252	1/4
80/0.5	FBHmV-80/4/05	170253	1/4
125/0.5	FBHmV-125/4/05	170254	1/4
80/1	FBHmV-80/4/1	170255	1/4
125/1	FBHmV-125/4/1	170256	1/4

Type A

Sensitive to residual pulsating DC, conditionally surge current-proof 250 A, Type A 

SG03813



2-poles

80/0.03	FBHmV-80/2/003-A	170257	1/4
125/0.03	FBHmV-125/2/003-A	170258	1/4
80/0.3	FBHmV-80/2/03-A	170259	1/4
125/0.3	FBHmV-125/2/03-A	170260	1/4
80/0.5	FBHmV-80/2/05-A	170261	1/4
125/0.5	FBHmV-125/2/05-A	170262	1/4
80/1	FBHmV-80/2/1-A	170263	1/4
125/1	FBHmV-125/2/1-A	170264	1/4

SG03813



4-poles

80/0.03	FBHmV-80/4/003-A	170265	1/4
125/0.03	FBHmV-125/4/003-A	170130	1/4
80/0.3	FBHmV-80/4/03-A	170131	1/4
125/0.3	FBHmV-125/4/03-A	170132	1/4
80/0.5	FBHmV-80/4/05-A	170133	1/4
125/0.5	FBHmV-125/4/05-A	170134	1/4
80/1	FBHmV-80/4/1-A	170135	1/4
125/1	FBHmV-125/4/1-A	170136	1/4

Type S/A

Selective + surge current-proof 5 kA, Type S/A 

SG04113



2-poles

80/0.3	FBHmV-80/2/03-S/A	170137	1/4
125/0.3	FBHmV-125/2/03-S/A	170138	1/4
80/0.5	FBHmV-80/2/05-S/A	170139	1/4
125/0.5	FBHmV-125/2/05-S/A	170140	1/4
80/1	FBHmV-80/2/1-S/A	170141	1/4
125/1	FBHmV-125/2/1-S/A	170170	1/4

SG03913



4-poles

80/0.3	FBHmV-80/4/03-S/A	170171	1/4
125/0.3	FBHmV-125/4/03-S/A	170172	1/4
80/0.5	FBHmV-80/4/05-S/A	170173	1/4
125/0.5	FBHmV-125/4/05-S/A	170174	1/4
80/1	FBHmV-80/4/1-S/A	170175	1/4
125/1	FBHmV-125/4/1-S/A	170176	1/4

Specifications | Add-on Residual Current Protection Unit FBHmV

Description

- By combination with miniature circuit breaker AZ => RCBO-Unit (MCCB)
- Add-on residual current unit (screw connection) for 80 or 125 A (2-pole and 4-pole)
- High flexibility and ease of installation thanks to variable wiring (400 mm flexible connection wires 2p = 2 units, 4p = 4 units included in the set)
- Free selection of main power supply
- Auxiliary switch 1 NO included as standard in all FBHmV versions
- Permits combinations with a variety of characteristics thanks to the different rated currents and characteristics of the miniature circuit breakers AZ which can be connected
- For trade and industry applications
- For subsequent mounting onto 2, 3, 3+N and 4-pole-miniature circuit breakers AZ
- Toggle (serves as switch position- and tripping indicator)
- The screw connection to the AZ-device can be unscrewed at any time. Consequently, in case of modifications of the systems to be protected, the installation can be adapted to new requirements at any time.
- The test key "T" must be pressed every 6 months. The system operator must be informed of this obligation and his responsibility in a way that can be proven. Under special conditions (e.g. damply and/or dusty environments, environments with polluting and/or corroding conditions, environments with large temperature fluctuations, installations with a risk of overvoltages due to switching of equipment and/or atmospheric discharges, portable equipment ...), it's recommended to test in monthly intervals.
- Pressing the test key "T" serves the only purpose of function testing the residual current device (RCD). This test does not make earthing resistance measurement (R_E), or proper checking of the earth conductor condition redundant, which must be performed separately.

Accessories:

Flexible connection wires (connection to AZ) are included in the standard set:

	2-poles 80 A	2 x 16 mm ² (400 mm each)
	4-poles 80 A	4 x 16 mm ² (400 mm each)
	2-poles 125 A	2 x 35 mm ² (400 mm each)
	4-poles 125 A	4 x 35 mm ² (400 mm each)
Shunt trip release	Z-BHASA/24	248444
	Z-BHASA/230	248445

Technical Data

		FBHmV
Electrical current flow paths		
Design according to		IEC/EN 60947-2
Classified according to		IEC 61373, EN 45545-2
Current test marks as printed onto the device		
Tripping		instantaneous 250A (8/20µs), surge current-proof
Type S		40 ms delay 5kA (8/20µs) with selective disconnecting function, surge current-proof
Rated voltage	U_n	240/415V AC
Voltage range test circuit		
2-poles		196-264 V~
4-poles, 30mA		196-264 V~
4-poles, 100, 300, 500, 1000mA		196-456 V~
Rated frequency		50 Hz
Rated tripping current	$I_{\Delta n}$	30, 300, 500, 1000 mA
Rated non-tripping current	$I_{\Delta no}$	0.5 $I_{\Delta n}$
Sensitivity		AC and pulsating DC
Rated current	I_n	80, 125 A
Rated short circuit breaking capacity	I_{cs}	same as connected AZ
Rated short circuit capacity	I_{cn}	same as connected AZ
Rated impulse withstand voltage	U_{imp}	4 kV (1.2/50µs)
Endurance		
electrical components		
80A		≥ 1,500 operating cycles
125A		≥ 1,000 operating cycles
mechanical components		
80A		≥ 10,000 operating cycles
125A		≥ 8,000 operating cycles
Electrical Auxiliary Contact		
Category of utilization AC15		
Rated voltage	U_e	250 V AC
Rated operational current	I_e	16 A AC
Mechanical		
Frame size		45 mm
Device height		90 mm
Device width		95 mm (5,5TE)
Depth of central body		60 mm
Mounting		screwed onto AZ 2-, 3-, 4-poles; Z-BHASA
Degree of protection switch		IP20
Degree of protection, built-in		IP40
Upper and lower terminals		lift terminals
Terminal protection		finger and hand touch safe, DGUV VS3, EN 50274
Terminal capacity		
main conductor		2.5 - 50 mm ²
auxiliary switch		1 - 25 mm ²
Operation temperature		-25°C to +40°C
Storage- and transport temperature		-35°C to +60°C
Resistance to climatic conditions		acc. to IEC 68-2 (25..55°C / 90..95% RH)

Connection diagram

2-poles

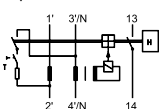

4-poles

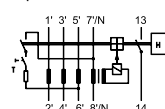

Dimensions (mm)

FBHmV/2p + AZ/2p

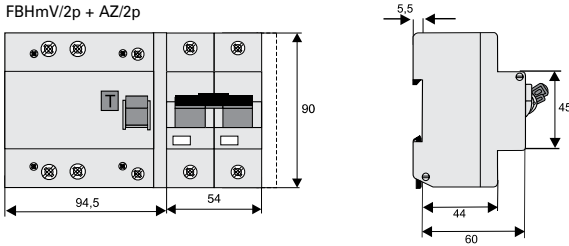

FBHmV/4p + AZ/3p+N

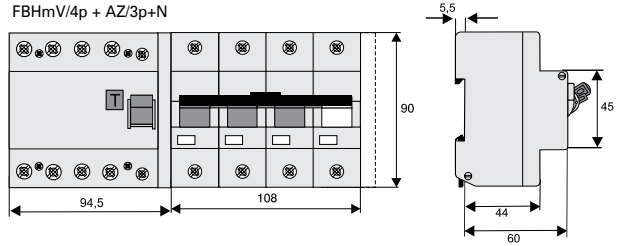

FBHmV/4p + AZ/3p

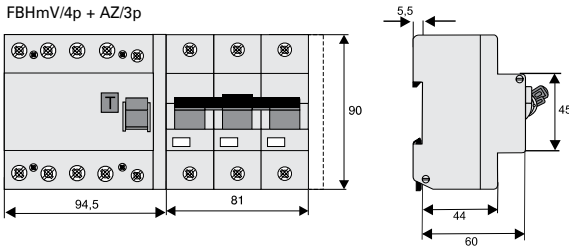

FBHmV/4p + AZ/4p

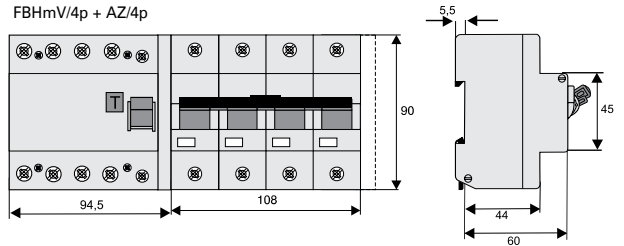

Wiring options

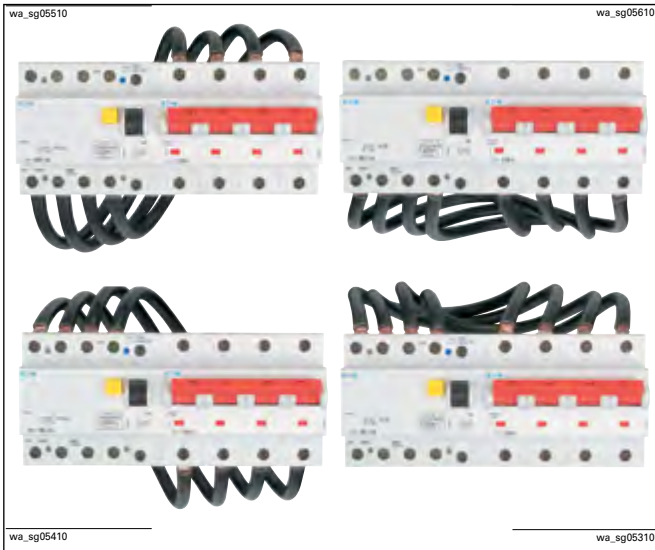

Mounting FBHmV + AZ

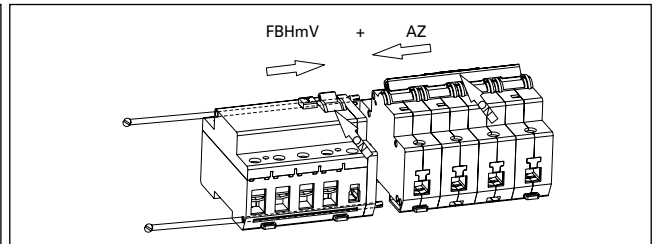

Connection FBHmV/4p + AZ/3p

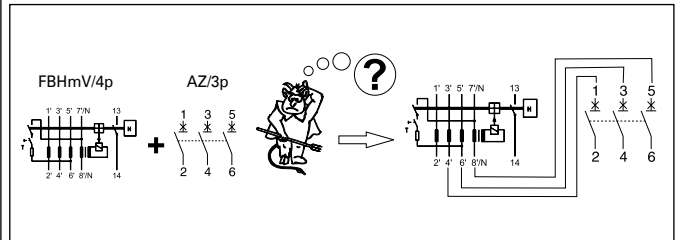

Mounting arrangement residual current protection unit - shunt trip release - miniature circuit breaker - auxiliary contact

FBHmV-2-poles

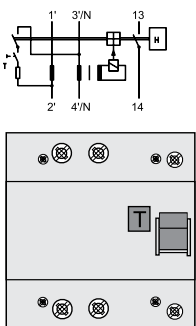

FBHmV-4-poles

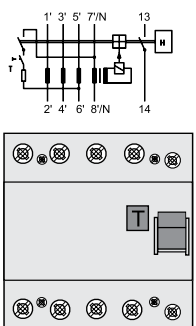

Z-BHASA

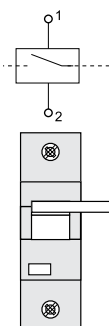

FBHmV-3+N-poles

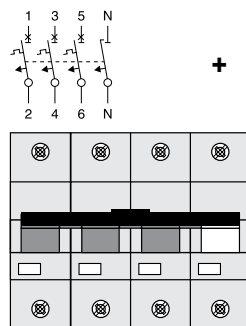

Z-LHK

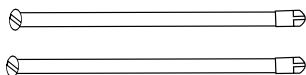
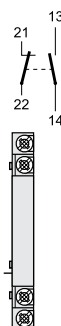

Specifications | Accessories for FBHmV - Shunt trip release Z-BHASA

Description

- Can be mounted subsequently
- Contact position indicator red - green
- Marking labels can be fitted
- Wide operational voltage range
- Sufficient power of extra low voltage source must be ensured Z-BHASA/24:
min. 90 VA
- Screws for mounting included FBHmV => BHASA => AZ

Technical Data

	Z-BHASA/24	Z-BHASA/230
Electrical		
Classified according to	IEC 61373, EN 45545-2	
Minimum pulse duration	15 ms	10 ms
Internal resistance	2 Ω	130 Ω
Duty Cycle	100%	100%
Tripping time	< 20 ms	< 20 ms
Peak withstand voltage (1.2/50µs)	2 kV	2 kV
Endurance		
electrical components	≥ 4,000 operating cycles	
mechanical components	≥ 4,000 operating cycles	
AC voltage range		
Responding limit	8 V	70 V
Operational voltage range	12-60 V	110-415 V
Maximum current consumption during switch-on	1.4-7 A	3.4 A (at 230V)
Current flow time at max. current consumption	4.0 ms	4.5 ms
DC voltage range		
Responding limit	11 V	90 V
Operational voltage range	12-60 V	110-230 V
Maximum current consumption during switch-on	1.7 A typ.	1.7 A typ.
Current flow time at max. current consumption	2 ms	4 ms
Mechanical		
Frame size	45 mm	45 mm
Device height	90 mm	90 mm
Device width	27 mm	27 mm
Mounting	quick fastening on DIN rail IEC/EN 60715	
Degree of protection switch	IP20	IP20
Degree of protection, built-in	IP40	IP40
Upper and lower terminals	lift terminals	lift terminals
Terminal protection	finger and hand touch safe, DGUV VS3, EN 50274	
Terminal capacity	2.5 - 30 mm ²	2.5 - 30 mm ²
Terminal torque	4 Nm	4 Nm

Connection diagram

2-poles

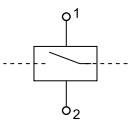

Dimensions (mm)

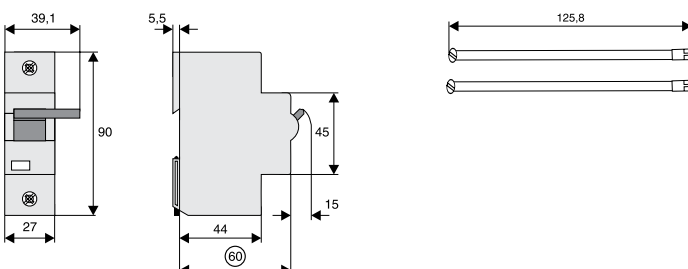

sg05317



Description

- The highest standards of safety and reliability at 24 V DC circuits
- Direct connection of up to 3 loads
- Simple and quick installation with push-in terminals and busbars
- Active current limitation
- Sequence control - easy linking of channels
- Modular system
- Individual and collective fault messages
- ON-OFF remote reset function
- Subsequent switching of system in fault situation
- PLC compatible conform to IEC/EN 61131-2
- Local sliding switch
- UL approval
- Classified for the use in rail rolling stock

PXS24 - Electronic Protective Devices for 24 V DC circuits

Rated current I_n (A)	Rated voltage U_n (V)	Type Designation	Article No.	Units per package
----------------------------	----------------------------	---------------------	-------------	----------------------

PXS24...F/ORT-IT

Standard with feed-in terminals (with Communication plug)

sg05317



2	24	PXS24S-e2/F/ORT-IT	PXS24S02A001	1/42
4	24	PXS24S-e4/F/ORT-IT	PXS24S04A001	1/42
6	24	PXS24S-e6/F/ORT-IT	PXS24S06A001	1/42
8	24	PXS24S-e8/F/ORT-IT	PXS24S08A001	1/42
10	24	PXS24S-e10/F/ORT-IT	PXS24S10A001	1/42
13	24	PXS24S-e13/F/ORT-IT	PXS24S13A001	1/42
16	24	PXS24S-e16/F/ORT-IT	PXS24S16A001	1/42

PXS24...F/ORT

Standard without feed-in terminals (with Communication plug)

sg05317



2	24	PXS24S-e2/F/ORT	PXS24S02A002	1/42
4	24	PXS24S-e4/F/ORT	PXS24S04A002	1/42
6	24	PXS24S-e6/F/ORT	PXS24S06A002	1/42
8	24	PXS24S-e8/F/ORT	PXS24S08A002	1/42
10	24	PXS24S-e10/F/ORT	PXS24S10A002	1/42
13	24	PXS24S-e13/F/ORT	PXS24S13A002	1/42
16	24	PXS24S-e16/F/ORT	PXS24S16A002	1/42

PXS24E...F-IT

Economy with feed-in terminals (without Communication plug)

sg05417



2	24	PXS24E-e2/F-IT	PXS24E02A001	1/42
4	24	PXS24E-e4/F-IT	PXS24E04A001	1/42
6	24	PXS24E-e6/F-IT	PXS24E06A001	1/42
8	24	PXS24E-e8/F-IT	PXS24E08A001	1/42
10	24	PXS24E-e10/F-IT	PXS24E10A001	1/42

PXS24E...F

Economy without feed-in terminals (without Communication plug)

sg05417



2	24	PXS24E-e2/F	PXS24E02A002	1/42
4	24	PXS24E-e4/F	PXS24E04A002	1/42
6	24	PXS24E-e6/F	PXS24E06A002	1/42
8	24	PXS24E-e8/F	PXS24E08A002	1/42
10	24	PXS24E-e10/F	PXS24E10A002	1/42

Operating voltage	Length	Type Designation	Article No.	Units per package
-------------------	--------	------------------	-------------	-------------------

Busbar

- Can be cut
- Max. current: 80 A (at 55 °C ambient temperature)

sg03718



Max. 30 V	1 m	PXS24-BB/80A/1M	PXS24BB00001	1/1
Max. 30 V	4 TE (approx. 70 mm)	PXS24-BB/80A/4TE	PXS24BB00004	1/1
Max. 30 V	8 TE (approx. 140 mm)	PXS24-BB/80A/8TE	PXS24BB00008	1/1
Max. 30 V	12 TE (approx. 210 mm)	PXS24-BB/80A/12TE	PXS24BB00012	1/1

Busbar cover

- Can be cut

sg03818



	1 m	PXS24-BBC	PXS24ACC0002	1/1
--	-----	-----------	--------------	-----

Placeholder

- Module with no electrical function

sg03918_r



		PXS24-PCH	PXS24ACC0000	1/42
--	--	-----------	--------------	------

Operating voltage	Length	Type Designation	Article No.	Units per package
-------------------	--------	------------------	-------------	-------------------

Feed-In terminals (insulated)

- 2 pieces per power supply are required!
- Terminal capacity 1.5 - 16 mm²

vt21919



		AKI16/10	184515	1/1
--	--	----------	--------	-----

Feed-In terminals (not insulated)

- 2 pieces per power supply are required!
- Terminal capacity 1.5 - 16 mm² with or without end-sleeves, rigid and flexible
- Max. load current: 60 A (at 55 °C ambient temperature, only in connection with PXS24-BB...)

sg05917



		PXS24-IT	PXS24ACC0001	1/1
--	--	----------	--------------	-----

Technical Data

Mark	CE
Certification	UL508 + UL2367 (Section 10 and 12)
Product Standard	Applicable sections of: EN60947-1, EN60947-5-1, EN61009-1, EN61131-2 and EN61000-4-2 Details see In-House Standard WN-PXS24
Classified according to	IEC 61373, EN 45545-2
Current test marks as printed onto the device	

Electrical

Operating voltage	U_B	24V DC (15...30 V DC)
Rated current	I_N	Fix; 2, 4, 6, 8, 10, 13, 16 A
Overload and short circuit current protection		Typ. $1.3 \times I_N$ with active current-limiting up to $1.25 \times I_N$
Trip characteristic		see time / current table
Capacitive Loads		up to 20,000 μ F
Inductive Loads		$I_N \leq 6 \text{ A} \dots \tau_{max} \leq 60 \text{ ms}$ $6 \text{ A} < I_N \leq 10 \text{ A} \dots \tau_{max} \leq 12 \text{ ms}$ $10 \text{ A} < I_N \leq 16 \text{ A} \dots \tau_{max} \leq 7.5 \text{ ms}$
Service life when used as a relay		see Time / Current Table

Mechanical

Number of Channels	1
Width	17.5 (1MU)
Height	92.5 mm
Depth	119.2 mm
Type of terminals	Push-In terminals
Line terminals (optional)	3x LINE (+) and 3x GND (-)
Load terminals	3x LOAD (+) and 3x GND (-)
Terminal capacity Input/Output terminals	2.5 mm ² (flexible with wire end sleeve) 4 mm ² (rigid)
Terminal capacity Communication plug	1 mm ² (flexible with wire end sleeve) 1.5 mm ² (rigid)
Communication plug	2x control output (internal linked) 2x control input (internal linked) 1x GND
Busbar	LINE (+) and GND (-); max. 80 A in various length up to 1 m
Montage	Snapping on DIN rail TH35 (EN 60715)
Status LED	Bi-colour; Green = OK; Red = tripped; OFF = channel not in use
Sliding switch	ON/OFF/Reset
Control output	Tripped; about Communication plug (according to IEC 61131-2), Class: 0.1 A; Typ1/Typ2 and Typ3 Digital Inputs Max. 30 PXS24V Other indication devices up to 0.2 A @ 24 V (EATON RMQ series,...)
Control input	ON/OFF/Reset; about Communication plug (according to IEC 61131-2) Type1/Type3; Max. 30 PXS24
Sequencer	About Communication plug
Text field	17,5 x 6 mm
Degree of protection	IP20
Operation temperature	-30 °C to +55 °C
Storage Temperature	-40 °C to +100 °C

Time / Current Table

Rated current I_N [A]	Shut-off time [ms]	Active current limiting	Service life when used as a relay $t_{on} = 0.05 \text{ s} / t_{off} = 10 \text{ s}$
2	470	$1.25 \times I_N$	> 10,000,000
4	280	$1.25 \times I_N$	> 10,000,000
6	170	$1.25 \times I_N$	> 10,000,000
8	110	$1.25 \times I_N$	400,000
10	90	$1.25 \times I_N$	10,000
13	80	$1.25 \times I_N$	no usage as relay - only protection
16	70	$1.25 \times I_N$	no usage as relay - only protection

Overview of the PXS24 features

Feature	Economy	Standard
Rated current (fixed, 2, 4, 6, 8, 10, 13, 16 A)	0-10 A	0-16 A
Active current limiting	x	x
Modular system	x	x
3 load connections (+/-)	x	x
Push-in terminals	x	x
Busbar (+/-)	x	x
Local status LED	x	x
Local switch (on/off/reset)	x	x
Sequencer		x
Digital control outputs (on/off/reset)		x
Digital control inputs (on/off/reset)		x

Note for UL applications: The PXS solid state overcurrent protector has been tested in accordance to UL 508 and CSA 22.2 No. 14 for DC general use. Temperature, overload and endurance, dielectric and breakdown of component tests were conducted. Calibration and overloaded operation tests were conducted in accordance with UL 2367.

SG55812



Description

FAZ

- High-quality miniature circuit breakers for industrial applications and residential applications
- Contact position indicator red - green
- Guide for secure terminal connection
- 3-position DIN rail clip, permits removal from existing busbar system
- Comprehensive range of accessories suitable for subsequent installation
- Rated currents up to 63 A
- Tripping characteristics B, C, D, K, S, Z
- Rated breaking capacity up to 15 kA according to IEC/EN 60947-2
- Classified for the use in rail rolling stock

FAZ-PN

- Tripping characteristic B
- Rated breaking capacity up to 6 kA according to IEC/EN 60898-1
- Module width 1MU (1+N-poles)
- Classified for the use in rail rolling stock

FAZ-HS

- Tripping characteristic B
- Rated breaking capacity up to 10 kA according to IEC/EN 60898-1
- 1- and 2-poles available
- Miniature circuit breaker with reduced Let-through-energy for control circuits to protect the auxiliary switch contacts from welding.

Rated current I_n (A)	Rated voltage acc. to IEC/EN 60947-2 (V)	Breaking capacity acc. to IEC/EN 60947-2 (kA)	Rated voltage acc. to IEC/EN 60947-2 (V)	Breaking capacity acc. to IEC/EN 60947-2 (kA)	Rated voltage acc. to UL1077 (V)	Breaking capacity acc. to UL1077 (kA)	Type Designation	Article No.	Units per package
----------------------------	--	--	--	--	---	---	---------------------	-------------	----------------------

Characteristic B

SG53112



1-pole

1	254	10	230	15	277	10	FAZ-B1/1	278520	12/120
1.5	254	10	230	15	277	10	FAZ-B1,5/1	278521	12/120
1.6	254	10	230	15	277	10	FAZ-B1,6/1	278522	12/120
2	254	10	230	15	277	10	FAZ-B2/1	278523	12/120
2.5	254	10	230	15	277	10	FAZ-B2,5/1	278524	12/120
3	254	10	230	15	277	10	FAZ-B3/1	278525	12/120
3.5	254	10	230	15	277	10	FAZ-B3,5/1	278526	12/120
4	254	10	230	15	277	10	FAZ-B4/1	278527	12/120
5	254	10	230	15	277	10	FAZ-B5/1	278528	12/120
6	254	10	230	15	277	10	FAZ-B6/1	278529	12/120
8	254	10	230	15	277	10	FAZ-B8/1	278530	12/120
10	254	10	230	15	277	10	FAZ-B10/1	278531	12/120
12	254	10	230	15	277	10	FAZ-B12/1	278532	12/120
13	254	10	230	15	277	10	FAZ-B13/1	278533	12/120
15	254	10	230	15	277	10	FAZ-B15/1	278534	12/120
16	254	10	230	15	277	10	FAZ-B16/1	278535	12/120
20	254	10	230	15	277	10	FAZ-B20/1	278536	12/120
25	254	10	230	15	277	10	FAZ-B25/1	278537	12/120
32	254	10	230	15	277	10	FAZ-B32/1	278538	12/120
40	254	10	230	15	277	5	FAZ-B40/1	278539	12/120
50	230	15	230	15	277	5	FAZ-B50/1	278540	12/120
63	230	15	230	15	277	5	FAZ-B63/1	278541	12/120

SG55612



1+N-poles

1	254	10	230	15	277	10	FAZ-B1/1N	278633	1/60
1.5	254	10	230	15	277	10	FAZ-B1,5/1N	278634	1/60
1.6	254	10	230	15	277	10	FAZ-B1,6/1N	278635	1/60
2	254	10	230	15	277	10	FAZ-B2/1N	278636	1/60
2.5	254	10	230	15	277	10	FAZ-B2,5/1N	278637	1/60
3	254	10	230	15	277	10	FAZ-B3/1N	278638	1/60
3.5	254	10	230	15	277	10	FAZ-B3,5/1N	278639	1/60
4	254	10	230	15	277	10	FAZ-B4/1N	278640	1/60
5	254	10	230	15	277	10	FAZ-B5/1N	278641	1/60
6	254	10	230	15	277	10	FAZ-B6/1N	278642	1/60
8	254	10	230	15	277	10	FAZ-B8/1N	278643	1/60
10	254	10	230	15	277	10	FAZ-B10/1N	278644	1/60
12	254	10	230	15	277	10	FAZ-B12/1N	278645	1/60
13	254	10	230	15	277	10	FAZ-B13/1N	278646	1/60
15	254	10	230	15	277	10	FAZ-B15/1N	278647	1/60
16	254	10	230	15	277	10	FAZ-B16/1N	278648	1/60
20	254	10	230	15	277	10	FAZ-B20/1N	278649	1/60
25	254	10	230	15	277	10	FAZ-B25/1N	278650	1/60
32	254	10	230	15	277	10	FAZ-B32/1N	278651	1/60
40	254	10	230	15	277	5	FAZ-B40/1N	278652	1/60
50	230	15	230	15	277	5	FAZ-B50/1N	278653	1/60
63	230	15	230	15	277	5	FAZ-B63/1N	278654	1/60

FAZ Miniature Circuit Breakers

Rated current I_n (A)	Rated voltage acc. to IEC/EN 60947-2 (V)	Breaking capacity acc. to IEC/EN 60947-2 (kA)	Rated voltage acc. to IEC/EN 60947-2 (V)	Breaking capacity acc. to IEC/EN 60947-2 (kA)	Rated voltage acc. to UL1077 (V)	Breaking capacity acc. to UL1077 (kA)	Type Designation	Article No.	Units per package
----------------------------	--	--	--	--	---	---	---------------------	-------------	----------------------

SG55112



2-poles

1	440	10	400	15	480Y/277	10	FAZ-B1/2	278719	1/60
1.5	440	10	400	15	480Y/277	10	FAZ-B1,5/2	278720	1/60
1.6	440	10	400	15	480Y/277	10	FAZ-B1,6/2	278721	1/60
2	440	10	400	15	480Y/277	10	FAZ-B2/2	278722	1/60
2.5	440	10	400	15	480Y/277	10	FAZ-B2,5/2	278723	1/60
3	440	10	400	15	480Y/277	10	FAZ-B3/2	278724	1/60
3.5	440	10	400	15	480Y/277	10	FAZ-B3,5/2	278725	1/60
4	440	10	400	15	480Y/277	10	FAZ-B4/2	278726	1/60
5	440	10	400	15	480Y/277	10	FAZ-B5/2	278727	1/60
6	440	10	400	15	480Y/277	10	FAZ-B6/2	278728	1/60
7	440	10	400	15	480Y/277	10	FAZ-B7/2	167487	1/60
8	440	10	400	15	480Y/277	10	FAZ-B8/2	278729	1/60
10	440	10	400	15	480Y/277	10	FAZ-B10/2	278730	1/60
12	440	10	400	15	480Y/277	10	FAZ-B12/2	278731	1/60
13	440	10	400	15	480Y/277	10	FAZ-B13/2	278732	1/60
15	440	10	400	15	480Y/277	10	FAZ-B15/2	278733	1/60
16	440	10	400	15	480Y/277	10	FAZ-B16/2	278734	1/60
20	440	10	400	15	480Y/277	10	FAZ-B20/2	278735	1/60
25	440	10	400	15	480Y/277	10	FAZ-B25/2	278736	1/60
32	440	10	400	15	480Y/277	10	FAZ-B32/2	278737	1/60
40	440	10	400	15	480Y/277	5	FAZ-B40/2	278738	1/60
50	400	15	400	15	480Y/277	5	FAZ-B50/2	278739	1/60
63	400	15	400	15	480Y/277	5	FAZ-B63/2	278740	1/60

SG53412



3-poles

1	440	10	400	15	480Y/277	10	FAZ-B1/3	278832	1/40
1.5	440	10	400	15	480Y/277	10	FAZ-B1,5/3	278833	1/40
1.6	440	10	400	15	480Y/277	10	FAZ-B1,6/3	278834	1/40
2	440	10	400	15	480Y/277	10	FAZ-B2/3	278835	1/40
2.5	440	10	400	15	480Y/277	10	FAZ-B2,5/3	278836	1/40
3	440	10	400	15	480Y/277	10	FAZ-B3/3	278837	1/40
3.5	440	10	400	15	480Y/277	10	FAZ-B3,5/3	278838	1/40
4	440	10	400	15	480Y/277	10	FAZ-B4/3	278839	1/40
5	440	10	400	15	480Y/277	10	FAZ-B5/3	278840	1/40
6	440	10	400	15	480Y/277	10	FAZ-B6/3	278841	1/40
7	440	10	400	15	480Y/277	10	FAZ-B7/2	167493	1/40
8	440	10	400	15	480Y/277	10	FAZ-B8/3	278842	1/40
10	440	10	400	15	480Y/277	10	FAZ-B10/3	278843	1/40
12	440	10	400	15	480Y/277	10	FAZ-B12/3	278844	1/40
13	440	10	400	15	480Y/277	10	FAZ-B13/3	278845	1/40
15	440	10	400	15	480Y/277	10	FAZ-B15/3	278846	1/40
16	440	10	400	15	480Y/277	10	FAZ-B16/3	278847	1/40
20	440	10	400	15	480Y/277	10	FAZ-B20/3	278848	1/40
25	440	10	400	15	480Y/277	10	FAZ-B25/3	278849	1/40
30	440	10	400	15	480Y/277	10	FAZ-B30/2	167494	1/40
32	440	10	400	15	480Y/277	10	FAZ-B32/3	278850	1/40
40	440	10	400	15	480Y/277	5	FAZ-B40/3	278851	1/40
50	400	15	400	15	480Y/277	5	FAZ-B50/3	278852	1/40
63	400	15	400	15	480Y/277	5	FAZ-B63/3	278853	1/40

Rated current I_n (A)	Rated voltage acc. to IEC/EN 60947-2 (V)	Breaking capacity acc. to IEC/EN 60947-2 (kA)	Rated voltage acc. to IEC/EN 60947-2 (V)	Breaking capacity acc. to IEC/EN 60947-2 (kA)	Rated voltage acc. to UL1077 (V)	Breaking capacity acc. to UL1077 (kA)	Type Designation	Article No.	Units per package
----------------------------	--	--	--	--	---	---	---------------------	-------------	----------------------

SG55712



3+N-poles

1	440	10	400	15	480Y/277	10	FAZ-B1/3N	278934	1/30
1.5	440	10	400	15	480Y/277	10	FAZ-B1,5/3N	278935	1/30
1.6	440	10	400	15	480Y/277	10	FAZ-B1,6/3N	278936	1/30
2	440	10	400	15	480Y/277	10	FAZ-B2/3N	278937	1/30
2.5	440	10	400	15	480Y/277	10	FAZ-B2,5/3N	278938	1/30
3	440	10	400	15	480Y/277	10	FAZ-B3/3N	278939	1/30
3.5	440	10	400	15	480Y/277	10	FAZ-B3,5/3N	278940	1/30
4	440	10	400	15	480Y/277	10	FAZ-B4/3N	278941	1/30
5	440	10	400	15	480Y/277	10	FAZ-B5/3N	278942	1/30
6	440	10	400	15	480Y/277	10	FAZ-B6/3N	278943	1/30
8	440	10	400	15	480Y/277	10	FAZ-B8/3N	278944	1/30
10	440	10	400	15	480Y/277	10	FAZ-B10/3N	278945	1/30
12	440	10	400	15	480Y/277	10	FAZ-B12/3N	278946	1/30
13	440	10	400	15	480Y/277	10	FAZ-B13/3N	278947	1/30
15	440	10	400	15	480Y/277	10	FAZ-B15/3N	278948	1/30
16	440	10	400	15	480Y/277	10	FAZ-B16/3N	278949	1/30
20	440	10	400	15	480Y/277	10	FAZ-B20/3N	278950	1/30
25	440	10	400	15	480Y/277	10	FAZ-B25/3N	278951	1/30
32	440	10	400	15	480Y/277	10	FAZ-B32/3N	278952	1/30
40	440	10	400	15	480Y/277	5	FAZ-B40/3N	278953	1/30
50	400	15	400	15	480Y/277	5	FAZ-B50/3N	278954	1/30
63	400	15	400	15	480Y/277	5	FAZ-B63/3N	278955	1/30

SG55812



4-poles

1	440	10	400	15	480Y/277	10	FAZ-B1/4	279020	1/30
1.5	440	10	400	15	480Y/277	10	FAZ-B1,5/4	279021	1/30
1.6	440	10	400	15	480Y/277	10	FAZ-B1,6/4	279022	1/30
2	440	10	400	15	480Y/277	10	FAZ-B2/4	279023	1/30
2.5	440	10	400	15	480Y/277	10	FAZ-B2,5/4	279024	1/30
3	440	10	400	15	480Y/277	10	FAZ-B3/4	279025	1/30
3.5	440	10	400	15	480Y/277	10	FAZ-B3,5/4	279026	1/30
4	440	10	400	15	480Y/277	10	FAZ-B4/4	279027	1/30
5	440	10	400	15	480Y/277	10	FAZ-B5/4	279028	1/30
6	440	10	400	15	480Y/277	10	FAZ-B6/4	279029	1/30
7	440	10	400	15	480Y/277	10	FAZ-B7/2	167463	1/30
8	440	10	400	15	480Y/277	10	FAZ-B8/4	279030	1/30
10	440	10	400	15	480Y/277	10	FAZ-B10/4	279031	1/30
12	440	10	400	15	480Y/277	10	FAZ-B12/4	279032	1/30
13	440	10	400	15	480Y/277	10	FAZ-B13/4	279033	1/30
15	440	10	400	15	480Y/277	10	FAZ-B15/4	279034	1/30
16	440	10	400	15	480Y/277	10	FAZ-B16/4	279035	1/30
20	440	10	400	15	480Y/277	10	FAZ-B20/4	279036	1/30
25	440	10	400	15	480Y/277	10	FAZ-B25/4	279037	1/30
30	440	10	400	15	480Y/277	10	FAZ-B30/2	167464	1/30
32	440	10	400	15	480Y/277	10	FAZ-B32/4	279038	1/30
40	440	10	400	15	480Y/277	5	FAZ-B40/4	279039	1/30
50	400	15	400	15	480Y/277	5	FAZ-B50/4	279040	1/30
63	400	15	400	15	480Y/277	5	FAZ-B63/4	279041	1/30

Rated current I_n (A)	Rated voltage acc. to IEC/EN 60947-2 (V)	Breaking capacity acc. to IEC/EN 60947-2 (kA)	Rated voltage acc. to IEC/EN 60947-2 (V)	Breaking capacity acc. to IEC/EN 60947-2 (kA)	Rated voltage acc. to UL1077 (V)	Breaking capacity acc. to UL1077 (kA)	Type Designation	Article No.	Units per package
----------------------------	--	--	--	--	---	---	---------------------	-------------	----------------------

Characteristic C

1-pole

0.16	254	10	230	15	277	5	FAZ-C0,16/1	278542	12/120
0.25	254	10	230	15	277	5	FAZ-C0,25/1	278543	12/120
0.5	254	10	230	15	277	10	FAZ-C0,5/1	278544	12/120
0.75	254	10	230	15	277	10	FAZ-C0,75/1	278545	12/120
1	254	10	230	15	277	10	FAZ-C1/1	278546	12/120
1.5	254	10	230	15	277	10	FAZ-C1,5/1	278547	12/120
1.6	254	10	230	15	277	10	FAZ-C1,6/1	278548	12/120
2	254	10	230	15	277	10	FAZ-C2/1	278549	12/120
2.5	254	10	230	15	277	10	FAZ-C2,5/1	278550	12/120
3	254	10	230	15	277	10	FAZ-C3/1	278551	12/120
3.5	254	10	230	15	277	10	FAZ-C3,5/1	278552	12/120
4	254	10	230	15	277	10	FAZ-C4/1	278553	12/120
5	254	10	230	15	277	10	FAZ-C5/1	278554	12/120
6	254	10	230	15	277	10	FAZ-C6/1	278555	12/120
8	254	10	230	15	277	10	FAZ-C8/1	278556	12/120
10	254	10	230	15	277	10	FAZ-C10/1	278557	12/120
12	254	10	230	15	277	10	FAZ-C12/1	278558	12/120
13	254	10	230	15	277	10	FAZ-C13/1	278559	12/120
15	254	10	230	15	277	10	FAZ-C15/1	278560	12/120
16	254	10	230	15	277	10	FAZ-C16/1	278561	12/120
20	254	10	230	15	277	10	FAZ-C20/1	278562	12/120
25	254	10	230	15	277	10	FAZ-C25/1	278563	12/120
32	254	10	230	15	277	10	FAZ-C32/1	278564	12/120
40	254	10	230	15	277	5	FAZ-C40/1	278565	12/120
50	230	15	230	15	277	5	FAZ-C50/1	278566	12/120
63	230	15	230	15	277	5	FAZ-C63/1	278567	12/120

SG53112



1+N-poles

0.16	254	10	230	15	277	5	FAZ-C0,16/1N	278655	1/60
0.25	254	10	230	15	277	5	FAZ-C0,25/1N	278656	1/60
0.5	254	10	230	15	277	10	FAZ-C0,5/1N	278657	1/60
0.75	254	10	230	15	277	10	FAZ-C0,75/1N	278658	1/60
1	254	10	230	15	277	10	FAZ-C1/1N	278659	1/60
1.5	254	10	230	15	277	10	FAZ-C1,5/1N	278660	1/60
1.6	254	10	230	15	277	10	FAZ-C1,6/1N	278661	1/60
2	254	10	230	15	277	10	FAZ-C2/1N	278662	1/60
2.5	254	10	230	15	277	10	FAZ-C2,5/1N	278663	1/60
3	254	10	230	15	277	10	FAZ-C3/1N	278664	1/60
3.5	254	10	230	15	277	10	FAZ-C3,5/1N	278665	1/60
4	254	10	230	15	277	10	FAZ-C4/1N	278666	1/60
5	254	10	230	15	277	10	FAZ-C5/1N	278667	1/60
6	254	10	230	15	277	10	FAZ-C6/1N	278668	1/60
8	254	10	230	15	277	10	FAZ-C8/1N	278669	1/60
10	254	10	230	15	277	10	FAZ-C10/1N	278670	1/60
12	254	10	230	15	277	10	FAZ-C12/1N	278671	1/60
13	254	10	230	15	277	10	FAZ-C13/1N	278672	1/60
15	254	10	230	15	277	10	FAZ-C15/1N	278673	1/60
16	254	10	230	15	277	10	FAZ-C16/1N	278674	1/60
20	254	10	230	15	277	10	FAZ-C20/1N	278675	1/60
25	254	10	230	15	277	10	FAZ-C25/1N	278676	1/60
32	254	10	230	15	277	10	FAZ-C32/1N	278677	1/60
40	254	10	230	15	277	5	FAZ-C40/1N	278678	1/60
50	230	15	230	15	277	5	FAZ-C50/1N	278679	1/60
63	230	15	230	15	277	5	FAZ-C63/1N	278680	1/60

SG55612



Rated current I_n (A)	Rated voltage acc. to IEC/EN 60947-2 (V)	Breaking capacity acc. to IEC/EN 60947-2 (kA)	Rated voltage acc. to IEC/EN 60947-2 (V)	Breaking capacity acc. to IEC/EN 60947-2 (kA)	Rated voltage acc. to UL1077 (V)	Breaking capacity acc. to UL1077 (kA)	Type Designation	Article No.	Units per package
----------------------------	--	--	--	--	---	---	---------------------	-------------	----------------------

SG55112



2-poles

0.16	440	10	400	15	480Y/277	5	FAZ-C0,16/2	278741	1/60
0.25	440	10	400	15	480Y/277	5	FAZ-C0,25/2	278742	1/60
0.5	440	10	400	15	480Y/277	10	FAZ-C0,5/2	278743	1/60
0.75	440	10	400	15	480Y/277	10	FAZ-C0,75/2	278744	1/60
1	440	10	400	15	480Y/277	10	FAZ-C1/2	278745	1/60
1.5	440	10	400	15	480Y/277	10	FAZ-C1,5/2	278746	1/60
1.6	440	10	400	15	480Y/277	10	FAZ-C1,6/2	278747	1/60
2	440	10	400	15	480Y/277	10	FAZ-C2/2	278748	1/60
2.5	440	10	400	15	480Y/277	10	FAZ-C2,5/2	278749	1/60
3	440	10	400	15	480Y/277	10	FAZ-C3/2	278750	1/60
3.5	440	10	400	15	480Y/277	10	FAZ-C3,5/2	278751	1/60
4	440	10	400	15	480Y/277	10	FAZ-C4/2	278752	1/60
5	440	10	400	15	480Y/277	10	FAZ-C5/2	278753	1/60
6	440	10	400	15	480Y/277	10	FAZ-C6/2	278754	1/60
8	440	10	400	15	480Y/277	10	FAZ-C8/2	278755	1/60
10	440	10	400	15	480Y/277	10	FAZ-C10/2	278756	1/60
12	440	10	400	15	480Y/277	10	FAZ-C12/2	278757	1/60
13	440	10	400	15	480Y/277	10	FAZ-C13/2	278758	1/60
15	440	10	400	15	480Y/277	10	FAZ-C15/2	278759	1/60
16	440	10	400	15	480Y/277	10	FAZ-C16/2	278760	1/60
20	440	10	400	15	480Y/277	10	FAZ-C20/2	278761	1/60
25	440	10	400	15	480Y/277	10	FAZ-C25/2	278762	1/60
32	440	10	400	15	480Y/277	10	FAZ-C32/2	278763	1/60
40	440	10	400	15	480Y/277	5	FAZ-C40/2	278764	1/60
50	400	15	400	15	480Y/277	5	FAZ-C50/2	278765	1/60
63	400	15	400	15	480Y/277	5	FAZ-C63/2	278766	1/60

SG53412



3-poles

0.16	440	10	400	15	480Y/277	5	FAZ-C0,16/3	278854	1/40
0.25	440	10	400	15	480Y/277	5	FAZ-C0,25/3	278855	1/40
0.5	440	10	400	15	480Y/277	10	FAZ-C0,5/3	278856	1/40
0.75	440	10	400	15	480Y/277	10	FAZ-C0,75/3	278857	1/40
1	440	10	400	15	480Y/277	10	FAZ-C1/3	278858	1/40
1.5	440	10	400	15	480Y/277	10	FAZ-C1,5/3	278859	1/40
1.6	440	10	400	15	480Y/277	10	FAZ-C1,6/3	278860	1/40
2	440	10	400	15	480Y/277	10	FAZ-C2/3	278861	1/40
2.5	440	10	400	15	480Y/277	10	FAZ-C2,5/3	278862	1/40
3	440	10	400	15	480Y/277	10	FAZ-C3/3	278863	1/40
3.5	440	10	400	15	480Y/277	10	FAZ-C3,5/3	278864	1/40
4	440	10	400	15	480Y/277	10	FAZ-C4/3	278865	1/40
5	440	10	400	15	480Y/277	10	FAZ-C5/3	278866	1/40
6	440	10	400	15	480Y/277	10	FAZ-C6/3	278867	1/40
7	440	10	400	15	480Y/277	10	FAZ-B7/2	167459	1/40
8	440	10	400	15	480Y/277	10	FAZ-C8/3	278868	1/40
10	440	10	400	15	480Y/277	10	FAZ-C10/3	278869	1/40
12	440	10	400	15	480Y/277	10	FAZ-C12/3	278870	1/40
13	440	10	400	15	480Y/277	10	FAZ-C13/3	278871	1/40
15	440	10	400	15	480Y/277	10	FAZ-C15/3	278872	1/40
16	440	10	400	15	480Y/277	10	FAZ-C16/3	278873	1/40
20	440	10	400	15	480Y/277	10	FAZ-C20/3	278874	1/40
25	440	10	400	15	480Y/277	10	FAZ-C25/3	278875	1/40
30	440	10	400	15	480Y/277	10	FAZ-B30/2	167460	1/40
32	440	10	400	15	480Y/277	10	FAZ-C32/3	278876	1/40
40	440	10	400	15	480Y/277	5	FAZ-C40/3	278877	1/40
50	400	15	400	15	480Y/277	5	FAZ-C50/3	278878	1/40
63	400	15	400	15	480Y/277	5	FAZ-C63/3	278879	1/40

FAZ Miniature Circuit Breakers

Rated current I_n (A)	Rated voltage acc. to IEC/EN 60947-2 (V)	Breaking capacity acc. to IEC/EN 60947-2 (kA)	Rated voltage acc. to IEC/EN 60947-2 (V)	Breaking capacity acc. to IEC/EN 60947-2 (kA)	Rated voltage acc. to UL1077 (V)	Breaking capacity acc. to UL1077 (kA)	Type Designation	Article No.	Units per package
----------------------------	--	--	--	--	---	---	---------------------	-------------	----------------------

SG55712



3+N-poles

0.16	440	10	400	15	480Y/277	5	FAZ-C0,16/3N	278956	1/30
0.25	440	10	400	15	480Y/277	5	FAZ-C0,25/3N	278957	1/30
0.5	440	10	400	15	480Y/277	10	FAZ-C0,5/3N	278958	1/30
0.75	440	10	400	15	480Y/277	10	FAZ-C0,75/3N	278959	1/30
1	440	10	400	15	480Y/277	10	FAZ-C1/3N	278960	1/30
1.5	440	10	400	15	480Y/277	10	FAZ-C1,5/3N	278961	1/30
1.6	440	10	400	15	480Y/277	10	FAZ-C1,6/3N	278962	1/30
2	440	10	400	15	480Y/277	10	FAZ-C2/3N	278963	1/30
2.5	440	10	400	15	480Y/277	10	FAZ-C2,5/3N	278964	1/30
3	440	10	400	15	480Y/277	10	FAZ-C3/3N	278965	1/30
3.5	440	10	400	15	480Y/277	10	FAZ-C3,5/3N	278966	1/30
4	440	10	400	15	480Y/277	10	FAZ-C4/3N	278967	1/30
5	440	10	400	15	480Y/277	10	FAZ-C5/3N	278968	1/30
6	440	10	400	15	480Y/277	10	FAZ-C6/3N	278969	1/30
8	440	10	400	15	480Y/277	10	FAZ-C8/3N	278970	1/30
10	440	10	400	15	480Y/277	10	FAZ-C10/3N	278971	1/30
12	440	10	400	15	480Y/277	10	FAZ-C12/3N	278972	1/30
13	440	10	400	15	480Y/277	10	FAZ-C13/3N	278973	1/30
15	440	10	400	15	480Y/277	10	FAZ-C15/3N	278974	1/30
16	440	10	400	15	480Y/277	10	FAZ-C16/3N	278975	1/30
20	440	10	400	15	480Y/277	10	FAZ-C20/3N	278976	1/30
25	440	10	400	15	480Y/277	10	FAZ-C25/3N	278977	1/30
32	440	10	400	15	480Y/277	10	FAZ-C32/3N	278978	1/30
40	440	10	400	15	480Y/277	5	FAZ-C40/3N	278979	1/30
50	400	15	400	15	480Y/277	5	FAZ-C50/3N	278980	1/30
63	400	15	400	15	480Y/277	5	FAZ-C63/3N	278981	1/30

SG55812



4-poles

0.16	440	10	400	15	480Y/277	5	FAZ-C0,16/4	279042	1/30
0.25	440	10	400	15	480Y/277	5	FAZ-C0,25/4	279043	1/30
0.5	440	10	400	15	480Y/277	10	FAZ-C0,5/4	279044	1/30
0.75	440	10	400	15	480Y/277	10	FAZ-C0,75/4	279045	1/30
1	440	10	400	15	480Y/277	10	FAZ-C1/4	279046	1/30
1.5	440	10	400	15	480Y/277	10	FAZ-C1,5/4	279047	1/30
1.6	440	10	400	15	480Y/277	10	FAZ-C1,6/4	279048	1/30
2	440	10	400	15	480Y/277	10	FAZ-C2/4	279049	1/30
2.5	440	10	400	15	480Y/277	10	FAZ-C2,5/4	279050	1/30
3	440	10	400	15	480Y/277	10	FAZ-C3/4	279051	1/30
3.5	440	10	400	15	480Y/277	10	FAZ-C3,5/4	279052	1/30
4	440	10	400	15	480Y/277	10	FAZ-C4/4	279053	1/30
5	440	10	400	15	480Y/277	10	FAZ-C5/4	279054	1/30
6	440	10	400	15	480Y/277	10	FAZ-C6/4	279055	1/30
7	440	10	400	15	480Y/277	10	FAZ-B7/2	167465	1/30
8	440	10	400	15	480Y/277	10	FAZ-C8/4	279056	1/30
10	440	10	400	15	480Y/277	10	FAZ-C10/4	279057	1/30
12	440	10	400	15	480Y/277	10	FAZ-C12/4	279058	1/30
13	440	10	400	15	480Y/277	10	FAZ-C13/4	279059	1/30
15	440	10	400	15	480Y/277	10	FAZ-C15/4	279060	1/30
16	440	10	400	15	480Y/277	10	FAZ-C16/4	279061	1/30
20	440	10	400	15	480Y/277	10	FAZ-C20/4	279062	1/30
25	440	10	400	15	480Y/277	10	FAZ-C25/4	279063	1/30
30	440	10	400	15	480Y/277	10	FAZ-B30/2	167466	1/30
32	440	10	400	15	480Y/277	10	FAZ-C32/4	279064	1/30
40	440	10	400	15	480Y/277	5	FAZ-C40/4	279065	1/30
50	400	15	400	15	480Y/277	5	FAZ-C50/4	279066	1/30
63	400	15	400	15	480Y/277	5	FAZ-C63/4	279067	1/30

Rated current I_n (A)	Rated voltage acc. to IEC/EN 60947-2 (V)	Breaking capacity acc. to IEC/EN 60947-2 (kA)	Rated voltage acc. to UL1077 (V)	Breaking capacity acc. to UL1077 (kA)	Type Designation	Article No.	Units per package
----------------------------	--	--	---	---	---------------------	-------------	----------------------

Characteristic D

SG53112



1-pole

0.5	230	15	277	5	FAZ-D0,5/1	278568	12/120
1	230	15	277	5	FAZ-D1/1	278569	12/120
1.5	230	15	277	5	FAZ-D1,5/1	278570	12/120
1.6	230	15	277	5	FAZ-D1,6/1	278571	12/120
2	230	15	277	5	FAZ-D2/1	278572	12/120
2.5	230	15	277	5	FAZ-D2,5/1	278573	12/120
3	230	15	277	5	FAZ-D3/1	278574	12/120
3.5	230	15	277	5	FAZ-D3,5/1	278575	12/120
4	230	15	277	5	FAZ-D4/1	278576	12/120
5	230	15	277	5	FAZ-D5/1	278577	12/120
6	230	15	277	5	FAZ-D6/1	278578	12/120
8	230	15	277	5	FAZ-D8/1	278579	12/120
10	230	15	277	5	FAZ-D10/1	278580	12/120
12	230	15	277	5	FAZ-D12/1	278581	12/120
13	230	15	277	5	FAZ-D13/1	278582	12/120
15	230	15	277	5	FAZ-D15/1	278583	12/120
16	230	15	277	5	FAZ-D16/1	278584	12/120
20	230	15	277	5	FAZ-D20/1	278585	12/120
25	230	15	277	5	FAZ-D25/1	278586	12/120
32	230	15	277	5	FAZ-D32/1	278587	12/120
40	230	15	277	5	FAZ-D40/1	278588	12/120
50	230	10	-	-	FAZ-D50/1	115370	12/120
63	230	10	-	-	FAZ-D63/1	115371	12/120

SG55612



1+N-poles

0.5	230	15	277	5	FAZ-D0,5/1N	278681	1/60
1	230	15	277	5	FAZ-D1/1N	278682	1/60
1.5	230	15	277	5	FAZ-D1,5/1N	278683	1/60
1.6	230	15	277	5	FAZ-D1,6/1N	278684	1/60
2	230	15	277	5	FAZ-D2/1N	278685	1/60
2.5	230	15	277	5	FAZ-D2,5/1N	278686	1/60
3	230	15	277	5	FAZ-D3/1N	278687	1/60
3.5	230	15	277	5	FAZ-D3,5/1N	278688	1/60
4	230	15	277	5	FAZ-D4/1N	278689	1/60
5	230	15	277	5	FAZ-D5/1N	278690	1/60
6	230	15	277	5	FAZ-D6/1N	278691	1/60
8	230	15	277	5	FAZ-D8/1N	278692	1/60
10	230	15	277	5	FAZ-D10/1N	278693	1/60
12	230	15	277	5	FAZ-D12/1N	278694	1/60
13	230	15	277	5	FAZ-D13/1N	278695	1/60
15	230	15	277	5	FAZ-D15/1N	278696	1/60
16	230	15	277	5	FAZ-D16/1N	278697	1/60
20	230	15	277	5	FAZ-D20/1N	278698	1/60
25	230	15	277	5	FAZ-D25/1N	278699	1/60
32	230	15	277	5	FAZ-D32/1N	278700	1/60
40	230	15	277	5	FAZ-D40/1N	278701	1/60
50	230	10	-	-	FAZ-D50/1N	115378	1/60
63	230	10	-	-	FAZ-D63/1N	115379	1/60

2.182 Miniature Circuit Breakers

FAZ Miniature Circuit Breakers

Rated current I_n (A)	Rated voltage acc. to IEC/EN 60947-2 (V)	Breaking capacity acc. to IEC/EN 60947-2 (kA)	Rated voltage acc. to UL1077 (V)	Breaking capacity acc. to UL1077 (kA)	Type Designation	Article No.	Units per package
----------------------------	--	--	---	---	---------------------	-------------	----------------------

SG55112



2-poles

0.5	400	15	480Y/277	5	FAZ-D0,5/2	278767	1/60
1	400	15	480Y/277	5	FAZ-D1/2	278768	1/60
1.5	400	15	480Y/277	5	FAZ-D1,5/2	278769	1/60
1.6	400	15	480Y/277	5	FAZ-D1,6/2	278770	1/60
2	400	15	480Y/277	5	FAZ-D2/2	278771	1/60
2.5	400	15	480Y/277	5	FAZ-D2,5/2	278772	1/60
3	400	15	480Y/277	5	FAZ-D3/2	278773	1/60
3.5	400	15	480Y/277	5	FAZ-D3,5/2	278774	1/60
4	400	15	480Y/277	5	FAZ-D4/2	278775	1/60
5	400	15	480Y/277	5	FAZ-D5/2	278776	1/60
6	400	15	480Y/277	5	FAZ-D6/2	278777	1/60
7	400	15	480Y/277	5	FAZ-D7/2	167491	1/60
8	400	15	480Y/277	5	FAZ-D8/2	278778	1/60
10	400	15	480Y/277	5	FAZ-D10/2	278779	1/60
12	400	15	480Y/277	5	FAZ-D12/2	278780	1/60
13	400	15	480Y/277	5	FAZ-D13/2	278781	1/60
15	400	15	480Y/277	5	FAZ-D15/2	278782	1/60
16	400	15	480Y/277	5	FAZ-D16/2	278783	1/60
20	400	15	480Y/277	5	FAZ-D20/2	278784	1/60
25	400	15	480Y/277	5	FAZ-D25/2	278785	1/60
30	400	15	480Y/277	5	FAZ-D30/2	167492	1/60
32	400	15	480Y/277	5	FAZ-D32/2	278786	1/60
40	400	15	480Y/277	5	FAZ-D40/2	278787	1/60
50	400	10	-	-	FAZ-D50/2	115372	1/60
63	400	10	-	-	FAZ-D63/2	115373	1/60

SG53412



3-poles

0.5	400	15	480Y/277	5	FAZ-D0,5/3	278880	1/40
1	400	15	480Y/277	5	FAZ-D1/3	278881	1/40
1.5	400	15	480Y/277	5	FAZ-D1,5/3	278882	1/40
1.6	400	15	480Y/277	5	FAZ-D1,6/3	278883	1/40
2	400	15	480Y/277	5	FAZ-D2/3	278884	1/40
2.5	400	15	480Y/277	5	FAZ-D2,5/3	278885	1/40
3	400	15	480Y/277	5	FAZ-D3/3	278886	1/40
3.5	400	15	480Y/277	5	FAZ-D3,5/3	278887	1/40
4	400	15	480Y/277	5	FAZ-D4/3	278888	1/40
5	400	15	480Y/277	5	FAZ-D5/3	278889	1/40
6	400	15	480Y/277	5	FAZ-D6/3	278890	1/40
7	400	15	480Y/277	5	FAZ-D7/3	167461	1/40
8	400	15	480Y/277	5	FAZ-D8/3	278891	1/40
10	400	15	480Y/277	5	FAZ-D10/3	278892	1/40
12	400	15	480Y/277	5	FAZ-D12/3	278893	1/40
13	400	15	480Y/277	5	FAZ-D13/3	278894	1/40
15	400	15	480Y/277	5	FAZ-D15/3	278895	1/40
16	400	15	480Y/277	5	FAZ-D16/3	278896	1/40
20	400	15	480Y/277	5	FAZ-D20/3	278897	1/40
25	400	15	480Y/277	5	FAZ-D25/3	278898	1/40
30	400	15	480Y/277	5	FAZ-D30/3	167462	1/40
32	400	15	480Y/277	5	FAZ-D32/3	278899	1/40
40	400	15	480Y/277	5	FAZ-D40/3	278900	1/40
50	400	10	-	-	FAZ-D50/3	115374	1/40
63	400	10	-	-	FAZ-D63/3	115375	1/40

Rated current I_n (A)	Rated voltage acc. to IEC/EN 60947-2 (V)	Breaking capacity acc. to IEC/EN 60947-2 (kA)	Rated voltage acc. to UL1077 (V)	Breaking capacity acc. to UL1077 (kA)	Type Designation	Article No.	Units per package
----------------------------	--	--	---	---	---------------------	-------------	----------------------

SG55712



3+N-poles

0.5	400	15	480Y/277	5	FAZ-D0,5/3N	278982	1/30
1	400	15	480Y/277	5	FAZ-D1/3N	278983	1/30
1.5	400	15	480Y/277	5	FAZ-D1,5/3N	278984	1/30
1.6	400	15	480Y/277	5	FAZ-D1,6/3N	278985	1/30
2	400	15	480Y/277	5	FAZ-D2/3N	278986	1/30
2.5	400	15	480Y/277	5	FAZ-D2,5/3N	278987	1/30
3	400	15	480Y/277	5	FAZ-D3/3N	278988	1/30
3.5	400	15	480Y/277	5	FAZ-D3,5/3N	278989	1/30
4	400	15	480Y/277	5	FAZ-D4/3N	278990	1/30
5	400	15	480Y/277	5	FAZ-D5/3N	278991	1/30
6	400	15	480Y/277	5	FAZ-D6/3N	278992	1/30
8	400	15	480Y/277	5	FAZ-D8/3N	278993	1/30
10	400	15	480Y/277	5	FAZ-D10/3N	278994	1/30
12	400	15	480Y/277	5	FAZ-D12/3N	278995	1/30
13	400	15	480Y/277	5	FAZ-D13/3N	278996	1/30
15	400	15	480Y/277	5	FAZ-D15/3N	278997	1/30
16	400	15	480Y/277	5	FAZ-D16/3N	278998	1/30
20	400	15	480Y/277	5	FAZ-D20/3N	278999	1/30
25	400	15	480Y/277	5	FAZ-D25/3N	279000	1/30
32	400	15	480Y/277	5	FAZ-D32/3N	279001	1/30
40	400	15	480Y/277	5	FAZ-D40/3N	279002	1/30
50	400	10	-	-	FAZ-D50/3N	115380	1/30
63	400	10	-	-	FAZ-D63/3N	115381	1/30

SG55812



4-poles

0.5	400	15	480Y/277	5	FAZ-D0,5/4	279068	1/30
1	400	15	480Y/277	5	FAZ-D1/4	279069	1/30
1.5	400	15	480Y/277	5	FAZ-D1,5/4	279070	1/30
1.6	400	15	480Y/277	5	FAZ-D1,6/4	279071	1/30
2	400	15	480Y/277	5	FAZ-D2/4	279072	1/30
2.5	400	15	480Y/277	5	FAZ-D2,5/4	279073	1/30
3	400	15	480Y/277	5	FAZ-D3/4	279074	1/30
3.5	400	15	480Y/277	5	FAZ-D3,5/4	279075	1/30
4	400	15	480Y/277	5	FAZ-D4/4	279076	1/30
5	400	15	480Y/277	5	FAZ-D5/4	279077	1/30
6	400	15	480Y/277	5	FAZ-D6/4	279078	1/30
7	400	15	480Y/277	5	FAZ-D7/4	167467	1/30
8	400	15	480Y/277	5	FAZ-D8/4	279079	1/30
10	400	15	480Y/277	5	FAZ-D10/4	279080	1/30
12	400	15	480Y/277	5	FAZ-D12/4	279081	1/30
13	400	15	480Y/277	5	FAZ-D13/4	279082	1/30
15	400	15	480Y/277	5	FAZ-D15/4	279083	1/30
16	400	15	480Y/277	5	FAZ-D16/4	279084	1/30
20	400	15	480Y/277	5	FAZ-D20/4	279085	1/30
25	400	15	480Y/277	5	FAZ-D25/4	279086	1/30
30	400	15	480Y/277	5	FAZ-D30/4	167468	1/30
32	400	15	480Y/277	5	FAZ-D32/4	279087	1/30
40	400	15	480Y/277	5	FAZ-D40/4	279088	1/30
50	400	10	-	-	FAZ-D50/4	115376	1/30
63	400	10	-	-	FAZ-D63/4	115377	1/30

FAZ Miniature Circuit Breakers

Rated current I_n (A)	Rated voltage acc. to IEC/EN 60947-2 (V)	Breaking capacity acc. to IEC/EN 60947-2 (kA)	Rated voltage acc. to UL1077 (V)	Breaking capacity acc. to UL1077 (kA)	Type Designation	Article No.	Units per package
----------------------------	--	--	---	---	---------------------	-------------	----------------------

Characteristic K

1-pole

0.5	240	10	277	5	FAZ-K0,5/1	278589	12/120
1	240	10	277	5	FAZ-K1/1	278590	12/120
1.6	240	10	277	5	FAZ-K1,6/1	278591	12/120
2	240	10	277	5	FAZ-K2/1	278592	12/120
3	240	10	277	5	FAZ-K3/1	278593	12/120
4	240	10	277	5	FAZ-K4/1	278594	12/120
6	240	10	277	5	FAZ-K6/1	278595	12/120
8	240	10	277	5	FAZ-K8/1	278596	12/120
10	240	10	277	5	FAZ-K10/1	278597	12/120
13	240	10	277	5	FAZ-K13/1	278598	12/120
16	240	10	277	5	FAZ-K16/1	278599	12/120
20	240	10	277	5	FAZ-K20/1	278600	12/120
25	240	10	277	5	FAZ-K25/1	278601	12/120
32	240	10	277	5	FAZ-K32/1	278602	12/120
40	240	10	277	5	FAZ-K40/1	278603	12/120
50	240	10	277	5	FAZ-K50/1	278604	12/120
63	240	10	277	5	FAZ-K63/1	278605	12/120

SG53112



1+N-poles

0.5	240	10	277	5	FAZ-K0,5/1N	278702	1/60
1	240	10	277	5	FAZ-K1/1N	278703	1/60
1.6	240	10	277	5	FAZ-K1,6/1N	278704	1/60
2	240	10	277	5	FAZ-K2/1N	278705	1/60
3	240	10	277	5	FAZ-K3/1N	278706	1/60
4	240	10	277	5	FAZ-K4/1N	278707	1/60
6	240	10	277	5	FAZ-K6/1N	278708	1/60
8	240	10	277	5	FAZ-K8/1N	278709	1/60
10	240	10	277	5	FAZ-K10/1N	278710	1/60
13	240	10	277	5	FAZ-K13/1N	278711	1/60
16	240	10	277	5	FAZ-K16/1N	278712	1/60
20	240	10	277	5	FAZ-K20/1N	278713	1/60
25	240	10	277	5	FAZ-K25/1N	278714	1/60
32	240	10	277	5	FAZ-K32/1N	278715	1/60
40	240	10	277	5	FAZ-K40/1N	278716	1/60
50	240	10	277	5	FAZ-K50/1N	278717	1/60
63	240	10	277	5	FAZ-K63/1N	278718	1/60

SG55612



Rated current I_n (A)	Rated voltage acc. to IEC/EN 60947-2 (V)	Breaking capacity acc. to IEC/EN 60947-2 (kA)	Rated voltage acc. to UL1077 (V)	Breaking capacity acc. to UL1077 (kA)	Type Designation	Article No.	Units per package
----------------------------	--	--	---	---	---------------------	-------------	----------------------

SG55112



2-poles

0.5	415	10	480Y/277	5	FAZ-K0,5/2	278788	1/60
1	415	10	480Y/277	5	FAZ-K1/2	278789	1/60
1.6	415	10	480Y/277	5	FAZ-K1,6/2	278790	1/60
2	415	10	480Y/277	5	FAZ-K2/2	278791	1/60
3	415	10	480Y/277	5	FAZ-K3/2	278792	1/60
4	415	10	480Y/277	5	FAZ-K4/2	278793	1/60
6	415	10	480Y/277	5	FAZ-K6/2	278794	1/60
8	415	10	480Y/277	5	FAZ-K8/2	278795	1/60
10	415	10	480Y/277	5	FAZ-K10/2	278796	1/60
13	415	10	480Y/277	5	FAZ-K13/2	278797	1/60
16	415	10	480Y/277	5	FAZ-K16/2	278798	1/60
20	415	10	480Y/277	5	FAZ-K20/2	278799	1/60
25	415	10	480Y/277	5	FAZ-K25/2	278800	1/60
32	415	10	480Y/277	5	FAZ-K32/2	278801	1/60
40	415	10	480Y/277	5	FAZ-K40/2	278802	1/60
50	415	10	480Y/277	5	FAZ-K50/2	278803	1/60
63	415	10	480Y/277	5	FAZ-K63/2	278804	1/60

SG53412



3-poles

0.5	415	10	480Y/277	5	FAZ-K0,5/3	278901	1/40
1	415	10	480Y/277	5	FAZ-K1/3	278902	1/40
1.6	415	10	480Y/277	5	FAZ-K1,6/3	278903	1/40
2	415	10	480Y/277	5	FAZ-K2/3	278904	1/40
3	415	10	480Y/277	5	FAZ-K3/3	278905	1/40
4	415	10	480Y/277	5	FAZ-K4/3	278906	1/40
6	415	10	480Y/277	5	FAZ-K6/3	278907	1/40
8	415	10	480Y/277	5	FAZ-K8/3	278908	1/40
10	415	10	480Y/277	5	FAZ-K10/3	278909	1/40
13	415	10	480Y/277	5	FAZ-K13/3	278910	1/40
16	415	10	480Y/277	5	FAZ-K16/3	278911	1/40
20	415	10	480Y/277	5	FAZ-K20/3	278912	1/40
25	415	10	480Y/277	5	FAZ-K25/3	278913	1/40
32	415	10	480Y/277	5	FAZ-K32/3	278914	1/40
40	415	10	480Y/277	5	FAZ-K40/3	278915	1/40
50	415	10	480Y/277	5	FAZ-K50/3	278916	1/40
63	415	10	480Y/277	5	FAZ-K63/3	278917	1/40

SG55712



3+N-poles

0.5	415	10	480Y/277	5	FAZ-K0,5/3N	279003	1/30
1	415	10	480Y/277	5	FAZ-K1/3N	279004	1/30
1.6	415	10	480Y/277	5	FAZ-K1,6/3N	279005	1/30
2	415	10	480Y/277	5	FAZ-K2/3N	279006	1/30
3	415	10	480Y/277	5	FAZ-K3/3N	279007	1/30
4	415	10	480Y/277	5	FAZ-K4/3N	279008	1/30
6	415	10	480Y/277	5	FAZ-K6/3N	279009	1/30
8	415	10	480Y/277	5	FAZ-K8/3N	279010	1/30
10	415	10	480Y/277	5	FAZ-K10/3N	279011	1/30
13	415	10	480Y/277	5	FAZ-K13/3N	279012	1/30
16	415	10	480Y/277	5	FAZ-K16/3N	279013	1/30
20	415	10	480Y/277	5	FAZ-K20/3N	279014	1/30
25	415	10	480Y/277	5	FAZ-K25/3N	279015	1/30
32	415	10	480Y/277	5	FAZ-K32/3N	279016	1/30
40	415	10	480Y/277	5	FAZ-K40/3N	279017	1/30
50	415	10	480Y/277	5	FAZ-K50/3N	279018	1/30
63	415	10	480Y/277	5	FAZ-K63/3N	279019	1/30

FAZ Miniature Circuit Breakers

Rated current I_n (A)	Rated voltage acc. to IEC/EN 60947-2 (V)	Breaking capacity acc. to IEC/EN 60947-2 (kA)	Rated voltage acc. to UL1077 (V)	Breaking capacity acc. to UL1077 (kA)	Type Designation	Article No.	Units per package
----------------------------	--	--	---	---	---------------------	-------------	----------------------

SG55812



4-poles

0.5	415	10	480Y/277	5	FAZ-K0,5/4	279089	1/30
1	415	10	480Y/277	5	FAZ-K1/4	279090	1/30
1.6	415	10	480Y/277	5	FAZ-K1,6/4	279091	1/30
2	415	10	480Y/277	5	FAZ-K2/4	279092	1/30
3	415	10	480Y/277	5	FAZ-K3/4	279093	1/30
4	415	10	480Y/277	5	FAZ-K4/4	279094	1/30
6	415	10	480Y/277	5	FAZ-K6/4	279095	1/30
8	415	10	480Y/277	5	FAZ-K8/4	279096	1/30
10	415	10	480Y/277	5	FAZ-K10/4	279097	1/30
13	415	10	480Y/277	5	FAZ-K13/4	279098	1/30
16	415	10	480Y/277	5	FAZ-K16/4	279099	1/30
20	415	10	480Y/277	5	FAZ-K20/4	279100	1/30
25	415	10	480Y/277	5	FAZ-K25/4	279101	1/30
32	415	10	480Y/277	5	FAZ-K32/4	279102	1/30
40	415	10	480Y/277	5	FAZ-K40/4	279103	1/30
50	415	10	480Y/277	5	FAZ-K50/4	279104	1/30
63	415	10	480Y/277	5	FAZ-K63/4	279105	1/30

Rated current I_n (A)	Rated voltage acc. to IEC/EN 60947-2 (V)	Breaking capacity acc. to IEC/EN 60947-2 (kA)	Rated voltage acc. to UL1077 (V)	Breaking capacity acc. to UL1077 (kA)	Type Designation	Article No.	Units per package
----------------------------	--	--	---	---	---------------------	-------------	----------------------

Characteristic S

1-pole

1	240	10	277	5	FAZ-S1/1	278606	12/120
2	240	10	277	5	FAZ-S2/1	278607	12/120
3	240	10	277	5	FAZ-S3/1	278608	12/120
4	240	10	277	5	FAZ-S4/1	278609	12/120
6	240	10	277	5	FAZ-S6/1	278610	12/120
10	240	10	277	5	FAZ-S10/1	278611	12/120
16	240	10	277	5	FAZ-S16/1	278612	12/120
20	240	10	277	5	FAZ-S20/1	278613	12/120
25	240	10	277	5	FAZ-S25/1	278614	12/120
32	240	10	277	5	FAZ-S32/1	278615	12/120
40	240	10	277	5	FAZ-S40/1	278616	12/120

SG53112



2-poles

1	415	10	480Y/277	5	FAZ-S1/2	278805	1/60
2	415	10	480Y/277	5	FAZ-S2/2	278806	1/60
3	415	10	480Y/277	5	FAZ-S3/2	278807	1/60
4	415	10	480Y/277	5	FAZ-S4/2	278808	1/60
6	415	10	480Y/277	5	FAZ-S6/2	278809	1/60
10	415	10	480Y/277	5	FAZ-S10/2	278810	1/60
16	415	10	480Y/277	5	FAZ-S16/2	278811	1/60
20	415	10	480Y/277	5	FAZ-S20/2	278812	1/60
25	415	10	480Y/277	5	FAZ-S25/2	278813	1/60
32	415	10	480Y/277	5	FAZ-S32/2	278814	1/60
40	415	10	480Y/277	5	FAZ-S40/2	278815	1/60

SG55112



2.188 Miniature Circuit Breakers

FAZ Miniature Circuit Breakers

Rated current I_n (A)	Rated voltage acc. to IEC/EN 60947-2 (V)	Breaking capacity acc. to IEC/EN 60947-2 (kA)	Rated voltage acc. to UL1077 (V)	Breaking capacity acc. to UL1077 (kA)	Type Designation	Article No.	Units per package
----------------------------	--	--	---	---	---------------------	-------------	----------------------

Characteristic Z

1-pole

0.5	240	10	277	5	FAZ-Z0,5/1	278617	12/120
1	240	10	277	5	FAZ-Z1/1	278618	12/120
1.6	240	10	277	5	FAZ-Z1,6/1	278619	12/120
2	240	10	277	5	FAZ-Z2/1	278620	12/120
3	240	10	277	5	FAZ-Z3/1	278621	12/120
4	240	10	277	5	FAZ-Z4/1	278622	12/120
6	240	10	277	5	FAZ-Z6/1	278623	12/120
8	240	10	277	5	FAZ-Z8/1	278624	12/120
10	240	10	277	5	FAZ-Z10/1	278625	12/120
13	240	10	277	5	FAZ-Z13/1	106020	12/120
16	240	10	277	5	FAZ-Z16/1	278626	12/120
20	240	10	277	5	FAZ-Z20/1	278627	12/120
25	240	10	277	5	FAZ-Z25/1	278628	12/120
32	240	10	277	5	FAZ-Z32/1	278629	12/120
40	240	10	277	5	FAZ-Z40/1	278630	12/120
50	240	10	277	5	FAZ-Z50/1	278631	12/120
63	240	10	277	5	FAZ-Z63/1	278632	12/120

SG53112



2-poles

0.5	415	10	480Y/277	5	FAZ-Z0,5/2	278816	1/60
1	415	10	480Y/277	5	FAZ-Z1/2	278817	1/60
1.6	415	10	480Y/277	5	FAZ-Z1,6/2	278818	1/60
2	415	10	480Y/277	5	FAZ-Z2/2	278819	1/60
3	415	10	480Y/277	5	FAZ-Z3/2	278820	1/60
4	415	10	480Y/277	5	FAZ-Z4/2	278821	1/60
6	415	10	480Y/277	5	FAZ-Z6/2	278822	1/60
8	415	10	480Y/277	5	FAZ-Z8/2	278823	1/60
10	415	10	480Y/277	5	FAZ-Z10/2	278824	1/60
13	415	10	480Y/277	5	FAZ-Z13/2	106021	1/60
16	415	10	480Y/277	5	FAZ-Z16/2	278825	1/60
20	415	10	480Y/277	5	FAZ-Z20/2	278826	1/60
25	415	10	480Y/277	5	FAZ-Z25/2	278827	1/60
32	415	10	480Y/277	5	FAZ-Z32/2	278828	1/60
40	415	10	480Y/277	5	FAZ-Z40/2	278829	1/60
50	415	10	480Y/277	5	FAZ-Z50/2	278830	1/60
63	415	10	480Y/277	5	FAZ-Z63/2	278831	1/60

SG55112



Rated current I_n (A)	Rated voltage acc. to IEC/EN 60947-2 (V)	Breaking capacity acc. to IEC/EN 60947-2 (kA)	Rated voltage acc. to UL1077 (V)	Breaking capacity acc. to UL1077 (kA)	Type Designation	Article No.	Units per package
----------------------------	--	--	---	---	---------------------	-------------	----------------------

SG53412



3-poles

0.5	415	10	480Y/277	5	FAZ-Z0,5/3	278918	1/40
1	415	10	480Y/277	5	FAZ-Z1/3	278919	1/40
1.6	415	10	480Y/277	5	FAZ-Z1,6/3	278920	1/40
2	415	10	480Y/277	5	FAZ-Z2/3	278921	1/40
3	415	10	480Y/277	5	FAZ-Z3/3	278922	1/40
4	415	10	480Y/277	5	FAZ-Z4/3	278923	1/40
6	415	10	480Y/277	5	FAZ-Z6/3	278924	1/40
8	415	10	480Y/277	5	FAZ-Z8/3	278925	1/40
10	415	10	480Y/277	5	FAZ-Z10/3	278926	1/40
13	415	10	480Y/277	5	FAZ-Z13/3	106022	1/40
16	415	10	480Y/277	5	FAZ-Z16/3	278927	1/40
20	415	10	480Y/277	5	FAZ-Z20/3	278928	1/40
25	415	10	480Y/277	5	FAZ-Z25/3	278929	1/40
32	415	10	480Y/277	5	FAZ-Z32/3	278930	1/40
40	415	10	480Y/277	5	FAZ-Z40/3	278931	1/40
50	415	10	480Y/277	5	FAZ-Z50/3	278932	1/40
63	415	10	480Y/277	5	FAZ-Z63/3	278933	1/40

SG55812



4-poles

0.5	415	10	480Y/277	5	FAZ-Z0,5/4	279106	1/60
1	415	10	480Y/277	5	FAZ-Z1/4	279107	1/60
1.6	415	10	480Y/277	5	FAZ-Z1,6/4	279108	1/60
2	415	10	480Y/277	5	FAZ-Z2/4	279109	1/60
3	415	10	480Y/277	5	FAZ-Z3/4	279110	1/60
4	415	10	480Y/277	5	FAZ-Z4/4	279111	1/60
6	415	10	480Y/277	5	FAZ-Z6/4	279112	1/60
8	415	10	480Y/277	5	FAZ-Z8/4	279113	1/60
10	415	10	480Y/277	5	FAZ-Z10/4	279114	1/60
13	415	10	480Y/277	5	FAZ-Z13/4	106023	1/60
16	415	10	480Y/277	5	FAZ-Z16/4	279115	1/60
20	415	10	480Y/277	5	FAZ-Z20/4	279116	1/60
25	415	10	480Y/277	5	FAZ-Z25/4	279117	1/60
32	415	10	480Y/277	5	FAZ-Z32/4	279118	1/60
40	415	10	480Y/277	5	FAZ-Z40/4	279119	1/60
50	415	10	480Y/277	5	FAZ-Z50/4	279120	1/60
63	415	10	480Y/277	5	FAZ-Z63/4	279121	1/60

2.190 Miniature Circuit Breakers

FAZ-PN Miniature Circuit Breakers

Rated current I_n (A)	Rated voltage (V)	Breaking capacity acc. to IEC/EN 60898-1 (kA)	Breaking capacity acc. to IEC/EN 60947-2 (kA)	Type Designation	Article No.	Units per package
----------------------------	----------------------	---	---	---------------------	-------------	----------------------

Characteristic B

1+N-poles (1MU)

6	240	6	10	FAZ-PN-B6/1N	279146	12/120
10	240	6	10	FAZ-PN-B10/1N	279147	12/120
13	240	6	10	FAZ-PN-B13/1N	279148	12/120
16	240	6	10	FAZ-PN-B16/1N	279149	12/120
20	240	6	10	FAZ-PN-B20/1N	279150	12/120
25	240	6	10	FAZ-PN-B25/1N	279151	12/120
32	240	6	10	FAZ-PN-B32/1N	279152	12/120
40	240	6	10	FAZ-PN-B40/1N	279153	12/120

SG54212



Characteristic C

1+N-poles (1MU)

2	240	6	10	FAZ-PN-C2/1N	279154	12/120
4	240	6	10	FAZ-PN-C4/1N	279155	12/120
6	240	6	10	FAZ-PN-C6/1N	279156	12/120
10	240	6	10	FAZ-PN-C10/1N	279157	12/120
13	240	6	10	FAZ-PN-C13/1N	279158	12/120
16	240	6	10	FAZ-PN-C16/1N	279159	12/120
20	240	6	10	FAZ-PN-C20/1N	279160	12/120
25	240	6	10	FAZ-PN-C25/1N	279161	12/120
32	240	6	10	FAZ-PN-C32/1N	279162	12/120
40	240	6	10	FAZ-PN-C40/1N	279163	12/120

SG54212



Rated current I_n (A)	Rated voltage (V)	Breaking capacity acc. to IEC/EN 60898-1 (kA)	Type Designation	Article No.	Units per package
----------------------------	----------------------	---	---------------------	-------------	----------------------

Characteristic B

- Miniature bircuit breaker with reduced Let-through-energy for control circuits to protect the auxilliary switch contacts from welding.

wa_sg00114



1-pole

4	240	10	FAZ-B4/1-HS	279274	12/120
---	-----	----	-------------	--------	--------

SG55512



2-poles

4	240	10	FAZ-B4/2-HS	279275	1/60
---	-----	----	-------------	--------	------

Miniature Circuit Breakers FAZ

Accessories:

Auxiliary switch for subsequent installation	FAZ-XHIN11	286054
	FAZ-XHINW1	286055
Tripping signal contact for subsequent installation	FAZ-XAM002	262414
Shunt trip release	ZP-ASA/..	248438, 248439
Undervoltage release	FAZ-XAA..	278518, 278519
	FAZ-XUA...	212049, 212051, 212053
Switching interlock	Z-IS/SPE-1TE	274418
Terminal cover		
1-pole	Z-TC/MCB-1P	178102
2-poles	Z-TC/SD-2P	178099
3-poles	Z-TC/SD-3P	178100
4-poles	Z-TC/SD-4P	178101

Technical Data

Electrical	B Characteristic		C Characteristic		D Characteristic
Approvals	CE, VDE				
Classified according to	IEC 61373, EN 45545-2				
Current test marks as printed onto the device					
Standards	IEC/EN 60947-2				
Short-circuit trip response	3–5 I _n		5–10 I _n		10–20 I _n
Supplementary Protectors - UL/CSA					
Current range	1–63 A		0.16–63 A		0.5–40 A
Maximum voltage ratings - UL/CSA					
Single-pole, single-pole + neutral	277 V AC 48 V DC		277 V AC 48 V DC		277 V AC 48 V DC
Two-, three-, four-pole and three-pole + neutral	480Y/277 V AC		480Y/277 V AC		480Y/277 V AC
Two poles in series	96 V DC		96 V DC		96 V DC
Thermal tripping characteristics					
Single-pole	< 1 hour @ 1.35 x I _n @ 40°C		< 1 hour @ 1.35 x I _n @ 40°C		< 1 hour @ 1.35 x I _n @ 40°C
Multi-pole	< 1 hour @ 1.45 x I _n @ 40°C		< 1 hour @ 1.45 x I _n @ 40°C		< 1 hour @ 1.45 x I _n @ 40°C
Short-circuit ratings (at max. voltage)					
Single-pole	10 kA (5 kA for 40–63A device)		10 kA (5 kA for 40–63A device)		5 kA
Two-, three-pole	10 kA (5 kA for 40–63A device)		10 kA (5 kA for 40–63A device)		5 kA
Single-pole	10 kA @ 48 V DC		10 kA @ 48 V DC		10 kA @ 48 V DC
Two poles in series	10 kA @ 96 V DC		10 kA @ 96 V DC		10 kA @ 96 V DC
Miniature Circuit Breaker - IEC					
Current range	1–40 A	50–63 A	0.16–40 A	50–63 A	0.5–63 A
Maximum voltage ratings - IEC 60947-2					
Single-pole, single-pole + neutral	254 V AC 60 V DC	230 V AC 60 V DC	254 V AC 60 V DC	230 V AC 60 V DC	230 V AC 60 V DC
Two-, three-, four-pole and three-pole + neutral	440 V AC	400 V AC	440 V AC	400 V AC	400 V AC
Maximum voltage ratings - IEC 60898					
Single-pole, single-pole + neutral	240 V AC	240 V AC	240 V AC	240 V AC	240 V AC
Two-, three-, four-pole and three-pole + neutral	415 V AC	415 V AC	415 V AC	415 V AC	415 V AC
Thermal tripping characteristics - IEC 60947-2					
	> 1 hour @ 1.05 x I _n @ 40°C		> 1 hour @ 1.05 x I _n @ 40°C		> 1 hour @ 1.05 x I _n @ 40°C
	< 1 hour @ 1.3 x I _n @ 40°C		< 1 hour @ 1.3 x I _n @ 40°C		< 1 hour @ 1.3 x I _n @ 40°C
Interrupt ratings (at max. voltage)					
IEC 60947-2	10 kA	15 kA	10 kA	15 kA	15 kA (type D50 and D63: 10k A)
IEC 60898	10 kA	10 kA	10 kA	10 kA	10 kA (type D50 and D63: not tested)
Operational switching capacity	7.5 kA	7.5 kA	7.5 kA	7.5 kA	7.5 kA (type D50 and D63: 6 kA)
Max. back-up fuse [gL/gG]	125 A	125 A	125 A	125 A	125 A
Rated impulse withstand voltage - U _{imp}	4000 V AC	4000 V AC	4000 V AC	4000 V AC	4000 V AC
Rated insulation voltage - U _i	440 V AC	440 V AC	440 V AC	440 V AC	440 V AC
Environmental / General					
Selectivity class	3		3		3
Endurance (operations)	>10000 (1 operation = ON/OFF)		>10000 (1 operation = ON/OFF)		>10000 (1 operation = ON/OFF)
Shock (IEC 68-2-22)	10 g / 120 ms		10 g / 120 ms		10 g / 120 ms
Operating temperature range	-40°C up to +75°C		-40°C up to +75°C		-40°C up to +75°C
Storage- and transport temperature	-40°C up to +75°C		-40°C up to +75°C		-40°C up to +75°C
Mechanical					
Device height	80 mm		80 mm		80 mm
Terminal protection	Finger and back-of-hand proof		Finger and back-of-hand proof		Finger and back-of-hand proof
Mounting width per pole	17.5 mm		17.5 mm		17.5 mm
Mounting	IEC/EN 60715 top-hat rail		IEC/EN 60715 top-hat rail		IEC/EN 60715 top-hat rail
Degree of protection	IP20		IP20		IP20
Terminals top and bottom	Twin-purpose terminals		Twin-purpose terminals		Twin-purpose terminals
Supply connection	Line or load side		Line or load side		Line or load side
Terminal capacity [mm ²]	1 x 25 / 2 x 10		1 x 25 / 2 x 10		1 x 25 / 2 x 10
Torque of terminals	2.4 Nm		2.4 Nm		2.4 Nm
Thickness of busbar material	0.8 - 2 mm		0.8 - 2 mm		0.8 - 2 mm
Mounting position	As required		As required		As required

Technical Data

Electrical	K Characteristic	S Characteristic	Z Characteristic
Approvals	UR (UL 1077), CE	UR (UL 1077), CSA (CSA 22.2 No. 235) for 1-16 A, CE	UR (UL 1077), CE
Standards	IEC/EN 60947-2		
Classified according to	IEC 61373, EN 45545-2		
Current test marks as printed onto the device			
Short-circuit trip response	8–12 I _n	13–17 I _n	2–3 I _n
Supplementary Protectors - UL/CSA			
Current range	1–63 A	1–40 A	0.5–63 A
Maximum voltage ratings - UL/CSA			
Single-pole, single-pole + neutral	277 V AC > 60 V DC	277 V AC > 60 V DC	277 V AC > 60 V DC
Two-, three-, four-pole and three-pole + neutral	480Y/277 V AC	480Y/277 V AC	480Y/277 V AC
Two poles in series	> 125 V DC	> 125 V DC	96 V DC
Thermal tripping characteristics			
Single-pole	< 1 hour @ 1.35 x I _n @ 40°C	< 1 hour @ 1.35 x I _n @ 40°C	< 1 hour @ 1.35 x I _n @ 40°C
Multi-pole	< 1 hour @ 1.45 x I _n @ 40°C	< 1 hour @ 1.45 x I _n @ 40°C	< 1 hour @ 1.45 x I _n @ 40°C
Short-circuit ratings (at max. voltage)			
Single-pole	5 kA @ 277 V AC	5 kA @ 277 V AC	5 kA @ 277 V AC
Single-pole + neutral	5 kA @ 277 V AC	5 kA @ 277 V AC	5 kA @ 277 V AC
Two-, three-, four-pole	5 kA @ 480Y/277 V AC	5 kA @ 480Y/277 V AC	5 kA @ 480Y/277 V AC
Miniature Circuit Breaker - IEC			
Current range	0.5–63 A	0.5–40 A	1–63 A
Maximum voltage ratings - IEC 60947-2			
Single-pole, single-pole + neutral	240 V AC	240 V AC	240 V AC
Single-pole	> 120 V DC	> 120 V DC	> 120 V DC
Two-, three-, four-pole and three-pole + neutral	415 V AC	415 V AC	415 V AC
Thermal tripping characteristics			
	> 1 hour @ 1.05 x I _n @ 40°C	> 1 hour @ 1.05 x I _n @ 40°C	> 1 hour @ 1.05 x I _n @ 40°C
	< 1 hour @ 1.3 x I _n @ 40°C	< 1 hour @ 1.3 x I _n @ 40°C	< 1 hour @ 1.3 x I _n @ 40°C
Interrupt ratings (at max. voltage)			
IEC 60947-2	10 kA	10 kA	10 kA
Operational switching capacity	5 kA	5 kA	5 kA
Max. back-up fuse [gL/gG]	125 A	125 A	125 A
Rated impulse withstand voltage - U _{imp}	4000 V AC	4000 V AC	4000 V AC
Rated insulation voltage - U _i	440 V AC	440 V AC	440 V AC
Environmental / General			
Selectivity class	3	3	3
Endurance (operations)	>10000 (1 operation = ON/OFF)	>10000 (1 operation = ON/OFF)	>10000 (1 operation = ON/OFF)
Shock (IEC 68-2-22)	10 g / 120 ms	10 g / 120 ms	10 g / 120 ms
Operating temperature range	-40°C up to +75°C	-40°C up to +75°C	-40°C up to +75°C
Storage- and transport temperature	-40°C up to +75°C	-40°C up to +75°C	-40°C up to +75°C
Mechanical			
Device height	80 mm	80 mm	80 mm
Terminal protection	Finger and back-of-hand proof	Finger and back-of-hand proof	Finger and back-of-hand proof
Mounting width per pole	17.5 mm	17.5 mm	17.5 mm
Mounting	IEC/EN 60715 top-hat rail	IEC/EN 60715 top-hat rail	IEC/EN 60715 top-hat rail
Degree of protection	IP20	IP20	IP20
Terminals top and bottom	Twin-purpose terminals	Twin-purpose terminals	Twin-purpose terminals
Supply connection	Line or load side	Line or load side	Line or load side
Terminal capacity [mm ²]	1 x 25 / 2 x 10	1 x 25 / 2 x 10	1 x 25 / 2 x 10
Torque of terminals	2.4 Nm	2.4 Nm	2.4 Nm
Thickness of busbar material	0.8 - 2 mm	0.8 - 2 mm	0.8 - 2 mm
Mounting position	As required	As required	As required

Connection diagram

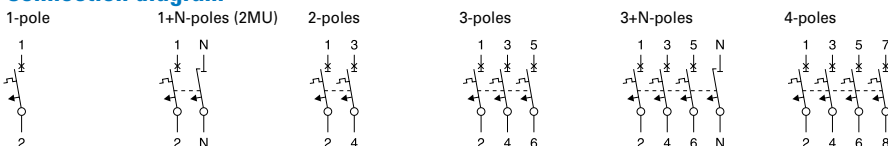

Dimensions (mm) FAZ

1-pole

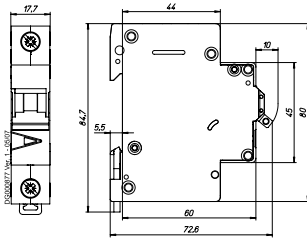

1+N-poles, 2-poles

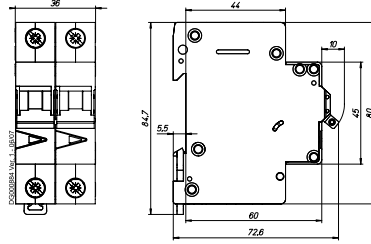

3-poles

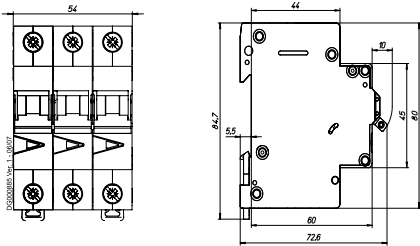

3+N-poles, 4-poles

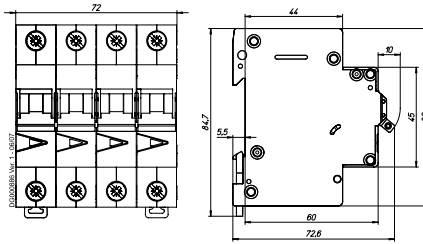

Tripping Characteristics FAZ

Characteristics B, C and D - IEC/EN60898-1

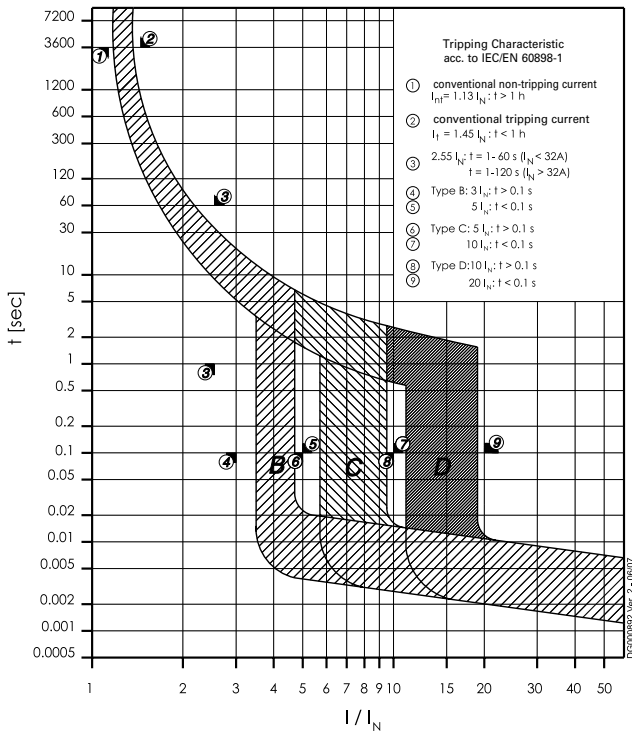

Characteristic K - IEC/EN 60947-2

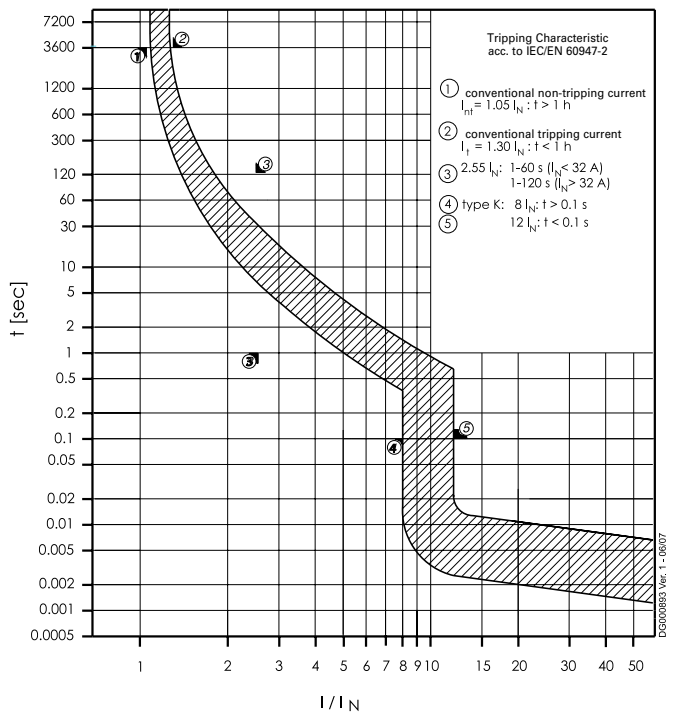

Characteristic S - IEC/EN 60947-2

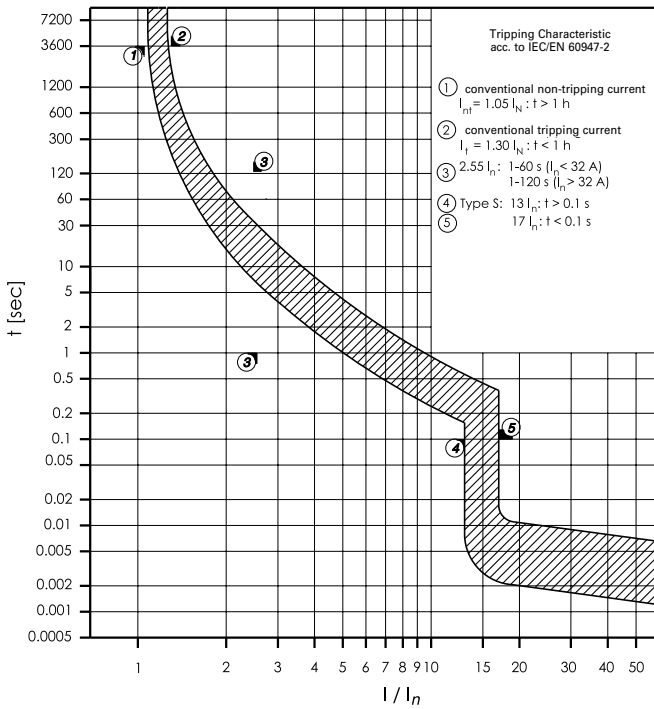

Characteristic S - UL1077

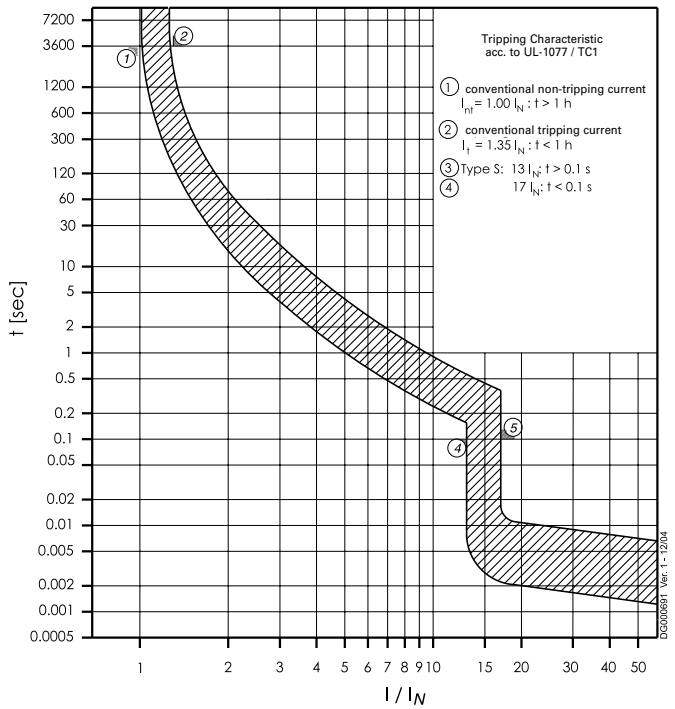

Tripping Characteristics FAZ

Characteristic Z - IEC/EN 60947-2

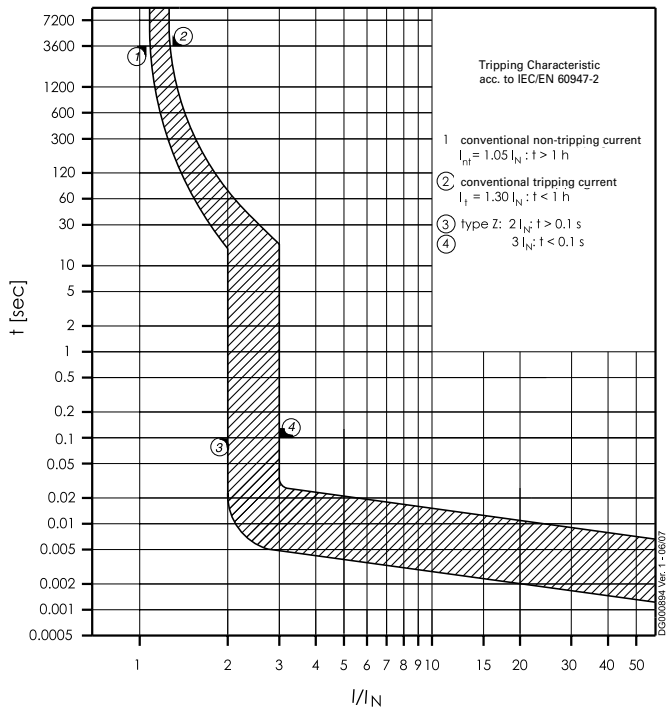

Characteristic Z - UL1077

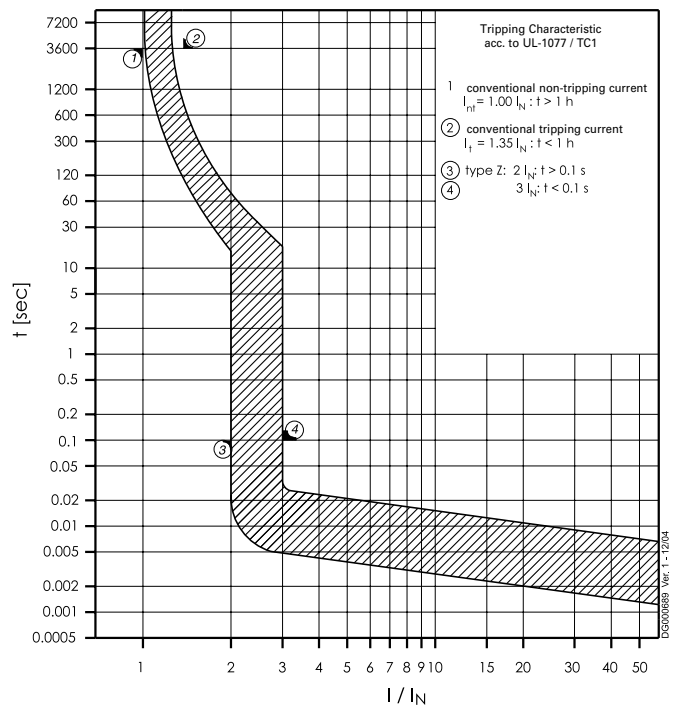

Internal Resistance FAZ

Type B

At room temperature (single pole)

I_n [A]	Z^* [mΩ]	R^* [mΩ]
1	1120	1102
1.5	922	912
1.6	922	912
2	335	333
2.5	234	230
3	211	208
3.5	184	180
4	87.7	87.2
5	73.5	72.8
6	46.8	46.3
8	30.5	30.4
10	17.5	17.4
12	16.9	16.8
13	13.4	13.3
15	8.0	7.9
16	8.0	7.9
20	7.2	7.1
25	5.0	4.9
32	3.7	3.7
40	2.6	2.5
50	2.1	2.1
63	2.0	2.0

* 50 Hz

Type C

At room temperature (single pole)

I_n [A]	Z^* [mΩ]	R^* [mΩ]
0.16	68500	68300
0.25	27500	27400
0.5	4680	4670
0.75	2280	2250
1	1120	1100
1.5	589	587
1.6	589	587
2	335	333
2.5	234	230
3	131	130
3.5	143	141
4	87.7	87.2
5	73.5	72.8
6	39.3	39.1
8	30.5	30.4
10	14.1	14.0
12	13.5	13.4
13	13.4	13.3
15	8.0	7.9
16	8.0	7.9
20	7.2	7.1
25	5.0	4.9
32	3.7	3.7
40	2.6	2.5
50	2.1	2.1
63	2.0	2.0

* 50 Hz

Type D

At room temperature (single pole)

I_n [A]	Z^* [mΩ]	R^* [mΩ]
0.5	4680	4670
1	772	770
1.5	512	508
1.6	512	508
2	250	249
2.5	153	153
3	131	130
3.5	143	141
4	87.7	87.2
5	65.4	65.1
6	39.3	39.1
8	19.5	19.5
10	14.1	14.0
12	11.3	11.2
13	10.1	10.1
15	8.0	7.9
16	8.0	7.9
20	4.9	4.9
25	3.9	3.8
32	3.5	3.4
40	2.7	2.6

* 50 Hz

Fault Loop Impedance FAZ

Max. allowed value for the Fault Loop Impedance Z_s
(acc. to DIN VDE 0100. Teil 410)

$U_0 = 230 \text{ V}$

	Type B		Type C		Type D	
	0.4s	5s	0.4s	5s	0.4s	5s
I_n [A]	Z_s^* [mΩ]	R^* [mΩ]	Z_s^* [mΩ]	R^* [mΩ]	Z_s^* [mΩ]	R^* [mΩ]
1	40.4	40.4	24.3	40.4	12.4	40.4
1.5	26.9	26.9	16.2	26.9	8.3	26.9
2	20.2	20.2	12.2	20.2	6.2	20.2
2.5	16.1	16.1	9.7	16.1	5.0	16.1
3	13.5	13.5	8.1	13.5	4.1	13.5
3.5	11.5	11.5	7.0	11.5	3.6	11.5
4	10.1	10.1	6.1	10.1	3.1	10.1
5	8.1	8.1	4.9	8.1	2.5	8.1
6	6.7	6.7	4.1	6.7	2.1	6.7
8	5.0	5.0	3.0	5.0	1.6	5.0
10	4.0	4.0	2.4	4.0	1.2	4.0
12	3.4	3.4	2.0	3.4	1.0	3.4
13	3.1	3.1	1.9	3.1	1.0	3.1
15	2.7	2.7	1.6	2.7	0.8	2.7
16	2.5	2.5	1.5	2.5	0.8	2.5
20	2.0	2.0	1.2	2.0	0.6	2.0
25	1.6	1.6	1.0	1.6	0.5	1.6
32	1.3	1.3	0.8	1.3	0.4	1.3
40	1.0	1.0	0.6	1.0	0.3	1.0
50	0.8	0.8	0.5	0.8	0.2	0.8
63	0.6	0.6	0.4	0.6	0.2	0.6

$$Z_s = R_{M.C.B.} + R_{Loop}$$

Data/factors taken from the time-current characteristic FAZ

For other rated voltages U_0 :

$U_0 = 240 \text{ V}$: $Z_s^* \cdot 1.04$

$U_0 = 127 \text{ V}$: $Z_s^* \cdot 0.55$

Power Loss at I_n FAZ (50/60 Hz)

Type B					
I_n [A]	1p P [W]	1pN P [W]	2p P [W]	3p P [W]	3pN* P [W]
1	1.6	1.7	3.1	4.7	4.8
1.5	2.3	2.5	4.6	6.9	7.2
1.6	2.5	2.7	4.9	7.4	7.6
2	1.4	1.5	2.8	4.1	4.3
2.5	1.5	1.7	3.1	4.6	4.7
3	2.5	2.7	5.0	7.6	7.8
3.5	2.5	2.8	5.1	7.8	8.0
4	1.4	1.6	2.9	4.4	4.5
5	1.9	2.1	3.8	5.8	6.0
6	1.8	2.0	3.6	5.5	5.6
8	2.1	2.3	4.1	6.3	6.5
10	1.9	2.1	3.9	5.9	6.1
12	2.8	3.2	5.9	8.7	9.0
13	2.5	2.9	5.3	7.8	8.1
15	2.1	2.4	4.4	6.5	6.7
16	2.2	2.6	4.7	6.9	7.2
20	3.2	3.6	6.6	9.8	10.1
25	3.0	3.5	6.4	9.4	9.7
32	3.7	4.4	8.1	12.1	12.5
40	3.4	4.1	7.5	11.2	11.5
50	4.5	5.4	9.9	14.9	15.3
63	5.2	6.3	11.5	17.2	17.7

* symmetrical load

Type C					
I_n [A]	1p P [W]	1pN P [W]	2p P [W]	3p P [W]	3pN* P [W]
0.16	2.2	2.4	4.4	6.7	6.9
0.25	2.0	2.2	4.0	6.1	6.3
0.5	1.2	1.3	2.4	3.5	3.7
0.75	1.3	1.4	2.6	3.9	4.1
1	1.6	1.7	3.1	4.7	4.8
1.5	1.5	1.6	2.9	4.4	4.6
1.6	1.6	1.7	3.1	4.7	4.9
2	1.4	1.5	2.8	4.1	4.3
2.5	1.5	1.7	3.1	4.6	4.7
3	1.2	1.3	2.4	3.6	3.7
3.5	1.3	1.4	2.6	3.9	4.0
4	1.4	1.6	2.9	4.4	4.5
5	1.9	2.1	3.8	5.8	6.0
6	1.5	1.6	2.9	4.4	4.6
8	2.1	2.3	4.1	6.3	6.5
10	1.5	1.7	3.0	4.6	4.7
12	2.1	2.4	4.4	6.5	6.8
13	2.5	2.9	5.3	7.8	8.1
15	2.1	2.4	4.4	6.5	6.7
16	2.2	2.6	4.7	6.9	7.2
20	3.2	3.6	6.6	9.8	10.1
25	3.0	3.5	6.4	9.4	9.7
32	3.7	4.4	8.1	12.1	12.5
40	3.4	4.1	7.5	11.2	11.5
50	4.5	5.4	9.9	14.9	15.3
63	5.2	6.3	11.5	17.2	17.7

* symmetrical load

Type D					
I_n [A]	1p P [W]	1pN P [W]	2p P [W]	3p P [W]	3pN* P [W]
0.5	1.2	1.3	2.4	3.5	3.7
1	0.8	0.9	1.6	2.4	2.5
1.5	1.2	1.3	2.3	3.5	3.6
1.6	1.3	1.4	2.5	3.8	3.9
2	1.0	1.1	2.0	3.0	3.1
2.5	1.0	1.1	1.9	2.9	3.0
3	1.2	1.3	2.4	3.6	3.7
3.5	1.3	1.4	2.6	3.9	4.0
4	1.4	1.6	2.9	4.4	4.5
5	1.7	1.8	3.3	5.1	5.3
6	1.5	1.6	2.9	4.4	4.6
8	1.3	1.5	2.6	4.0	4.2
10	1.5	1.7	3.0	4.6	4.7
12	1.7	2.0	3.6	5.3	5.4
13	1.9	2.2	4.0	5.9	6.1
15	2.1	2.4	4.4	6.5	6.7
16	2.2	2.6	4.7	6.9	7.2
20	2.0	2.2	4.1	6.1	6.2
25	2.5	2.9	5.2	7.7	7.9
32	3.4	4.0	7.4	11.1	11.4
40	3.2	3.8	7.0	10.4	10.7

* symmetrical load

Influence of Ambient Temperature FAZ

On Load Carrying Capacity (temperature derating)

I_n [A]	Ambient temperature T [°C]																
	-40	-30	-20	-10	0	10	20	30	35	40	45	50	55	60	65	70	75
0.16	0.2	0.2	0.19	0.19	0.18	0.17	0.17	0.16	0.16	0.15	0.15	0.15	0.14	0.14	0.14	0.14	0.13
0.25	0.32	0.31	0.3	0.29	0.28	0.27	0.26	0.25	0.25	0.24	0.24	0.23	0.23	0.22	0.22	0.21	0.21
0.5	0.64	0.62	0.6	0.58	0.56	0.54	0.52	0.5	0.49	0.48	0.47	0.46	0.45	0.44	0.43	0.42	0.41
0.75	0.96	0.93	0.9	0.87	0.84	0.81	0.78	0.75	0.74	0.73	0.71	0.69	0.68	0.66	0.65	0.64	0.62
1	1.3	1.2	1.2	1.2	1.1	1.1	1	1	0.99	0.97	0.95	0.93	0.9	0.89	0.87	0.85	0.83
1.5	1.9	1.9	1.8	1.7	1.7	1.6	1.6	1.5	1.5	1.5	1.4	1.4	1.4	1.3	1.3	1.3	1.2
1.6	2	2	1.9	1.9	1.8	1.7	1.7	1.6	1.6	1.5	1.5	1.5	1.4	1.4	1.4	1.4	1.3
2	2.6	2.5	2.4	2.3	2.2	2.2	2.1	2	2	1.9	1.9	1.9	1.8	1.8	1.7	1.7	1.7
2.5	3.2	3.1	3	2.9	2.8	2.7	2.6	2.5	2.5	2.4	2.4	2.3	2.3	2.2	2.2	2.1	2.1
3	3.8	3.7	3.6	3.5	3.4	3.3	3.1	3	3	2.9	2.8	2.8	2.7	2.7	2.6	2.5	2.5
3.5	4.5	4.4	4.2	4.1	3.9	3.8	3.7	3.5	3.4	3.4	3.3	3.2	3.2	3.1	3	3	2.9
4	5.1	5	4.8	4.7	4.5	4.3	4.2	4	3.9	3.9	3.8	3.7	3.6	3.5	3.5	3.4	3.3
5	6.4	6.2	6	5.8	5.6	5.4	5.2	5	4.9	4.8	4.7	4.6	4.5	4.4	4.3	4.2	4.1
6	7.7	7.5	7.2	7	6.7	6.5	6.3	6	5.9	5.8	5.7	5.6	5.4	5.3	5.2	5.1	5
8	10.2	9.9	9.6	9.3	9	8.7	8.4	8	7.9	7.7	7.6	7.4	7.2	7.1	6.9	6.8	6.6
10	13	12	12	12	11	11	10	10	9.9	9.7	9.5	9.3	9	8.9	8.7	8.5	8.3
12	15	15	14	14	13	13	13	12	12	12	11	11	11	11	10	10	10
13	17	16	16	15	15	14	14	13	13	13	12	12	12	12	11	11	11
15	19	19	18	17	17	16	16	15	15	15	14	14	14	13	13	13	12
16	20	20	19	19	18	17	17	16	16	15	15	15	14	14	14	14	13
20	26	25	24	23	22	22	21	20	20	19	19	19	18	18	17	17	17
25	32	31	30	29	28	27	26	25	25	24	24	23	23	22	22	21	21
32	41	40	38	37	36	35	33	32	32	31	30	30	29	28	28	27	26
40	51	50	48	47	45	43	42	40	39	39	38	37	36	35	35	34	33
50	64	62	60	58	56	54	52	50	49	48	47	46	45	44	43	42	41
63	81	78	76	73	71	68	66	63	62	61	60	58	57	56	55	53	52

Maximum Let-Through Energy FAZ

Type B (IEC/EN60947-2)

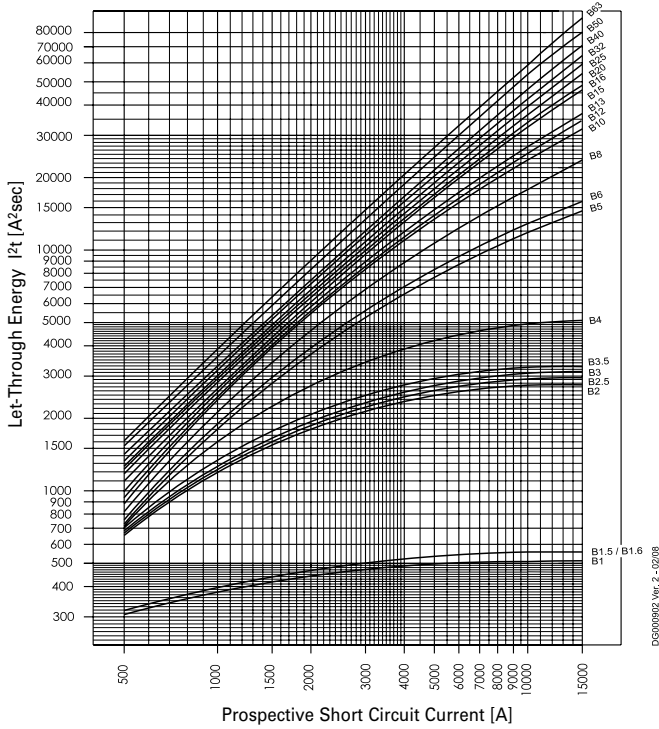

Type C (IEC/EN60947-2)

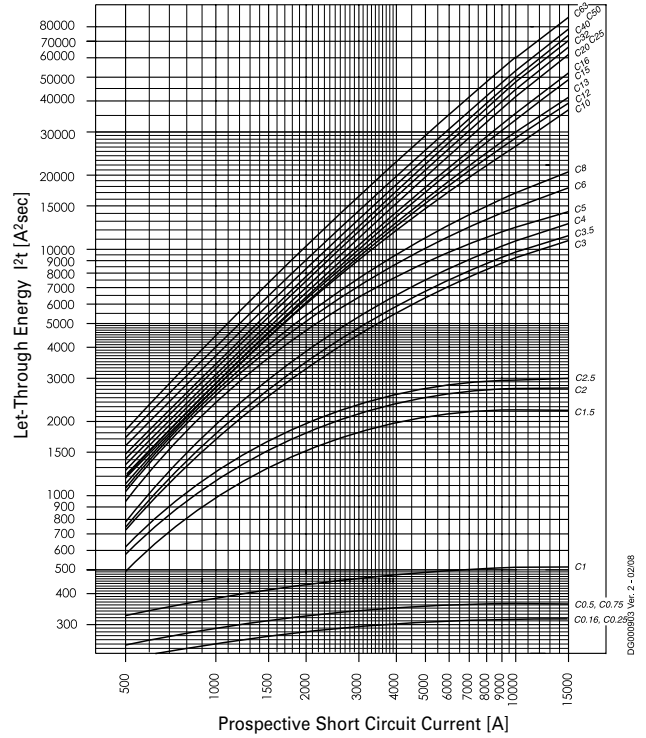

Type D (IEC/EN60947-2)

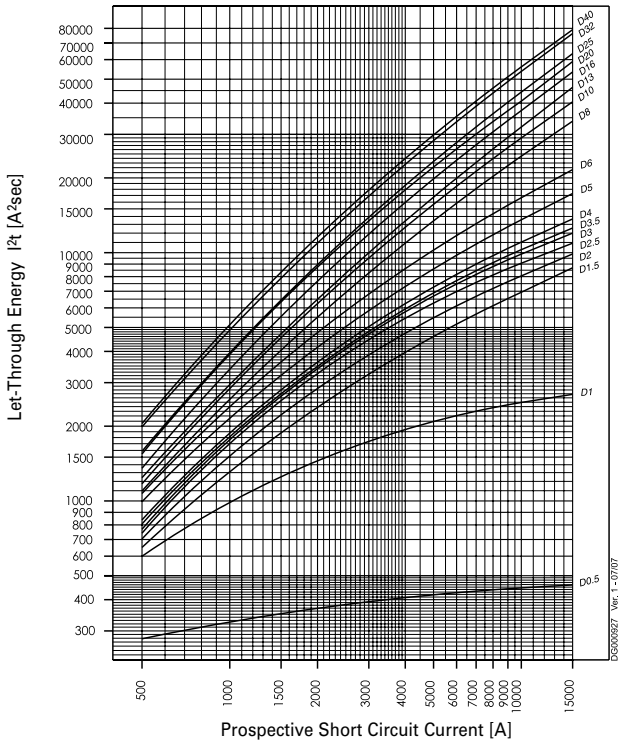

Type K

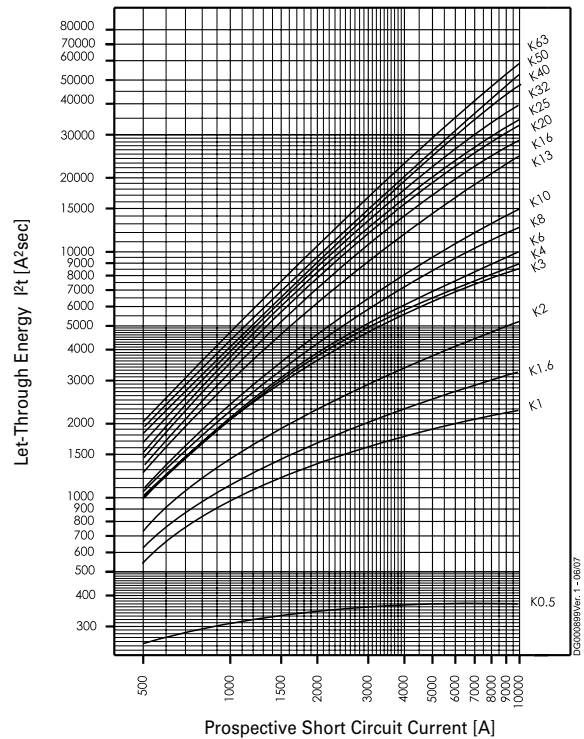

Maximum Let-Through Energy FAZ

Type S

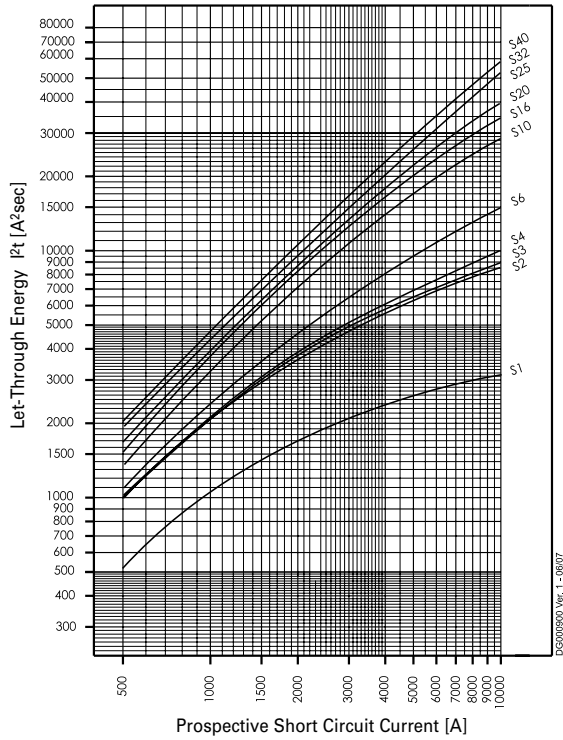

Type Z

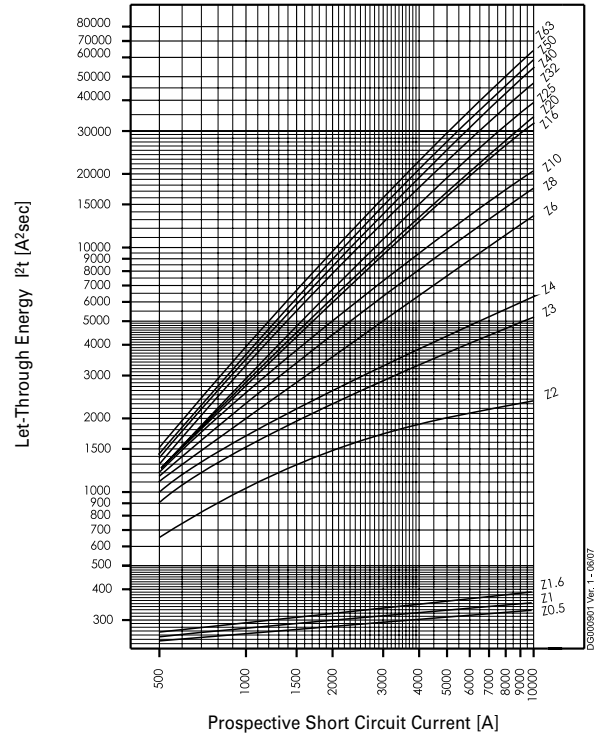

Type FAZ-...-HS

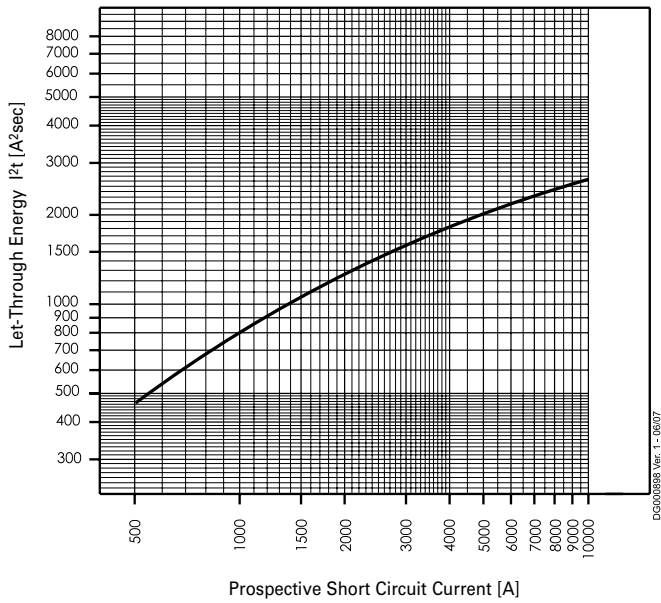

Maximum Let-Through Current FAZ

Type B (IEC/EN60898)

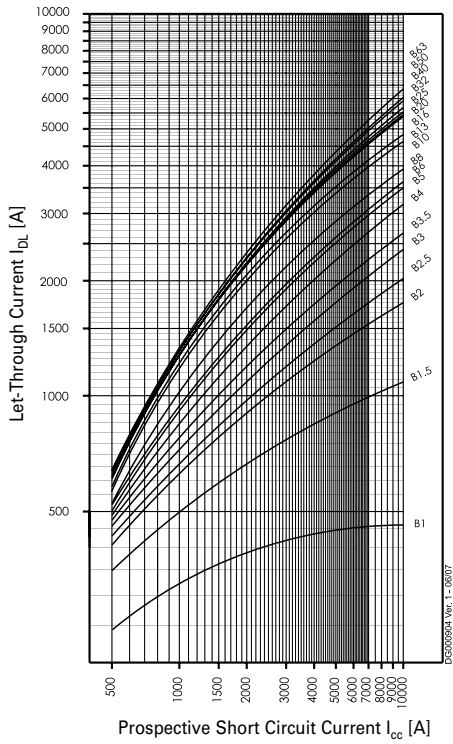

Type C (IEC/EN60898)

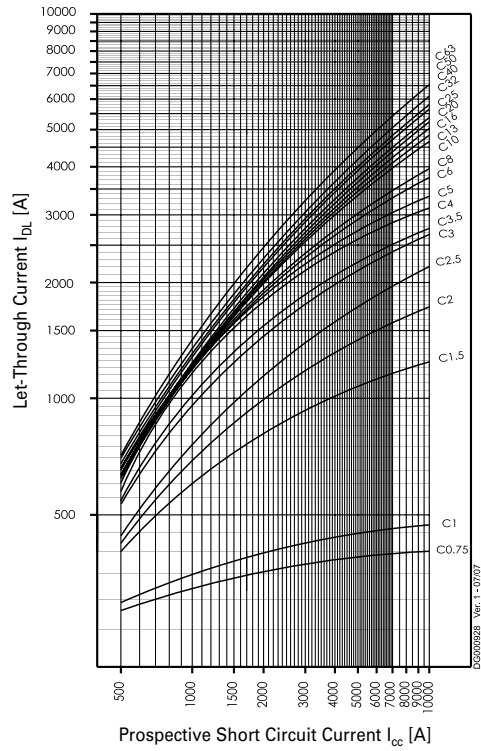

Type D (IEC/EN60898)

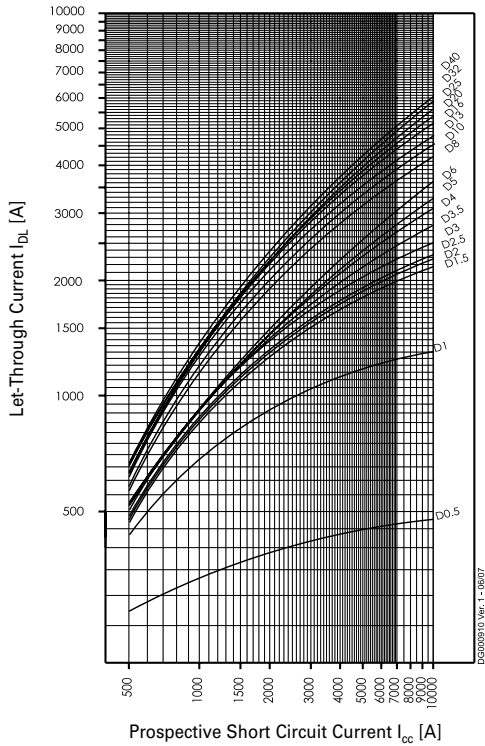

Type K

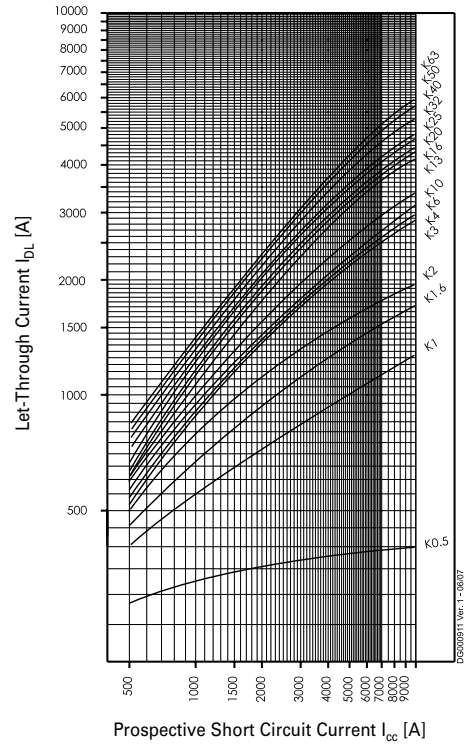

Maximum Let-Through Current FAZ

Type S

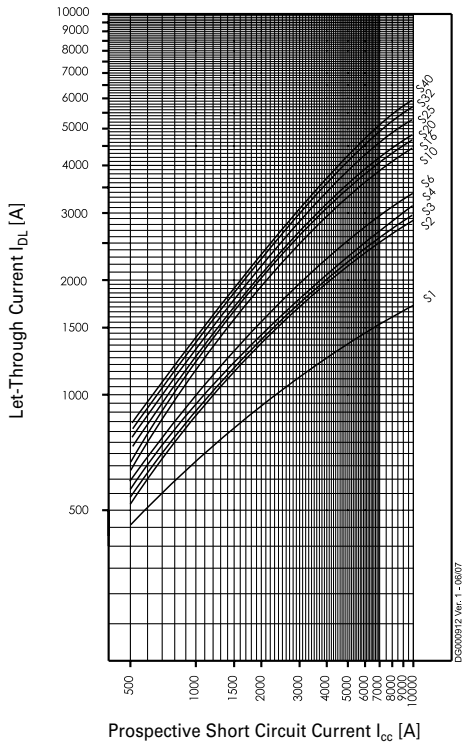

Type B (IEC/EN60947-2)

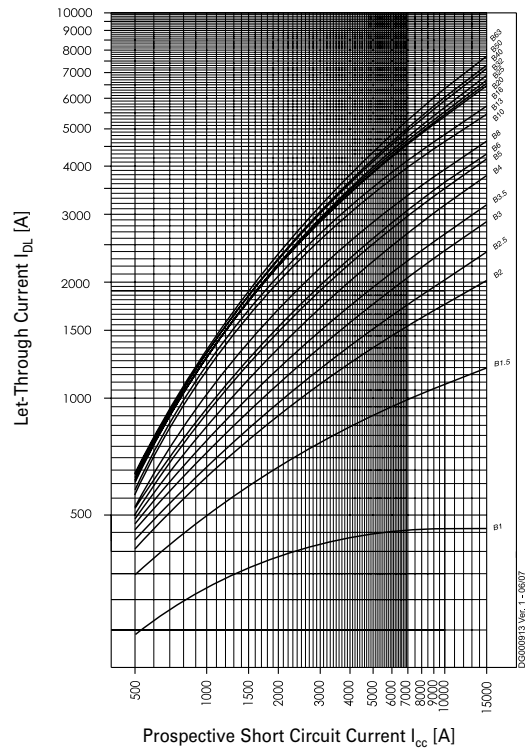

Type C (IEC/EN60947-2)

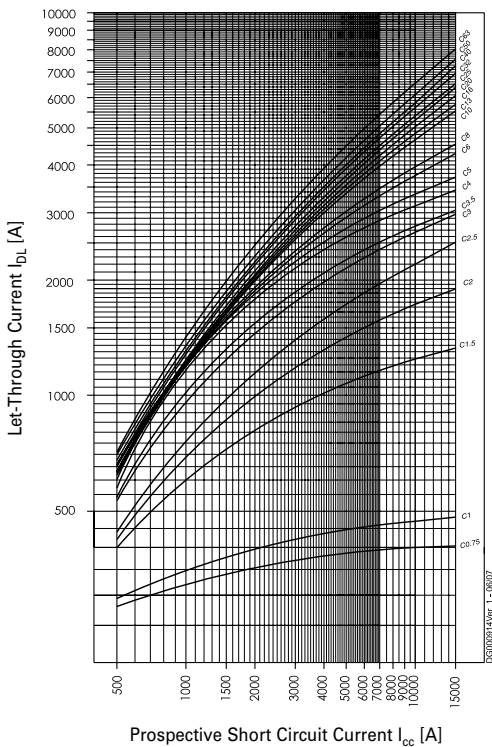

Type D (IEC/EN60947-2)

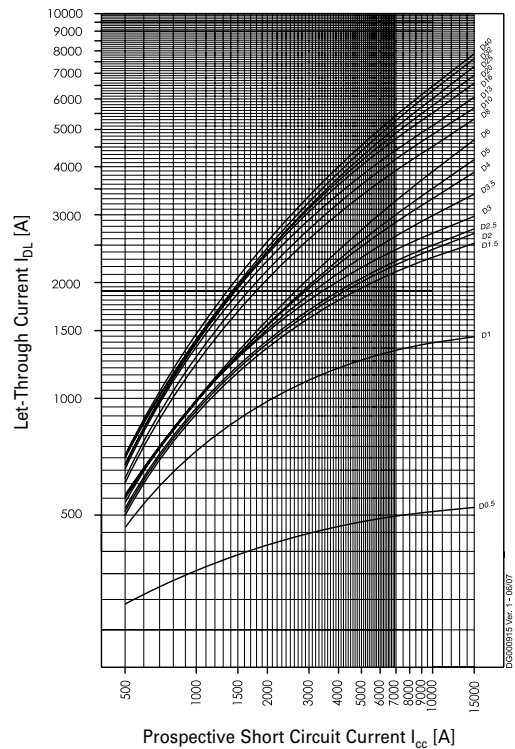

Short Circuit Selectivity FAZ

In case of short circuit, there is selectivity between the miniature circuit breakers FAZ and the upstream protection devices up to the specified values of the selectivity limit current I_s [kA] (i. e. in case of short-circuit currents I_{ks} under I_s , only the MCB will trip, in case of short circuit currents above this value both protective devices will respond).

*) basically in accordance with EN 60898-1 D.5.2.b

FAZ towards NH-00 Fuses

Short circuit selectivity **Characteristic B** towards fuse link **NH-00***)

FAZ	NH-00 gL/gG												
I_n [A]	16	20	25	32	35	40	50	63	80	100	125	160	
1.0	0.9	10.0 ²⁾	10.0 ²⁾	10.0 ²⁾	10.0 ²⁾	10.0 ²⁾	10.0 ²⁾	10.0 ²⁾	10.0 ²⁾	10.0 ²⁾	10.0 ²⁾	10.0 ²⁾	10.0 ²⁾
1.5	0.8	10.0 ²⁾	10.0 ²⁾	10.0 ²⁾	10.0 ²⁾	10.0 ²⁾	10.0 ²⁾	10.0 ²⁾	10.0 ²⁾	10.0 ²⁾	10.0 ²⁾	10.0 ²⁾	10.0 ²⁾
2.0	<0.5 ¹⁾	0.5	1.0	2.5	10.0 ²⁾	10.0 ²⁾	10.0 ²⁾	10.0 ²⁾	10.0 ²⁾	10.0 ²⁾	10.0 ²⁾	10.0 ²⁾	10.0 ²⁾
2.5	<0.5 ¹⁾	0.5	1.0	2.3	10.0 ²⁾	10.0 ²⁾	10.0 ²⁾	10.0 ²⁾	10.0 ²⁾	10.0 ²⁾	10.0 ²⁾	10.0 ²⁾	10.0 ²⁾
3.0	<0.5 ¹⁾	0.5	0.9	2.1	8.0	10.0 ²⁾	10.0 ²⁾	10.0 ²⁾	10.0 ²⁾	10.0 ²⁾	10.0 ²⁾	10.0 ²⁾	10.0 ²⁾
3.5	<0.5 ¹⁾	0.5	0.9	1.8	5.5	10.0 ²⁾	10.0 ²⁾	10.0 ²⁾	10.0 ²⁾	10.0 ²⁾	10.0 ²⁾	10.0 ²⁾	10.0 ²⁾
4	<0.5 ¹⁾	<0.5 ¹⁾	0.8	1.3	2.3	4.3	10.0 ²⁾	10.0 ²⁾	10.0 ²⁾	10.0 ²⁾	10.0 ²⁾	10.0 ²⁾	10.0 ²⁾
5	<0.5 ¹⁾	<0.5 ¹⁾	0.7	1.1	1.6	2.2	3.6	4.8	8.9	10.0 ²⁾	10.0 ²⁾	10.0 ²⁾	10.0 ²⁾
6	<0.5 ¹⁾	<0.5 ¹⁾	0.7	1.1	1.5	2.0	3.3	4.3	7.6	10.0 ²⁾	10.0 ²⁾	10.0 ²⁾	10.0 ²⁾
8	<0.5 ¹⁾	<0.5 ¹⁾	0.6	1.0	1.3	1.7	2.6	3.3	5.2	10.0 ²⁾	10.0 ²⁾	10.0 ²⁾	10.0 ²⁾
10	<0.5 ¹⁾	<0.5 ¹⁾	0.6	0.9	1.2	1.5	2.2	2.7	4.0	9.0	10.0 ²⁾	10.0 ²⁾	10.0 ²⁾
13	<0.5 ¹⁾	<0.5 ¹⁾	0.6	0.8	1.1	1.4	2.1	2.6	3.8	7.9	10.0 ²⁾	10.0 ²⁾	10.0 ²⁾
16	<0.5 ¹⁾	<0.5 ¹⁾	0.6	0.8	1.1	1.4	2.1	2.6	3.8	7.9	10.0 ²⁾	10.0 ²⁾	10.0 ²⁾
20	<0.5 ¹⁾	<0.5 ¹⁾	0.6	0.8	1.1	1.4	2.1	2.6	3.8	7.9	10.0 ²⁾	10.0 ²⁾	10.0 ²⁾
25	<0.5 ¹⁾	<0.5 ¹⁾	0.6	0.8	1.1	1.4	2.1	2.6	3.8	7.9	10.0 ²⁾	10.0 ²⁾	10.0 ²⁾
32	<0.5 ¹⁾	<0.5 ¹⁾	0.6	0.8	1.1	1.4	2.1	2.6	3.8	7.9	10.0 ²⁾	10.0 ²⁾	10.0 ²⁾
40	<0.5 ¹⁾	<0.5 ¹⁾	0.6	0.8	1.1	1.4	2.1	2.6	3.8	7.9	10.0 ²⁾	10.0 ²⁾	10.0 ²⁾
50	<0.5 ¹⁾	<0.5 ¹⁾	0.6	0.8	1.1	1.4	2.1	2.6	3.8	7.9	10.0 ²⁾	10.0 ²⁾	10.0 ²⁾
63	<0.5 ¹⁾	<0.5 ¹⁾	0.6	0.8	1.1	1.4	2.1	2.6	3.8	7.9	10.0 ²⁾	10.0 ²⁾	10.0 ²⁾

Short circuit selectivity **Characteristic C** towards fuse link **NH-00***)

FAZ	NH-00 gL/gG												
I_n [A]	16	20	25	32	35	40	50	63	80	100	125	160	
0.75	10.0 ²⁾	10.0 ²⁾	10.0 ²⁾	10.0 ²⁾	10.0 ²⁾	10.0 ²⁾	10.0 ²⁾	10.0 ²⁾	10.0 ²⁾	10.0 ²⁾	10.0 ²⁾	10.0 ²⁾	10.0 ²⁾
1.0	0.9	10.0 ²⁾	10.0 ²⁾	10.0 ²⁾	10.0 ²⁾	10.0 ²⁾	10.0 ²⁾	10.0 ²⁾	10.0 ²⁾	10.0 ²⁾	10.0 ²⁾	10.0 ²⁾	10.0 ²⁾
1.5	<0.5 ¹⁾	0.6	1.3	4.2	10.0 ²⁾	10.0 ²⁾	10.0 ²⁾	10.0 ²⁾	10.0 ²⁾	10.0 ²⁾	10.0 ²⁾	10.0 ²⁾	10.0 ²⁾
2.0	<0.5 ¹⁾	0.6	1.0	2.5	10.0 ²⁾	10.0 ²⁾	10.0 ²⁾	10.0 ²⁾	10.0 ²⁾	10.0 ²⁾	10.0 ²⁾	10.0 ²⁾	10.0 ²⁾
2.5	<0.5 ¹⁾	0.5	1.0	2.1	10.0 ²⁾	10.0 ²⁾	10.0 ²⁾	10.0 ²⁾	10.0 ²⁾	10.0 ²⁾	10.0 ²⁾	10.0 ²⁾	10.0 ²⁾
3.0	<0.5 ¹⁾	<0.5 ¹⁾	0.7	1.2	1.8	2.6	4.7	6.6	10.0 ²⁾	10.0 ²⁾	10.0 ²⁾	10.0 ²⁾	10.0 ²⁾
3.5	<0.5 ¹⁾	<0.5 ¹⁾	0.7	1.1	1.7	2.4	4.2	6.0	10.0 ²⁾	10.0 ²⁾	10.0 ²⁾	10.0 ²⁾	10.0 ²⁾
4	<0.5 ¹⁾	<0.5 ¹⁾	0.7	1.0	1.5	2.1	3.6	5.0	10.0	10.0 ²⁾	10.0 ²⁾	10.0 ²⁾	10.0 ²⁾
5	<0.5 ¹⁾	<0.5 ¹⁾	0.6	0.8	1.2	1.7	2.8	3.8	8.7	10.0 ²⁾	10.0 ²⁾	10.0 ²⁾	10.0 ²⁾
6	<0.5 ¹⁾	<0.5 ¹⁾	0.5	0.8	1.2	1.5	2.5	3.3	5.7	10.0 ²⁾	10.0 ²⁾	10.0 ²⁾	10.0 ²⁾
8	<0.5 ¹⁾	<0.5 ¹⁾	0.5	0.8	1.1	1.5	2.3	2.9	4.9	10.0 ²⁾	10.0 ²⁾	10.0 ²⁾	10.0 ²⁾
10	<0.5 ¹⁾	<0.5 ¹⁾	0.5	0.7	1.0	1.4	2.0	2.5	3.8	8.0	10.0 ²⁾	10.0 ²⁾	10.0 ²⁾
13	<0.5 ¹⁾	<0.5 ¹⁾	0.5	0.7	1.0	1.4	2.0	2.5	3.8	8.0	10.0 ²⁾	10.0 ²⁾	10.0 ²⁾
16	<0.5 ¹⁾	<0.5 ¹⁾	0.5	0.7	1.0	1.4	2.0	2.5	3.8	8.0	10.0 ²⁾	10.0 ²⁾	10.0 ²⁾
20	<0.5 ¹⁾	<0.5 ¹⁾	0.5	0.7	1.0	1.4	2.0	2.5	3.8	8.0	10.0 ²⁾	10.0 ²⁾	10.0 ²⁾
25	<0.5 ¹⁾	<0.5 ¹⁾	0.5	0.7	1.0	1.4	2.0	2.5	3.8	8.0	10.0 ²⁾	10.0 ²⁾	10.0 ²⁾
32	<0.5 ¹⁾	<0.5 ¹⁾	0.5	0.7	1.0	1.4	2.0	2.5	3.8	8.0	10.0 ²⁾	10.0 ²⁾	10.0 ²⁾
40	<0.5 ¹⁾	<0.5 ¹⁾	0.5	0.7	1.0	1.4	2.0	2.5	3.8	8.0	10.0 ²⁾	10.0 ²⁾	10.0 ²⁾
50	<0.5 ¹⁾	<0.5 ¹⁾	0.5	0.7	1.0	1.4	2.0	2.5	3.8	8.0	10.0 ²⁾	10.0 ²⁾	10.0 ²⁾
63	<0.5 ¹⁾	<0.5 ¹⁾	0.5	0.7	1.0	1.4	2.0	2.5	3.8	8.0	10.0 ²⁾	10.0 ²⁾	10.0 ²⁾

Short circuit selectivity **Characteristic D** towards fuse link **NH-00***)

FAZ	NH-00 gL/gG												
I_n [A]	16	20	25	32	35	40	50	63	80	100	125	160	
0.5	2.1	10.0 ²⁾	10.0 ²⁾	10.0 ²⁾	10.0 ²⁾	10.0 ²⁾	10.0 ²⁾	10.0 ²⁾	10.0 ²⁾	10.0 ²⁾	10.0 ²⁾	10.0 ²⁾	
1.0	<0.5 ¹⁾	0.6	1.4	4.3	10.0 ²⁾	10.0 ²⁾	10.0 ²⁾	10.0 ²⁾	10.0 ²⁾	10.0 ²⁾	10.0 ²⁾	10.0 ²⁾	
1.5	<0.5 ¹⁾	<0.5 ¹⁾	0.9	1.6	2.7	4.0	8.0	10.0 ²⁾	10.0 ²⁾	10.0 ²⁾	10.0 ²⁾	10.0 ²⁾	
2.0	<0.5 ¹⁾	<0.5 ¹⁾	0.8	1.3	2.1	3.1	6.0	8.6	10.0 ²⁾	10.0 ²⁾	10.0 ²⁾	10.0 ²⁾	
2.5	<0.5 ¹⁾	<0.5 ¹⁾	0.7	1.2	1.8	2.6	4.8	6.9	10.0 ²⁾	10.0 ²⁾	10.0 ²⁾	10.0 ²⁾	
3.0	<0.5 ¹⁾	<0.5 ¹⁾	0.7	1.1	1.7	2.4	4.3	6.0	10.0 ²⁾	10.0 ²⁾	10.0 ²⁾	10.0 ²⁾	
3.5	<0.5 ¹⁾	<0.5 ¹⁾	0.7	1.1	1.7	2.4	4.2	5.6	10.0 ²⁾	10.0 ²⁾	10.0 ²⁾	10.0 ²⁾	
4	<0.5 ¹⁾	<0.5 ¹⁾	0.7	1.0	1.6	2.2	3.8	5.2	10.0	10.0 ²⁾	10.0 ²⁾	10.0 ²⁾	
5	<0.5 ¹⁾	<0.5 ¹⁾	0.6	0.9	1.4	1.9	3.2	4.1	7.1	10.0 ²⁾	10.0 ²⁾	10.0 ²⁾	
6	<0.5 ¹⁾	<0.5 ¹⁾	0.5	0.8	1.2	1.6	2.6	3.3	5.5	10.0 ²⁾	10.0 ²⁾	10.0 ²⁾	
8	<0.5 ¹⁾	<0.5 ¹⁾	0.5	0.8	1.1	1.5	2.2	2.7	4.1	8.7	10.0 ²⁾	10.0 ²⁾	
10	<0.5 ¹⁾	<0.5 ¹⁾	0.5	0.7	1.0	1.3	1.9	2.5	3.6	7.2	10.0 ²⁾	10.0 ²⁾	
13	<0.5 ¹⁾	<0.5 ¹⁾	0.5	0.7	1.0	1.3	1.9	2.3	3.4	6.5	9.5	10.0 ²⁾	
16	<0.5 ¹⁾	<0.5 ¹⁾	0.5	0.7	1.0	1.3	1.9	2.3	3.4	6.5	9.5	10.0 ²⁾	
20	<0.5 ¹⁾	<0.5 ¹⁾	0.5	0.7	1.0	1.3	1.9	2.3	3.4	6.5	9.5	10.0 ²⁾	
25	<0.5 ¹⁾	<0.5 ¹⁾	0.5	0.7	1.0	1.3	1.9	2.3	3.4	6.5	9.5	10.0 ²⁾	
32	<0.5 ¹⁾	<0.5 ¹⁾	0.5	0.7	1.0	1.3	1.9	2.3	3.4	6.5	9.5	10.0 ²⁾	
40	<0.5 ¹⁾	<0.5 ¹⁾	0.5	0.7	1.0	1.3	1.9	2.3	3.4	6.5	9.5	10.0 ²⁾	

¹⁾ Selectivity limiting current I_s under 0.5 kA
²⁾ Selectivity limiting current I_s = rated breaking capacity I_{cn} of the MCB
 Shaded fields: no selectivity

FAZ towards D01-D03 Fuses

 Short circuit selectivity **Characteristic B** towards fuse link **D01-D03***

FAZ	D01-D03 gL/gG									
I_n [A]	10	16	20	25	35	50	63	80	100	
1.0	<0.5 ¹⁾	10.0 ²⁾	10.0 ²⁾	10.0 ²⁾	10.0 ²⁾	10.0 ²⁾	10.0 ²⁾	10.0 ²⁾	10.0 ²⁾	
1.5	<0.5 ¹⁾	4.1	10.0 ²⁾	10.0 ²⁾	10.0 ²⁾	10.0 ²⁾	10.0 ²⁾	10.0 ²⁾	10.0 ²⁾	
2.0	<0.5 ¹⁾	<0.5 ¹⁾	0.6	1.0	10.0 ²⁾	10.0 ²⁾	10.0 ²⁾	10.0 ²⁾	10.0 ²⁾	
2.5	<0.5 ¹⁾	<0.5 ¹⁾	0.6	1.0	10.0 ²⁾	10.0 ²⁾	10.0 ²⁾	10.0 ²⁾	10.0 ²⁾	
3.0	<0.5 ¹⁾	<0.5 ¹⁾	0.5	1.0	10.0 ²⁾	10.0 ²⁾	10.0 ²⁾	10.0 ²⁾	10.0 ²⁾	
3.5	<0.5 ¹⁾	<0.5 ¹⁾	0.5	0.9	7.0	10.0 ²⁾	10.0 ²⁾	10.0 ²⁾	10.0 ²⁾	
4	<0.5 ¹⁾	<0.5 ¹⁾	0.5	0.9	2.5	10.0 ²⁾	10.0 ²⁾	10.0 ²⁾	10.0 ²⁾	
5		<0.5 ¹⁾	0.5	0.8	1.7	4.0	7.0	10.0 ²⁾	10.0 ²⁾	
6		<0.5 ¹⁾	0.5	0.8	1.6	3.6	6.0	10.0 ²⁾	10.0 ²⁾	
8			0.5	0.8	1.4	2.8	4.3	8.2	10.0 ²⁾	
10			0.5	0.7	1.3	2.4	3.4	6.0	10.0 ²⁾	
13			<0.5 ¹⁾	0.7	1.2	2.3	3.2	5.3	10.0 ²⁾	
16				0.6	1.1	2.2	2.9	4.6	10.0	
20					1.1	2.1	2.8	4.4	9.3	
25						1.1	2.0	2.7	4.2	8.7
32							2.0	2.6	4.0	8.0
40								2.5	3.8	7.5
50								2.3	3.4	6.7
63										6.2

 Short circuit selectivity **Characteristic C** towards fuse link **D01-D03***

FAZ	D01-D03 gL/gG										
I_n [A]	10	16	20	25	35	50	63	80	100		
0.75	<0.5 ¹⁾	10.0 ²⁾	10.0 ²⁾	10.0 ²⁾	10.0 ²⁾	10.0 ²⁾	10.0 ²⁾	10.0 ²⁾	10.0 ²⁾		
1.0	<0.5 ¹⁾	10.0 ²⁾	10.0 ²⁾	10.0 ²⁾	10.0 ²⁾	10.0 ²⁾	10.0 ²⁾	10.0 ²⁾	10.0 ²⁾		
1.5	<0.5 ¹⁾	0.5	0.6	0.9	10.0 ²⁾	10.0 ²⁾	10.0 ²⁾	10.0 ²⁾	10.0 ²⁾		
2.0	<0.5 ¹⁾	<0.5 ¹⁾	0.5	0.7	10.0 ²⁾	10.0 ²⁾	10.0 ²⁾	10.0 ²⁾	10.0 ²⁾		
2.5	<0.5 ¹⁾	<0.5 ¹⁾	0.5	0.7	10.0 ²⁾	10.0 ²⁾	10.0 ²⁾	10.0 ²⁾	10.0 ²⁾		
3.0	<0.5 ¹⁾	<0.5 ¹⁾	<0.5 ¹⁾	0.6	1.9	5.2	10.0 ²⁾	10.0 ²⁾	10.0 ²⁾		
3.5	<0.5 ¹⁾	<0.5 ¹⁾	<0.5 ¹⁾	0.6	1.8	4.7	9.5	10.0 ²⁾	10.0 ²⁾		
4	<0.5 ¹⁾	<0.5 ¹⁾	<0.5 ¹⁾	0.6	1.6	4.0	7.6	10.0 ²⁾	10.0 ²⁾		
5		<0.5 ¹⁾	<0.5 ¹⁾	0.5	1.3	3.1	5.7	10.0 ²⁾	10.0 ²⁾		
6		<0.5 ¹⁾	<0.5 ¹⁾	<0.5 ¹⁾	1.2	2.7	4.5	10.0 ²⁾	10.0 ²⁾		
8		<0.5 ¹⁾	<0.5 ¹⁾	<0.5 ¹⁾	1.2	2.5	4.0	8.6	10.0 ²⁾		
10			<0.5 ¹⁾	<0.5 ¹⁾	1.2	2.3	3.1	5.4	10.0 ²⁾		
13					1.1	2.2	3.0	4.9	10.0 ²⁾		
16						1.1	2.1	2.8	4.4	9.5	
20							1.0	2.0	2.6	4.0	8.3
25								1.9	2.5	3.8	7.8
32									2.5	3.7	7.3
40										3.5	7.0
50											6.5
63											

 Short circuit selectivity **Characteristic D** towards fuse link **D01-D03***

FAZ	D01-D03 gL/gG									
I_n [A]	10	16	20	25	35	50	63	80	100	
0.5	<0.5 ¹⁾	10.0 ²⁾	10.0 ²⁾	10.0 ²⁾	10.0 ²⁾	10.0 ²⁾	10.0 ²⁾	10.0 ²⁾	10.0 ²⁾	
1.0	<0.5 ¹⁾	<0.5 ¹⁾	0.7	1.3	10.0 ²⁾	10.0 ²⁾	10.0 ²⁾	10.0 ²⁾	10.0 ²⁾	
1.5	<0.5 ¹⁾	<0.5 ¹⁾	0.6	0.9	2.8	9.0	10.0 ²⁾	10.0 ²⁾	10.0 ²⁾	
2.0	<0.5 ¹⁾	<0.5 ¹⁾	0.6	0.8	2.2	6.7	10.0 ²⁾	10.0 ²⁾	10.0 ²⁾	
2.5	<0.5 ¹⁾	<0.5 ¹⁾	0.5	0.7	1.9	5.4	10.0 ²⁾	10.0 ²⁾	10.0 ²⁾	
3.0	<0.5 ¹⁾	<0.5 ¹⁾	0.5	0.7	1.8	4.8	9.3	10.0 ²⁾	10.0 ²⁾	
3.5	<0.5 ¹⁾	<0.5 ¹⁾	0.5	0.7	1.7	4.7	8.6	10.0 ²⁾	10.0 ²⁾	
4		<0.5 ¹⁾	0.5	0.7	1.7	4.6	7.7	10.0 ²⁾	10.0 ²⁾	
5		<0.5 ¹⁾	<0.5 ¹⁾	0.6	1.5	3.5	5.8	10.0 ²⁾	10.0 ²⁾	
6			<0.5 ¹⁾	0.5	1.3	2.9	4.5	9.0	10.0 ²⁾	
8			<0.5 ¹⁾	0.5	1.2	2.4	3.5	6.0	10.0 ²⁾	
10				0.5	1.1	2.2	3.0	5.0	10.0 ²⁾	
13					1.1	2.1	2.9	4.6	10.0 ²⁾	
16						1.9	2.6	3.9	9.0	
20							1.7	2.3	3.5	8.0
25								2.2	3.4	7.5
32									2.9	6.0
40										5.7

 1) Selectivity limiting current I_s under 0.5 kA

 2) Selectivity limiting current I_s = rated breaking capacity I_{cn} of the MCB

Shaded fields: no selectivity

FAZ towards DII-DIV Fuses

Short circuit selectivity **Characteristic B** towards fuse link **DII-DIV***)

FAZ	DII-DIV gL/gG								
I _n [A]	10	16	20	25	35	50	63	80	100
1.0	<0.5 ¹⁾	1.2	10.0 ²⁾	10.0 ²⁾	10.0 ²⁾	10.0 ²⁾	10.0 ²⁾	10.0 ²⁾	10.0 ²⁾
1.5	<0.5 ¹⁾	1.0	10.0 ²⁾	10.0 ²⁾	10.0 ²⁾	10.0 ²⁾	10.0 ²⁾	10.0 ²⁾	10.0 ²⁾
2.0	<0.5 ¹⁾	<0.5 ¹⁾	0.8	1.6	10.0 ²⁾	10.0 ²⁾	10.0 ²⁾	10.0 ²⁾	10.0 ²⁾
2.5	<0.5 ¹⁾	<0.5 ¹⁾	0.8	1.5	10.0 ²⁾	10.0 ²⁾	10.0 ²⁾	10.0 ²⁾	10.0 ²⁾
3.0	<0.5 ¹⁾	<0.5 ¹⁾	0.8	1.4	10.0 ²⁾	10.0 ²⁾	10.0 ²⁾	10.0 ²⁾	10.0 ²⁾
3.5	<0.5 ¹⁾	<0.5 ¹⁾	0.7	1.3	10.0 ²⁾	10.0 ²⁾	10.0 ²⁾	10.0 ²⁾	10.0 ²⁾
4	<0.5 ¹⁾	<0.5 ¹⁾	0.6	1.0	3.6	10.0 ²⁾	10.0 ²⁾	10.0 ²⁾	10.0 ²⁾
5	<0.5 ¹⁾	<0.5 ¹⁾	0.6	0.9	2.0	3.5	8.5	10.0 ²⁾	10.0 ²⁾
6		<0.5 ¹⁾	0.6	0.9	1.8	3.2	7.4	10.0 ²⁾	10.0 ²⁾
8		<0.5 ¹⁾	0.5	0.8	1.6	2.6	5.2	8.3	10.0 ²⁾
10			0.5	0.8	1.4	2.2	3.9	6.0	10.0 ²⁾
13			0.5	0.7	1.3	2.0	3.6	5.4	10.0 ²⁾
16				0.6	1.2	1.9	3.2	4.6	8.4
20					1.2	1.8	3.1	4.4	7.8
25					1.2	1.8	3.0	4.2	7.3
32						1.7	2.8	3.9	6.8
40							2.7	3.8	6.5
50							2.5	3.5	5.7
63									5.3

Short circuit selectivity **Characteristic C** towards fuse link **DII-DIV***)

FAZ	DII-DIV gL/gG								
I _n [A]	10	16	20	25	35	50	63	80	100
0.75	1.0	10.0 ²⁾	10.0 ²⁾	10.0 ²⁾	10.0 ²⁾	10.0 ²⁾	10.0 ²⁾	10.0 ²⁾	10.0 ²⁾
1.0	<0.5 ¹⁾	1.2	10.0 ²⁾	10.0 ²⁾	10.0 ²⁾	10.0 ²⁾	10.0 ²⁾	10.0 ²⁾	10.0 ²⁾
1.5	<0.5 ¹⁾	<0.5 ¹⁾	1.0	2.2	10.0 ²⁾	10.0 ²⁾	10.0 ²⁾	10.0 ²⁾	10.0 ²⁾
2.0	<0.5 ¹⁾	<0.5 ¹⁾	0.8	1.6	10.0 ²⁾	10.0 ²⁾	10.0 ²⁾	10.0 ²⁾	10.0 ²⁾
2.5	<0.5 ¹⁾	<0.5 ¹⁾	0.8	1.4	10.0 ²⁾	10.0 ²⁾	10.0 ²⁾	10.0 ²⁾	10.0 ²⁾
3.0	<0.5 ¹⁾	<0.5 ¹⁾	0.8	0.9	10.0 ²⁾	10.0 ²⁾	10.0 ²⁾	10.0 ²⁾	10.0 ²⁾
3.5	<0.5 ¹⁾	<0.5 ¹⁾	0.6	0.9	2.2	4.5	10.0 ²⁾	10.0 ²⁾	10.0 ²⁾
4	<0.5 ¹⁾	<0.5 ¹⁾	0.6	0.8	1.8	3.6	9.7	10.0 ²⁾	10.0 ²⁾
5	<0.5 ¹⁾	<0.5 ¹⁾	0.6	0.7	1.5	2.7	7.3	10.0 ²⁾	10.0 ²⁾
6		<0.5 ¹⁾	0.5	0.6	1.4	2.4	5.5	10.0 ²⁾	10.0 ²⁾
8		<0.5 ¹⁾	<0.5 ¹⁾	0.6	1.3	2.2	4.7	8.7	10.0 ²⁾
10			<0.5 ¹⁾	0.6	1.3	2.0	3.6	5.4	10.0 ²⁾
13					1.3	1.9	3.3	5.0	9.4
16					1.2	1.8	3.2	4.4	8.0
20					1.2	1.8	3.1	4.1	7.0
25						1.7	2.8	3.8	6.5
32							2.7	3.7	6.2
40								3.5	5.9
50									5.5
63									

Short circuit selectivity **Characteristic D** towards fuse link **DII-DIV***)

FAZ	DII-DIV gL/gG								
I _n [A]	10	16	20	25	35	50	63	80	100
0.5	0.5	3.0	10.0 ²⁾	10.0 ²⁾	10.0 ²⁾	10.0 ²⁾	10.0 ²⁾	10.0 ²⁾	10.0 ²⁾
1.0	<0.5 ¹⁾	<0.5 ¹⁾	1.0	2.4	10.0 ²⁾	10.0 ²⁾	10.0 ²⁾	10.0 ²⁾	10.0 ²⁾
1.5	<0.5 ¹⁾	<0.5 ¹⁾	0.7	1.2	3.5	7.7	10.0 ²⁾	10.0 ²⁾	10.0 ²⁾
2.0	<0.5 ¹⁾	<0.5 ¹⁾	0.6	1.0	2.8	5.8	10.0 ²⁾	10.0 ²⁾	10.0 ²⁾
2.5	<0.5 ¹⁾	<0.5 ¹⁾	0.6	1.4	2.3	4.6	10.0 ²⁾	10.0 ²⁾	10.0 ²⁾
3.0	<0.5 ¹⁾	<0.5 ¹⁾	0.6	0.9	2.3	4.3	10.0 ²⁾	10.0 ²⁾	10.0 ²⁾
3.5	<0.5 ¹⁾	<0.5 ¹⁾	0.6	0.9	2.1	4.0	10.0 ²⁾	10.0 ²⁾	10.0 ²⁾
4		<0.5 ¹⁾	0.6	0.9	2.0	3.8	9.5	10.0 ²⁾	10.0 ²⁾
5		<0.5 ¹⁾	0.5	0.7	1.7	3.1	7.0	10.0 ²⁾	10.0 ²⁾
6			0.5	0.7	1.5	2.6	5.3	9.1	10.0 ²⁾
8			<0.5 ¹⁾	0.7	1.4	2.2	3.9	6.0	10.0 ²⁾
10				0.7	1.2	1.9	3.4	5.0	9.5
13					1.2	1.8	3.2	4.6	8.6
16						1.6	2.7	4.0	7.4
20						1.5	2.5	3.5	6.7
25							2.4	3.4	6.2
32								2.8	5.0
40									4.8

¹⁾ Selectivity limiting current I_s under 0.5 kA

²⁾ Selectivity limiting current I_s = rated breaking capacity I_{cn} of the MCB

Shaded fields: no selectivity

FAZ-B and NZM 1/2

Selectivity limiting current I_s [kA] for selectivity between FAZ-B and NZM (overload and short-circuit release unit NZM at max. value).

FAZ-B	NZM...1-A... $I_{cu} = 25 (50) \text{ kA}$						FAZ-B	NZM...2-A... $I_{cu} = 25 (50)(100)(150) \text{ kA}$									
	40	50	63	80	100	125		40	50	63	80	100	125	160	200	250	
1	15	15	15	15	15	15	1	15	15	15	15	15	15	15	15	15	
2	2	15	15	15	15	15	2	3	15	15	15	15	15	15	15	15	
3	1.2	2	3	3	10	15	3	1.5	1.5	3	5	15	15	15	15	15	
4	1.2	2	3	3	8	15	4	1.2	1.5	3	4	15	15	15	15	15	
6	1.2	2	2.5	3	5	10	6	1.2	1.5	2.5	3	15	15	15	15	15	
10	1.2	1.5	2	2	4	10	10	1	1.5	2.5	3	10	10	10	10	10	
13	1	1.5	2	2	4	10	13	1	1.2	2	3	10	10	10	10	10	
16	1	1.2	1.5	2	3	8	16	1	1.2	1.5	2.5	10	10	10	10	10	
20	0.8	1.2	1.5	1.5	3	8	20	1	1.2	1.5	1.5	10	10	10	10	10	
25	0.7	1.2	1.5	1.5	3	7	25	0.8	1	1.5	2	10	10	10	10	10	
32	-	1.2	1	1.5	2	6	32	-	1	1.5	2	8	8	8	8	10	
40	-	-	1	1.5	2	5	40	-	-	1.2	1.5	7	7	7	7	10	
50	-	-	-	1.2	1.5	4	50	-	-	-	1.5	6	6	6	6	10	
63	-	-	-	-	1.5	3	63	-	-	-	-	6	6	6	6	10	

FAZ-C and NZM 1/2

Selectivity limiting current I_s [kA] for selectivity between FAZ-C and NZM (overload and short-circuit release unit NZM at max. value).

FAZ-C	NZM...1-A... $I_{cu} = 25 (50) \text{ kA}$						FAZ-C	NZM...2-A... $I_{cu} = 25 (50)(100)(150) \text{ kA}$									
	40	50	63	80	100	125		40	50	63	80	100	125	160	200	250	
0.5	15	15	15	15	15	15	0.5	15	15	15	15	15	15	15	15	15	
1	15	15	15	15	15	15	1	15	15	15	15	15	15	15	15	15	
2	2	15	15	15	15	15	2	3	15	15	15	15	15	15	15	15	
3	1.2	2	3	3	10	15	3	1.5	1.5	3	5	15	15	15	15	15	
4	1.2	2	3	3	8	15	4	1.2	1.5	3	4	15	15	15	15	15	
6	1.2	2	2.5	3	5	10	6	1.2	1.5	2.5	3	15	15	15	15	15	
10	1.2	1.5	2	2	4	10	10	1	1.5	2.5	3	10	10	10	10	10	
13	1	1.5	2	2	4	10	13	1	1.2	2	3	10	10	10	10	10	
16	1	1.2	1.5	2	3	8	16	1	1.2	1.5	2.5	10	10	10	10	10	
20	0.8	1.2	1.5	1.5	3	8	20	1	1.2	1.5	1.5	10	10	10	10	10	
25	0.7	1.2	1.5	1.5	3	7	25	0.8	1	1.5	2	10	10	10	10	10	
32	-	1.2	1	1.5	2	6	32	-	1	1.5	2	8	8	8	8	10	
40	-	-	1	1.5	2	5	40	-	-	1.2	1.5	7	7	7	7	10	
50	-	-	-	1.2	1.5	4	50	-	-	-	1.5	6	6	6	6	10	
63	-	-	-	-	1.5	3	63	-	-	-	-	6	6	6	6	10	

FAZ-D and NZM 1/2

Selectivity limiting current I_s [kA] for selectivity between FAZ-D and NZM (overload and short-circuit release unit NZM at max. value).

FAZ-D	NZM...1-A...						FAZ-D	NZM...2-A...									
	$I_{cu} = 25 (50) \text{ kA}$							$I_{cu} = 25 (50)(100)(150) \text{ kA}$									
	40	50	63	80	100	125		40	50	63	80	100	125	160	200	250	
0.5	9	15	15	15	15	15	0.5	9	15	15	15	15	15	15	15	15	
1	0.5	0.7	1.1	1.9	4.2	15	1	0.5	0.7	1.1	1.9	4.2	15	15	15	15	
1.5	0.3	0.6	0.8	1.1	1.6	2.6	1.5	0.3	0.6	0.8	1.1	1.6	2.6	5	15	15	
2	0.3	0.5	0.75	0.95	1.4	2.4	2	0.3	0.5	0.75	0.95	1.4	2.4	4.5	10	15	
2.5	0.3	0.5	0.75	0.95	1.3	2.3	2.5	0.3	0.5	0.75	0.95	1.3	2.3	4.2	9	15	
3	0.3	0.5	0.7	0.9	1.3	2.1	3	0.3	0.5	0.7	0.9	1.3	2.1	3.6	7	15	
3.5	0.3	0.5	0.7	0.9	1.3	2	3.5	0.3	0.5	0.7	0.9	1.3	2	3.3	5.6	10	
4	0.3	0.5	0.7	0.9	1.3	1.9	4	0.3	0.5	0.7	0.9	1.3	1.9	3	4.7	8	
5	0.3	0.5	0.7	0.9	1.3	1.9	5	0.3	0.5	0.7	0.9	1.3	1.9	3	4.4	7	
6	0.3	0.5	0.6	0.9	1.3	1.8	6	0.3	0.5	0.6	0.9	1.3	1.8	2.8	4	6	
8	0.3	0.3	0.6	0.75	1	1.3	8	0.3	0.3	0.6	0.75	1	1.3	1.8	2.7	4	
10	0.3	0.3	0.6	0.75	0.95	1.2	10	0.3	0.3	0.6	0.75	0.95	1.2	1.7	2.4	3.6	
13	0.3	0.3	0.5	0.7	0.9	1.1	13	0.3	0.3	0.5	0.7	0.9	1.1	1.6	2.2	3.2	
16	-	0.3	0.5	0.65	0.8	1.1	16	-	0.3	0.5	0.65	0.8	1.1	1.5	2.1	3	
20	-	-	0.5	0.65	0.8	1.1	20	-	-	0.5	0.65	0.8	1.1	1.4	2.1	3	
25	-	-	0.5	0.65	0.8	1.1	25	-	-	0.5	0.65	0.8	1.1	1.4	1.9	2.7	
32	-	-	-	-	0.8	1.1	32	-	-	-	-	0.8	1.1	1.4	1.9	2.7	
40	-	-	-	-	-	1	40	-	-	-	-	-	1	1.4	1.8	2.6	

Back-up Protection FAZ

The up-stream protective devices will protect the down-stream FAZ up to the short-circuit current specified.

FAZ/C and AZ/C

FAZ/C	AZ/C								
I_n [A]	20	25	32	40	50	63	80	100	125
1	25	25	25	25	25	25	20	20	15 kA
2	25	25	25	25	25	25	20	20	15 kA
4	25	25	25	25	25	25	20	20	15 kA
6	25	25	25	25	25	25	20	20	15 kA
10	25	25	25	25	25	25	20	20	15 kA
13	25	25	25	25	25	25	20	20	15 kA
16	25	25	25	25	25	25	20	20	15 kA
20	1)	25	25	25	25	25	20	20	15 kA
25	1)	1)	25	25	25	25	20	20	15 kA
32	1)	1)	1)	25	25	25	20	20	-
40	1)	1)	1)	1)	25	25	20	20	-
50	1)	1)	1)	1)	1)	25	20	20	-
63	1)	1)	1)	1)	1)	1)	-	-	-

1) I_n (AZ) \leq I_n (FAZ)

FAZ and CL-PKZ0

Back-up tests acc. to EN/IEC 60947-2, App. A: $U = 1.05 U_e$, (O - t - CO)

FAZ B, C	CL-PKZ0
I_n [A]	$U_e = 230/400$ V
0.16	65 kA
0.25	65 kA
0.5	65 kA
0.75	65 kA
1	65 kA
1.5	65 kA
2	65 kA
2.5	65 kA
3	65 kA
3.5	65 kA
4	65 kA
5	45 kA
6	45 kA
8	45 kA
10	45 kA
12	45 kA
13	45 kA
15	45 kA
16	45 kA
20	45 kA
25	45 kA
32	45 kA
40	45 kA
50	45 kA
63	45 kA

FAZ and NZM7

FAZ B, C	NZM7-40(...100)
I_n [A]	$U_e = 230/400$ V
0.16	25 kA
0.25	25 kA
0.5	25 kA
0.75	25 kA
1	25 kA
1.5	25 kA
2	25 kA
2.5	25 kA
3	25 kA
3.5	25 kA
4	25 kA
5	20 kA
6	20 kA
8	20 kA
10	20 kA
12	20 kA
13	20 kA
15	20 kA
16	20 kA
20	18 kA
25	18 kA
32	18 kA
40	18 kA
50	15 kA
63	15 kA

FAZ and NZMB1

$U_e = 230/400\text{ V}$: I_{cu} (FAZ) = 15 kA
 $U_e = 230/400\text{ V}$: I_{cu} (NZMB1) = 25 kA
 Back-up test acc. to EN/IEC 60947-2, app. A: $U = 1.05U_e$, (O - t - W)
 (Settings NZMB1: I_r , I_m at max. volumes)

FAZ B, C	NZMB1
I_n [A]	$U_e = 230/400\text{ V}$
0.16	25 kA
0.25	25 kA
0.5	25 kA
0.75	25 kA
1	25 kA
1.5	25 kA
2	25 kA
2.5	25 kA
3	25 kA
3.5	25 kA
4	25 kA
5	25 kA
6	25 kA
8	25 kA
10	25 kA
12	25 kA
13	25 kA
15	25 kA
16	25 kA
20	20 kA
25	20 kA
32	20 kA
40	20 kA
50	15 kA
63	15 kA

FAZ and NZMN1

$U_e = 230/400\text{ V}$: I_{cu} (FAZ) = 15 kA
 $U_e = 230/400\text{ V}$: I_{cu} (NZMN1) = 25 kA
 Back-up test acc. to EN/IEC 60947-2, app. A: $U = 1.05U_e$, (O - t - W)
 (Settings NZM at max. volumes)

FAZ B, C	NZMN1
I_n [A]	$U_e = 230/400\text{ V}$
0.16	25 kA
0.25	25 kA
0.5	25 kA
0.75	25 kA
1	25 kA
1.5	25 kA
2	25 kA
2.5	25 kA
3	25 kA
3.5	25 kA
4	25 kA
5	25 kA
6	25 kA
8	25 kA
10	25 kA
12	25 kA
13	25 kA
15	25 kA
16	25 kA
20	20 kA
25	20 kA
32	20 kA
40	20 kA
50	15 kA
63	15 kA

FAZ and NZMB2

$U_e = 230/400\text{ V}$: I_{cu} (FAZ) = 15 kA
 $U_e = 230/400\text{ V}$: I_{cu} (NZMB2) = 25 kA
 $U_e = 133/230\text{ V}$: I_{cu} (FAZ) = 20 kA
 $U_e = 133/230\text{ V}$: I_{cu} (NZMB2) = 30 kA
 Back-up test acc. to EN/IEC 60947-2, app. A: $U = 1.05U_e$, (O - t - W)
 (Settings NZM at max. volumes)

FAZ B, C	NZMB2	
	$U_e = 230/400\text{ V}$	$U_e = 133/230\text{ V}$
I_n [A]		
0.16	25 kA	30 kA
0.25	25 kA	30 kA
0.5	25 kA	30 kA
0.75	25 kA	30 kA
1	25 kA	30 kA
1.5	25 kA	30 kA
2	25 kA	30 kA
2.5	25 kA	30 kA
3	25 kA	30 kA
3.5	25 kA	30 kA
4	25 kA	30 kA
5	25 kA	25 kA
6	25 kA	25 kA
8	25 kA	25 kA
10	25 kA	25 kA
12	20 kA	25 kA
13	20 kA	25 kA
15	20 kA	25 kA
16	20 kA	25 kA
20	20 kA	25 kA
25	20 kA	25 kA
32	20 kA	25 kA
40	15 kA	20 kA
50	15 kA	20 kA
63	15 kA	20 kA

FAZ and NZMN2

$U_e = 230/400\text{ V}$: I_{cu} (FAZ) = 15 kA
 $U_e = 230/400\text{ V}$: I_{cu} (NZMN2) = 50 kA
 $U_e = 133/230\text{ V}$: I_{cu} (FAZ) = 20 kA
 $U_e = 133/230\text{ V}$: I_{cu} (NZMN2) = 85 kA
 Back-up test acc. to EN/IEC 60947-2, app. A: $U = 1.05U_e$, (O - t - W)
 (Settings NZM at max. volumes)

FAZ B, C	NZMN2	
	$U_e = 230/400\text{ V}$	$U_e = 133/230\text{ V}$
I_n [A]		
0.16	50 kA	85 kA
0.25	50 kA	85 kA
0.5	50 kA	85 kA
0.75	50 kA	85 kA
1	50 kA	85 kA
1.5	50 kA	85 kA
2	50 kA	85 kA
2.5	50 kA	85 kA
3	50 kA	85 kA
3.5	50 kA	85 kA
4	50 kA	85 kA
5	50 kA	80 kA
6	50 kA	80 kA
8	50 kA	80 kA
10	50 kA	80 kA
12	30 kA	60 kA
13	30 kA	60 kA
15	30 kA	60 kA
16	30 kA	60 kA
20	30 kA	60 kA
25	30 kA	60 kA
32	30 kA	60 kA
40	20 kA	40 kA
50	20 kA	40 kA
63	20 kA	40 kA

FAZ and NZMH2

$U_e = 230/400\text{ V}$: I_{cu} (FAZ) = 15 kA
 $U_e = 230/400\text{ V}$: I_{cu} (NZMH2) = 150 kA
 $U_e = 133/230\text{ V}$: I_{cu} (FAZ) = 20 kA
 $U_e = 133/230\text{ V}$: I_{cu} (NZMH2) = 150 kA
 Back-up test acc. to EN/IEC 60947-2, app. A: $U = 1.05U_e$, (O - t - W)
 (Settings NZM at max. volumes)

FAZ B, C I_n [A]	NZMH2	
	$U_e = 230/400\text{ V}$	$U_e = 133/230\text{ V}$
0.16	50 kA	85 kA
0.25	50 kA	85 kA
0.5	50 kA	85 kA
0.75	50 kA	85 kA
1	50 kA	85 kA
1.5	50 kA	85 kA
2	50 kA	85 kA
2.5	50 kA	85 kA
3	50 kA	85 kA
3.5	50 kA	85 kA
4	50 kA	85 kA
5	50 kA	80 kA
6	50 kA	80 kA
8	50 kA	80 kA
10	50 kA	80 kA
12	30 kA	60 kA
13	30 kA	60 kA
15	30 kA	60 kA
16	30 kA	60 kA
20	30 kA	60 kA
25	30 kA	60 kA
32	30 kA	60 kA
40	20 kA	40 kA
50	20 kA	40 kA
63	20 kA	40 kA

FAZ and NZML2

$U_e = 230/400\text{ V}$: I_{cu} (FAZ) = 15 kA
 $U_e = 230/400\text{ V}$: I_{cu} (NZML2) = 150 kA
 $U_e = 133/230\text{ V}$: I_{cu} (FAZ) = 20 kA
 $U_e = 133/230\text{ V}$: I_{cu} (NZML2) = 150 kA
 Back-up test acc. to EN/IEC 60947-2, app. A: $U = 1.05U_e$, (O - t - W)
 (Settings NZM at max. volumes)

FAZ B, C I_n [A]	NZML2	
	$U_e = 230/400\text{ V}$	$U_e = 133/230\text{ V}$
0.16	50 kA	85 kA
0.25	50 kA	85 kA
0.5	50 kA	85 kA
0.75	50 kA	85 kA
1	50 kA	85 kA
1.5	50 kA	85 kA
2	50 kA	85 kA
2.5	50 kA	85 kA
3	50 kA	85 kA
3.5	50 kA	85 kA
4	50 kA	85 kA
5	50 kA	80 kA
6	50 kA	80 kA
8	50 kA	80 kA
10	50 kA	80 kA
12	30 kA	60 kA
13	30 kA	60 kA
15	30 kA	60 kA
16	30 kA	60 kA
20	30 kA	60 kA
25	30 kA	60 kA
32	30 kA	60 kA
40	20 kA	40 kA
50	20 kA	40 kA
63	20 kA	40 kA

FAZ and NH

$U_e = 230\text{ V}$: I_{cu} (FAZ) = 15 (10) kA (acc. to IEC/EN 60947)

$U_e = 500\text{ V}$: I_{cu} (NH00 125 A gL / gG) = 120kA

FAZ B, C, D	NH00 125 A gL/gG
I_n [A]	IT-system U = 230 V
0.5	50 kA
1	50 kA
2	50 kA
3	50 kA
4	50 kA
6	50 kA
10	50 kA
13	50 kA
16	50 kA
20	50 kA
25	50 kA
32	50 kA
40	50 kA
50	50 kA
63	50 kA

Overload Selectivity FAZ

FAZ-B(C)(D) to FAZ-B

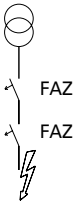

Upstream side FAZ, Characteristic B
Downstream side FAZ, Characteristic B, C, D

x ... Selectivity range (i.e. only the downstream switch drops in case $I < I_s$)

Type B Rated current I_n [A] Selectivity limiting current I_s [A]	Upstream side —> FAZ Characteristic B												
	2	3	4	6	10	13	16	20	25	32	40	50	63
2		x	x	x	x	x	x	x	x	x	x	x	x
3			x	x	x	x	x	x	x	x	x	x	x
4				x	x	x	x	x	x	x	x	x	x
6					x	x	x	x	x	x	x	x	x
10						x	x	x	x	x	x	x	x
13							x	x	x	x	x	x	x
16								x	x	x	x	x	x
20									x	x	x	x	x
25										x	x	x	x
32											x	x	x
40												x	x
50													x
63													

Type B Rated current I_n [A] Selectivity limiting current I_s [A]	Upstream side —> FAZ Characteristic B												
	2	3	4	6	10	13	16	20	25	32	40	50	63
0.5	x	x	x	x	x	x	x	x	x	x	x	x	x
1	x	x	x	x	x	x	x	x	x	x	x	x	x
2			x	x	x	x	x	x	x	x	x	x	x
3				x	x	x	x	x	x	x	x	x	x
4					x	x	x	x	x	x	x	x	x
6						x	x	x	x	x	x	x	x
8							x	x	x	x	x	x	x
10								x	x	x	x	x	x
13									x	x	x	x	x
16										x	x	x	x
20											x	x	x
25												x	x
32													x
40													
50													
63													

Type B Rated current I_n [A] Selectivity limiting current I_s [A]	Upstream side —> FAZ Characteristic B												
	2	3	4	6	10	13	16	20	25	32	40	50	63
2					x	x	x	x	x	x	x	x	x
4							x	x	x	x	x	x	x
6								x	x	x	x	x	x
10									x	x	x	x	x
13										x	x	x	x
16											x	x	x
20												x	x
25													
32													
40													

FAZ-B(C)(D) to FAZ-C

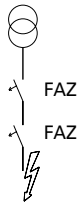

Upstream side FAZ, Characteristic C
Downstream side FAZ, Characteristic B, C, D

x ... Selectivity range (i.e. only the downstream switch drops in case $I < I_s$)

Type B Rated current I_n [A]	Upstream side → FAZ Characteristic C															
	0.5	1	2	3	4	6	8	10	13	16	20	25	32	40	50	63
Selectivity limiting current I_s [A]	2.85	5.7	11.4	17.1	22.8	34.2	45.6	57	74.1	91.2	114	142.5	182.4	228	285	359.1
Downstream side FAZ Characteristic B	2			x	x	x	x	x	x	x	x	x	x	x	x	x
	3				x	x	x	x	x	x	x	x	x	x	x	x
	4					x	x	x	x	x	x	x	x	x	x	x
	6						x	x	x	x	x	x	x	x	x	x
	10								x	x	x	x	x	x	x	x
	13									x	x	x	x	x	x	x
	16										x	x	x	x	x	x
	20											x	x	x	x	x
	25												x	x	x	x
	32													x	x	x
	40														x	x
	50															x
	63															

Type B Rated current I_n [A]	Upstream side → FAZ Characteristic C															
	0.5	1	2	3	4	6	8	10	13	16	20	25	32	40	50	63
Selectivity limiting current I_s [A]	2.85	5.7	11.4	17.1	22.8	34.2	45.6	57	74.1	91.2	114	142.5	182.4	228	285	359.1
Downstream side FAZ Characteristic C	0.5	x	x	x	x	x	x	x	x	x	x	x	x	x	x	x
	1		x	x	x	x	x	x	x	x	x	x	x	x	x	x
	2			x	x	x	x	x	x	x	x	x	x	x	x	x
	3				x	x	x	x	x	x	x	x	x	x	x	x
	4					x	x	x	x	x	x	x	x	x	x	x
	6						x	x	x	x	x	x	x	x	x	x
	8							x	x	x	x	x	x	x	x	x
	10								x	x	x	x	x	x	x	x
	13									x	x	x	x	x	x	x
	16										x	x	x	x	x	x
	20											x	x	x	x	x
	25												x	x	x	x
	32													x	x	x
40														x	x	
50															x	
63																

Type B Rated current I_n [A]	Upstream side → FAZ Characteristic C															
	0.5	1	2	3	4	6	8	10	13	16	20	25	32	40	50	63
Selectivity limiting current I_s [A]	2.85	5.7	11.4	17.1	22.8	34.2	45.6	57	74.1	91.2	114	142.5	182.4	228	285	359.1
Downstream side FAZ Characteristic D	2					x	x	x	x	x	x	x	x	x	x	x
	4						x	x	x	x	x	x	x	x	x	x
	6								x	x	x	x	x	x	x	x
	10										x	x	x	x	x	x
	13											x	x	x	x	x
	16												x	x	x	x
	20													x	x	x
	25														x	x
	32															
	40															

FAZ-B(C)(D) to FAZ-D

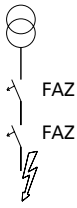

Upstream side FAZ, Characteristic D
Downstream side FAZ, Characteristic B, C, D

x ...Selectivity range (i.e. only the downstream switch drops in case $I < I_s$)

Type B Rated current I_n [A] Selectivity limiting current I_s [A]	Upstream side → FAZ Characteristic D									
	2	4	6	10	13	16	20	25	32	40
	21	42	63	105	136.5	168	210	262.5	336	420
Downstream side FAZ Characteristic B	2	x	x	x	x	x	x	x	x	x
	3		x	x	x	x	x	x	x	x
	4			x	x	x	x	x	x	x
	6				x	x	x	x	x	x
	10					x	x	x	x	x
	13						x	x	x	x
	16							x	x	x
	20								x	x
	25									x
	32									x
	40									
	50									
	63									

Type B Rated current I_n [A] Selectivity limiting current I_s [A]	Upstream side → FAZ Characteristic D									
	2	4	6	10	13	16	20	25	32	40
	21	42	63	105	136.5	168	210	262.5	336	420
Downstream side FAZ Characteristic C	0.5	x	x	x	x	x	x	x	x	x
	1	x	x	x	x	x	x	x	x	x
	2		x	x	x	x	x	x	x	x
	3			x	x	x	x	x	x	x
	4				x	x	x	x	x	x
	6					x	x	x	x	x
	8						x	x	x	x
	10							x	x	x
	13								x	x
	16									x
	20									
	25									
	32									
	40									
	50									
63										

Type B Rated current I_n [A] Selectivity limiting current I_s [A]	Upstream side → FAZ Characteristic D									
	2	4	6	10	13	16	20	25	32	40
	21	42	63	105	136.5	168	210	262.5	336	420
Downstream side FAZ Characteristic D	2	x	x	x	x	x	x	x	x	x
	4			x	x	x	x	x	x	x
	6				x	x	x	x	x	x
	10					x	x	x	x	x
	13						x	x	x	x
	16							x	x	x
	20								x	x
	25									x
	32									
	40									

FAZ-B(C)(D) to AZ-C

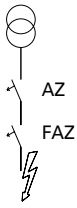

Upstream side AZ, Characteristic C
Downstream side FAZ, Characteristic B, C, D

x ... Selectivity range (i.e. only the downstream switch drops in case $I < I_s$)

Type B Rated current I_n [A] Selectivity limiting current I_s [A]	Upstream side → AZ Characteristic C								
	20	25	32	40	50	63	80	100	125
	130	163	208	260	325	410	520	650	813
Downstream side FAZ Characteristic B	2	x	x	x	x	x	x	x	x
	3	x	x	x	x	x	x	x	x
	4	x	x	x	x	x	x	x	x
	6	x	x	x	x	x	x	x	x
	10	x	x	x	x	x	x	x	x
	13	x	x	x	x	x	x	x	x
	16	x	x	x	x	x	x	x	x
	20		x	x	x	x	x	x	x
	25			x	x	x	x	x	x
	32				x	x	x	x	x
	40					x	x	x	x
	50						x	x	x
	63							x	x

Type B Rated current I_n [A] Selectivity limiting current I_s [A]	Upstream side → AZ Characteristic C								
	20	25	32	40	50	63	80	100	125
	130	163	208	260	325	410	520	650	813
Downstream side FAZ Characteristic C	0.5	x	x	x	x	x	x	x	x
	1	x	x	x	x	x	x	x	x
	2	x	x	x	x	x	x	x	x
	3	x	x	x	x	x	x	x	x
	4	x	x	x	x	x	x	x	x
	6	x	x	x	x	x	x	x	x
	8	x	x	x	x	x	x	x	x
	10	x	x	x	x	x	x	x	x
	13	x	x	x	x	x	x	x	x
	16	x	x	x	x	x	x	x	x
	20		x	x	x	x	x	x	x
	25			x	x	x	x	x	x
	32				x	x	x	x	x
40					x	x	x	x	
50						x	x	x	
63							x	x	

Type B Rated current I_n [A] Selectivity limiting current I_s [A]	Upstream side → AZ Characteristic C								
	20	25	32	40	50	63	80	100	125
	130	163	208	260	325	410	520	650	813
Downstream side FAZ Characteristic D	2	x	x	x	x	x	x	x	x
	4	x	x	x	x	x	x	x	x
	6	x	x	x	x	x	x	x	x
	10	x	x	x	x	x	x	x	x
	13		x	x	x	x	x	x	x
	16			x	x	x	x	x	x
	20				x	x	x	x	x
	25					x	x	x	x
	32						x	x	x
	40							x	x

FAZ-B(C)(D) to AZ-D

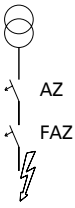

Upstream side AZ, Characteristic D
Downstream side FAZ, Characteristic B, C, D

x ... Selectivity range (i.e. only the downstream switch drops in case $I < I_s$)

Type B Rated current I_n [A] Selectivity limiting current I_s [A]	Upstream side → AZ Characteristic D							
	20	25	32	40	50	63	80	100
	230	285	365	450	550	680	850	1020
Downstream side FAZ Characteristic B	2	x	x	x	x	x	x	x
	3	x	x	x	x	x	x	x
	4	x	x	x	x	x	x	x
	6	x	x	x	x	x	x	x
	10	x	x	x	x	x	x	x
	13	x	x	x	x	x	x	x
	16	x	x	x	x	x	x	x
	20		x	x	x	x	x	x
	25			x	x	x	x	x
	32				x	x	x	x
	40					x	x	x
	50						x	x
	63							x

Type B Rated current I_n [A] Selectivity limiting current I_s [A]	Upstream side → AZ Characteristic D							
	20	25	32	40	50	63	80	100
	230	285	365	450	550	680	850	1020
Downstream side FAZ Characteristic C	0.5	x	x	x	x	x	x	x
	1	x	x	x	x	x	x	x
	2	x	x	x	x	x	x	x
	3	x	x	x	x	x	x	x
	4	x	x	x	x	x	x	x
	6	x	x	x	x	x	x	x
	8	x	x	x	x	x	x	x
	10	x	x	x	x	x	x	x
	13	x	x	x	x	x	x	x
	16	x	x	x	x	x	x	x
	20		x	x	x	x	x	x
	25			x	x	x	x	x
	32				x	x	x	x
	40					x	x	x
50						x	x	
63							x	

Type B Rated current I_n [A] Selectivity limiting current I_s [A]	Upstream side → AZ Characteristic D							
	20	25	32	40	50	63	80	100
	230	285	365	450	550	680	850	1020
Downstream side FAZ Characteristic D	2	x	x	x	x	x	x	x
	4	x	x	x	x	x	x	x
	6	x	x	x	x	x	x	x
	10	x	x	x	x	x	x	x
	13	x	x	x	x	x	x	x
	16	x	x	x	x	x	x	x
	20		x	x	x	x	x	x
	25			x	x	x	x	x
	32				x	x	x	x
40					x	x	x	

Influence of the Line Frequency FAZ

On the Instantaneous Tripping Current I_{MA}

	Line Frequency f [Hz]						
	16²/₃	50	60	100	200	300	400
$I_{MA}(f)/I_{MA}(50\text{ Hz})$ [%]	91	100	101	106	115	134	141

The use of the products in networks with other frequencies than 50/60 Hz are in the customer's responsibility.

SG56012



Description

FAZ-T

- High-quality miniature circuit breakers for industrial and commercial applications
- Contact position indicator red - green
- Accessories suitable for subsequent installation
- Rated currents up to 40 A
- Tripping characteristics B, C, D
- Rated breaking capacity up to 25 kA according to EN 60947-2
- Classified for the use in rail rolling stock

Rated current I_n (A)	Rated voltage acc. to IEC/EN 60898-1 (V)	Breaking capacity acc. to IEC/EN 60898-1 (kA)	Rated voltage acc. to IEC/EN 60947-2 (V)	Breaking capacity acc. to IEC/EN 60947-2 (kA)	Rated voltage acc. to IEC/EN 60947-2 (V)	Breaking capacity acc. to IEC/EN 60947-2 (kA)	Type Designation	Article No.	Units per package
----------------------------	--	--	--	--	--	--	---------------------	-------------	----------------------

Characteristic B

SG53212



1-pole

1	240	15	240	25	254	15	FAZT-B1/1	240770	12/120
2	240	15	240	25	254	15	FAZT-B2/1	240771	12/120
3	240	15	240	25	254	15	FAZT-B3/1	240772	12/120
4	240	15	240	25	254	15	FAZT-B4/1	240777	12/120
6	240	15	240	25	254	15	FAZT-B6/1	240782	12/120
10	240	15	240	25	254	15	FAZT-B10/1	240787	12/120
12	240	15	240	25	254	15	FAZT-B12/1	240792	12/120
13	240	15	240	25	254	15	FAZT-B13/1	240793	12/120
15	240	15	240	25	254	15	FAZT-B15/1	240794	12/120
16	240	15	240	25	254	15	FAZT-B16/1	240795	12/120
20	240	15	240	25	254	15	FAZT-B20/1	240796	12/120
25	240	15	240	25	254	15	FAZT-B25/1	240797	12/120
32	240	10	240	20	254	15	FAZT-B32/1	141907	12/120
40	240	10	240	20	254	15	FAZT-B40/1	141908	12/120

SG5412



1+N-poles

1	240	15	240	25	254	15	FAZT-B1/1N	240994	1/60
2	240	15	240	25	254	15	FAZT-B2/1N	240995	1/60
3	240	15	240	25	254	15	FAZT-B3/1N	240996	1/60
4	240	15	240	25	254	15	FAZT-B4/1N	240997	1/60
6	240	15	240	25	254	15	FAZT-B6/1N	240998	1/60
10	240	15	240	25	254	15	FAZT-B10/1N	240999	1/60
12	240	15	240	25	254	15	FAZT-B12/1N	241000	1/60
13	240	15	240	25	254	15	FAZT-B13/1N	241001	1/60
15	240	15	240	25	254	15	FAZT-B15/1N	241005	1/60
16	240	15	240	25	254	15	FAZT-B16/1N	241009	1/60
20	240	15	240	25	254	15	FAZT-B20/1N	241015	1/60
25	240	15	240	25	254	15	FAZT-B25/1N	241019	1/60
32	240	10	240	20	254	15	FAZT-B32/1N	142509	1/60
40	240	10	240	20	254	15	FAZT-B40/1N	142510	1/60

SG55212



2-poles

1	415	15	240/415	25	254/440	15	FAZT-B1/2	240820	1/60
2	415	15	240/415	25	254/440	15	FAZT-B2/2	240821	1/60
3	415	15	240/415	25	254/440	15	FAZT-B3/2	240822	1/60
4	415	15	240/415	25	254/440	15	FAZT-B4/2	240823	1/60
6	415	15	240/415	25	254/440	15	FAZT-B6/2	240824	1/60
10	415	15	240/415	25	254/440	15	FAZT-B10/2	240825	1/60
12	415	15	240/415	25	254/440	15	FAZT-B12/2	240826	1/60
13	415	15	240/415	25	254/440	15	FAZT-B13/2	240827	1/60
15	415	15	240/415	25	254/440	15	FAZT-B15/2	240828	1/60
16	415	15	240/415	25	254/440	15	FAZT-B16/2	240829	1/60
20	415	15	240/415	25	254/440	15	FAZT-B20/2	240830	1/60
25	415	15	240/415	25	254/440	15	FAZT-B25/2	240831	1/60
32	415	10	240/415	20	254/440	15	FAZT-B32/2	142485	1/60
40	415	10	240/415	20	254/440	15	FAZT-B40/2	142486	1/60

Rated current I_n (A)	Rated voltage acc. to IEC/EN 60898-1 (V)	Breaking capacity acc. to IEC/EN 60898-1 (kA)	Rated voltage acc. to IEC/EN 60947-2 (V)	Breaking capacity acc. to IEC/EN 60947-2 (kA)	Rated voltage acc. to IEC/EN 60947-2 (V)	Breaking capacity acc. to IEC/EN 60947-2 (kA)	Type Designation	Article No.	Units per package
----------------------------	--	--	--	--	--	--	---------------------	-------------	----------------------

SG53512



3-poles

1	415	15	240/415	25	254/440	15	FAZT-B1/3	240874	1/40
2	415	15	240/415	25	254/440	15	FAZT-B2/3	240875	1/40
3	415	15	240/415	25	254/440	15	FAZT-B3/3	240876	1/40
4	415	15	240/415	25	254/440	15	FAZT-B4/3	240877	1/40
6	415	15	240/415	25	254/440	15	FAZT-B6/3	240878	1/40
10	415	15	240/415	25	254/440	15	FAZT-B10/3	240879	1/40
12	415	15	240/415	25	254/440	15	FAZT-B12/3	240880	1/40
13	415	15	240/415	25	254/440	15	FAZT-B13/3	240881	1/40
15	415	15	240/415	25	254/440	15	FAZT-B15/3	240882	1/40
16	415	15	240/415	25	254/440	15	FAZT-B16/3	240883	1/40
20	415	15	240/415	25	254/440	15	FAZT-B20/3	240884	1/40
25	415	15	240/415	25	254/440	15	FAZT-B25/3	240885	1/40
32	415	10	240/415	20	254/440	15	FAZT-B32/3	142493	1/40
40	415	10	240/415	20	254/440	15	FAZT-B40/3	142494	1/40

SG55912



3+N-poles

1	415	15	240/415	25	254/440	15	FAZT-B1/3N	241060	1/30
2	415	15	240/415	25	254/440	15	FAZT-B2/3N	241065	1/30
3	415	15	240/415	25	254/440	15	FAZT-B3/3N	241070	1/30
4	415	15	240/415	25	254/440	15	FAZT-B4/3N	241075	1/30
6	415	15	240/415	25	254/440	15	FAZT-B6/3N	241080	1/30
10	415	15	240/415	25	254/440	15	FAZT-B10/3N	241085	1/30
12	415	15	240/415	25	254/440	15	FAZT-B12/3N	241090	1/30
13	415	15	240/415	25	254/440	15	FAZT-B13/3N	241095	1/30
15	415	15	240/415	25	254/440	15	FAZT-B15/3N	241100	1/30
16	415	15	240/415	25	254/440	15	FAZT-B16/3N	241105	1/30
20	415	15	240/415	25	254/440	15	FAZT-B20/3N	241110	1/30
25	415	15	240/415	25	254/440	15	FAZT-B25/3N	241115	1/30
32	415	10	240/415	20	254/440	15	FAZT-B32/3N	142517	1/30
40	415	10	240/415	20	254/440	15	FAZT-B40/3N	142518	1/30

SG56012



4-poles

1	415	15	240/415	25	254/440	15	FAZT-B1/4	240922	1/30
2	415	15	240/415	25	254/440	15	FAZT-B2/4	240927	1/30
3	415	15	240/415	25	254/440	15	FAZT-B3/4	240930	1/30
4	415	15	240/415	25	254/440	15	FAZT-B4/4	240931	1/30
6	415	15	240/415	25	254/440	15	FAZT-B6/4	240932	1/30
10	415	15	240/415	25	254/440	15	FAZT-B10/4	240933	1/30
12	415	15	240/415	25	254/440	15	FAZT-B12/4	240934	1/30
13	415	15	240/415	25	254/440	15	FAZT-B13/4	240935	1/30
15	415	15	240/415	25	254/440	15	FAZT-B15/4	240936	1/30
16	415	15	240/415	25	254/440	15	FAZT-B16/4	240937	1/30
20	415	15	240/415	25	254/440	15	FAZT-B20/4	240938	1/30
25	415	15	240/415	25	254/440	15	FAZT-B25/4	240939	1/30
32	415	10	240/415	20	254/440	15	FAZT-B32/4	142501	1/30
40	415	10	240/415	20	254/440	15	FAZT-B40/4	142502	1/30

Rated current I_n (A)	Rated voltage acc. to IEC/EN 60898-1 (V)	Breaking capacity acc. to IEC/EN 60898-1 (kA)	Rated voltage acc. to IEC/EN 60947-2 (V)	Breaking capacity acc. to IEC/EN 60947-2 (kA)	Rated voltage acc. to IEC/EN 60947-2 (V)	Breaking capacity acc. to IEC/EN 60947-2 (kA)	Type Designation	Article No.	Units per package
----------------------------	--	--	--	--	--	--	---------------------	-------------	----------------------

Characteristic C

SG53212



1-pole

1	240	15	240	25	254	15	FAZT-C1/1	240798	12/120
2	240	15	240	25	254	15	FAZT-C2/1	240799	12/120
3	240	15	240	25	254	15	FAZT-C3/1	240800	12/120
4	240	15	240	25	254	15	FAZT-C4/1	240801	12/120
6	240	15	240	25	254	15	FAZT-C6/1	240802	12/120
10	240	15	240	25	254	15	FAZT-C10/1	240803	12/120
12	240	15	240	25	254	15	FAZT-C12/1	240804	12/120
13	240	15	240	25	254	15	FAZT-C13/1	240805	12/120
15	240	15	240	25	254	15	FAZT-C15/1	240806	12/120
16	240	15	240	25	254	15	FAZT-C16/1	240807	12/120
20	240	15	240	25	254	15	FAZT-C20/1	240808	12/120
25	240	15	240	25	254	15	FAZT-C25/1	240809	12/120
32	240	10	240	20	254	15	FAZT-C32/1	141909	12/120
40	240	10	240	20	254	15	FAZT-C40/1	142480	12/120

SG5412



1+N-poles

1	240	15	240	25	254	15	FAZT-C1/1N	241022	1/60
2	240	15	240	25	254	15	FAZT-C2/1N	241023	1/60
3	240	15	240	25	254	15	FAZT-C3/1N	241024	1/60
4	240	15	240	25	254	15	FAZT-C4/1N	241025	1/60
6	240	15	240	25	254	15	FAZT-C6/1N	241026	1/60
10	240	15	240	25	254	15	FAZT-C10/1N	241027	1/60
12	240	15	240	25	254	15	FAZT-C12/1N	241028	1/60
13	240	15	240	25	254	15	FAZT-C13/1N	241029	1/60
15	240	15	240	25	254	15	FAZT-C15/1N	241030	1/60
16	240	15	240	25	254	15	FAZT-C16/1N	241034	1/60
20	240	15	240	25	254	15	FAZT-C20/1N	241038	1/60
25	240	15	240	25	254	15	FAZT-C25/1N	241044	1/60
32	240	10	240	20	254	15	FAZT-C32/1N	142511	1/60
40	240	10	240	20	254	15	FAZT-C40/1N	142512	1/60

SG55212



2-poles

1	415	15	240/415	25	254/440	15	FAZT-C1/2	240832	1/60
2	415	15	240/415	25	254/440	15	FAZT-C2/2	240833	1/60
3	415	15	240/415	25	254/440	15	FAZT-C3/2	240838	1/60
4	415	15	240/415	25	254/440	15	FAZT-C4/2	240843	1/60
6	415	15	240/415	25	254/440	15	FAZT-C6/2	240850	1/60
10	415	15	240/415	25	254/440	15	FAZT-C10/2	240855	1/60
12	415	15	240/415	25	254/440	15	FAZT-C12/2	240858	1/60
13	415	15	240/415	25	254/440	15	FAZT-C13/2	240859	1/60
15	415	15	240/415	25	254/440	15	FAZT-C15/2	240860	1/60
16	415	15	240/415	25	254/440	15	FAZT-C16/2	240861	1/60
20	415	15	240/415	25	254/440	15	FAZT-C20/2	240862	1/60
25	415	15	240/415	25	254/440	15	FAZT-C25/2	240863	1/60
32	415	10	240/415	20	254/440	15	FAZT-C32/2	142487	1/60
40	415	10	240/415	20	254/440	15	FAZT-C40/2	142488	1/60

Rated current I_n (A)	Rated voltage acc. to IEC/EN 60898-1 (V)	Breaking capacity acc. to IEC/EN 60898-1 (kA)	Rated voltage acc. to IEC/EN 60947-2 (V)	Breaking capacity acc. to IEC/EN 60947-2 (kA)	Rated voltage acc. to IEC/EN 60947-2 (V)	Breaking capacity acc. to IEC/EN 60947-2 (kA)	Type Designation	Article No.	Units per package
----------------------------	--	--	--	--	--	--	---------------------	-------------	----------------------

SG53512



3-poles

1	415	15	240/415	25	254/440	15	FAZT-C1/3	240886	1/40
2	415	15	240/415	25	254/440	15	FAZT-C2/3	240887	1/40
3	415	15	240/415	25	254/440	15	FAZT-C3/3	240888	1/40
4	415	15	240/415	25	254/440	15	FAZT-C4/3	240889	1/40
6	415	15	240/415	25	254/440	15	FAZT-C6/3	240890	1/40
10	415	15	240/415	25	254/440	15	FAZT-C10/3	240891	1/40
12	415	15	240/415	25	254/440	15	FAZT-C12/3	240892	1/40
13	415	15	240/415	25	254/440	15	FAZT-C13/3	240893	1/40
15	415	15	240/415	25	254/440	15	FAZT-C15/3	240894	1/40
16	415	15	240/415	25	254/440	15	FAZT-C16/3	240895	1/40
20	415	15	240/415	25	254/440	15	FAZT-C20/3	240896	1/40
25	415	15	240/415	25	254/440	15	FAZT-C25/3	240897	1/40
32	415	10	240/415	20	254/440	15	FAZT-C32/3	142495	1/40
40	415	10	240/415	20	254/440	15	FAZT-C40/3	142496	1/40

SG55912



3+N-poles

1	415	15	240/415	25	254/440	15	FAZT-C1/3N	241120	1/30
2	415	15	240/415	25	254/440	15	FAZT-C2/3N	241125	1/30
3	415	15	240/415	25	254/440	15	FAZT-C3/3N	241130	1/30
4	415	15	240/415	25	254/440	15	FAZT-C4/3N	241135	1/30
6	415	15	240/415	25	254/440	15	FAZT-C6/3N	241140	1/30
10	415	15	240/415	25	254/440	15	FAZT-C10/3N	241145	1/30
12	415	15	240/415	25	254/440	15	FAZT-C12/3N	241150	1/30
13	415	15	240/415	25	254/440	15	FAZT-C13/3N	241155	1/30
15	415	15	240/415	25	254/440	15	FAZT-C15/3N	241160	1/30
16	415	15	240/415	25	254/440	15	FAZT-C16/3N	241165	1/30
20	415	15	240/415	25	254/440	15	FAZT-C20/3N	241170	1/30
25	415	15	240/415	25	254/440	15	FAZT-C25/3N	241175	1/30
32	415	10	240/415	20	254/440	15	FAZT-C32/3N	142519	1/30
40	415	10	240/415	20	254/440	15	FAZT-C40/3N	142520	1/30

SG56012



4-poles

1	415	15	240/415	25	254/440	15	FAZT-C1/4	240940	1/30
2	415	15	240/415	25	254/440	15	FAZT-C2/4	240941	1/30
3	415	15	240/415	25	254/440	15	FAZT-C3/4	240945	1/30
4	415	15	240/415	25	254/440	15	FAZT-C4/4	240949	1/30
6	415	15	240/415	25	254/440	15	FAZT-C6/4	240955	1/30
10	415	15	240/415	25	254/440	15	FAZT-C10/4	240959	1/30
12	415	15	240/415	25	254/440	15	FAZT-C12/4	240962	1/30
13	415	15	240/415	25	254/440	15	FAZT-C13/4	240963	1/30
15	415	15	240/415	25	254/440	15	FAZT-C15/4	240964	1/30
16	415	15	240/415	25	254/440	15	FAZT-C16/4	240965	1/30
20	415	15	240/415	25	254/440	15	FAZT-C20/4	240966	1/30
25	415	15	240/415	25	254/440	15	FAZT-C25/4	240967	1/30
32	415	10	240/415	20	254/440	15	FAZT-C32/4	142503	1/30
40	415	10	240/415	20	254/440	15	FAZT-C40/4	142504	1/30

FAZ-T Miniature Circuit Breakers

Rated current I_n (A)	Rated voltage acc. to IEC/EN 60898-1 (V)	Breaking capacity acc. to IEC/EN 60898-1 (kA)	Rated voltage acc. to IEC/EN 60947-2 (V)	Breaking capacity acc. to IEC/EN 60947-2 (kA)	Type Designation	Article No.	Units per package
----------------------------	--	--	--	--	---------------------	-------------	----------------------

Characteristic D

SG53212



1-pole

1	240	15	240	25	FAZT-D1/1	240810	12/120
2	240	15	240	25	FAZT-D2/1	240811	12/120
3	240	15	240	25	FAZT-D3/1	240812	12/120
4	240	15	240	25	FAZT-D4/1	240813	12/120
6	240	15	240	25	FAZT-D6/1	240814	12/120
10	240	15	240	25	FAZT-D10/1	240815	12/120
12	240	15	240	25	FAZT-D12/1	240816	12/120
13	240	15	240	25	FAZT-D13/1	240817	12/120
15	240	15	240	20	FAZT-D15/1	240818	12/120
16	240	15	240	20	FAZT-D16/1	240819	12/120
20	240	10	240	20	FAZT-D20/1	142481	12/120
25	240	10	240	15	FAZT-D25/1	142482	12/120
32	240	10	240	15	FAZT-D32/1	142483	12/120
40	240	10	240	15	FAZT-D40/1	142484	12/120

SG5412



1+N-poles

1	240	15	240	25	FAZT-D1/1N	241048	1/60
2	240	15	240	25	FAZT-D2/1N	241051	1/60
3	240	15	240	25	FAZT-D3/1N	241052	1/60
4	240	15	240	25	FAZT-D4/1N	241053	1/60
6	240	15	240	25	FAZT-D6/1N	241054	1/60
10	240	15	240	25	FAZT-D10/1N	241055	1/60
12	240	15	240	25	FAZT-D12/1N	241056	1/60
13	240	15	240	25	FAZT-D13/1N	241057	1/60
15	240	15	240	20	FAZT-D15/1N	241058	1/60
16	240	15	240	20	FAZT-D16/1N	241059	1/60
20	240	10	240	20	FAZT-D20/1N	142513	1/60
25	240	10	240	15	FAZT-D25/1N	142514	1/60
32	240	10	240	15	FAZT-D32/1N	142515	1/60
40	240	10	240	15	FAZT-D40/1N	142516	1/60

SG55212



2-poles

1	415	15	240/415	25	FAZT-D1/2	240864	1/60
2	415	15	240/415	25	FAZT-D2/2	240865	1/60
3	415	15	240/415	25	FAZT-D3/2	240866	1/60
4	415	15	240/415	25	FAZT-D4/2	240867	1/60
6	415	15	240/415	25	FAZT-D6/2	240868	1/60
10	415	15	240/415	25	FAZT-D10/2	240869	1/60
12	415	15	240/415	25	FAZT-D12/2	240870	1/60
13	415	15	240/415	25	FAZT-D13/2	240871	1/60
15	415	15	240/415	20	FAZT-D15/2	240872	1/60
16	415	15	240/415	20	FAZT-D16/2	240873	1/60
20	415	10	240/415	20	FAZT-D20/2	142489	1/60
25	415	10	240/415	15	FAZT-D25/2	142490	1/60
32	415	10	240/415	15	FAZT-D32/2	142491	1/60
40	415	10	240/415	15	FAZT-D40/2	142492	1/60

Rated current I_n (A)	Rated voltage acc. to IEC/EN 60898-1 (V)	Breaking capacity acc. to IEC/EN 60898-1 (kA)	Rated voltage acc. to IEC/EN 60947-2 (V)	Breaking capacity acc. to IEC/EN 60947-2 (kA)	Type Designation	Article No.	Units per package
----------------------------	--	--	--	--	---------------------	-------------	----------------------

SG55612



3-poles

1	415	15	240/415	25	FAZT-D1/3	240898	1/40
2	415	15	240/415	25	FAZT-D2/3	240899	1/40
3	415	15	240/415	25	FAZT-D3/3	240900	1/40
4	415	15	240/415	25	FAZT-D4/3	240901	1/40
6	415	15	240/415	25	FAZT-D6/3	240902	1/40
10	415	15	240/415	25	FAZT-D10/3	240903	1/40
12	415	15	240/415	25	FAZT-D12/3	240904	1/40
13	415	15	240/415	25	FAZT-D13/3	240905	1/40
15	415	15	240/415	25	FAZT-D15/3	240910	1/40
16	415	15	240/415	25	FAZT-D16/3	240915	1/40
20	415	10	240/415	20	FAZT-D20/3	142497	1/40
25	415	10	240/415	15	FAZT-D25/3	142498	1/40
32	415	10	240/415	15	FAZT-D32/3	142499	1/40
40	415	10	240/415	15	FAZT-D40/3	142500	1/40

SG55912



3+N-poles

1	415	15	240/415	25	FAZT-D1/3N	241180	1/30
2	415	15	240/415	25	FAZT-D2/3N	241181	1/30
3	415	15	240/415	25	FAZT-D3/3N	241182	1/30
4	415	15	240/415	25	FAZT-D4/3N	241183	1/30
6	415	15	240/415	25	FAZT-D6/3N	241184	1/30
10	415	15	240/415	25	FAZT-D10/3N	241185	1/30
12	415	15	240/415	25	FAZT-D12/3N	241186	1/30
13	415	15	240/415	25	FAZT-D13/3N	241187	1/30
15	415	15	240/415	25	FAZT-D15/3N	241188	1/30
16	415	15	240/415	25	FAZT-D16/3N	241189	1/30
20	415	10	240/415	20	FAZT-D20/3N	142521	1/30
25	415	10	240/415	15	FAZT-D25/3N	142522	1/30
32	415	10	240/415	15	FAZT-D32/3N	142523	1/30
40	415	10	240/415	15	FAZT-D40/3N	142524	1/30

SG56012



4-poles

1	415	15	240/415	25	FAZT-D1/4	240968	1/30
2	415	15	240/415	25	FAZT-D2/4	240969	1/30
3	415	15	240/415	25	FAZT-D3/4	240970	1/30
4	415	15	240/415	25	FAZT-D4/4	240971	1/30
6	415	15	240/415	25	FAZT-D6/4	240975	1/30
10	415	15	240/415	25	FAZT-D10/4	240979	1/30
12	415	15	240/415	25	FAZT-D12/4	240985	1/30
13	415	15	240/415	25	FAZT-D13/4	240989	1/30
15	415	15	240/415	25	FAZT-D15/4	240992	1/30
16	415	15	240/415	25	FAZT-D16/4	240993	1/30
20	415	10	240/415	20	FAZT-D20/4	142505	1/30
25	415	10	240/415	15	FAZT-D25/4	142506	1/30
32	415	10	240/415	15	FAZT-D32/4	142507	1/30
40	415	10	240/415	15	FAZT-D40/4	142508	1/30

Technical Data

		FAZ-T
Productstandard		IEC/EN 60947-2, IEC/EN 60898-1
Classified according to		IEC 61373, EN 45545-2
Current test marks as printed onto the device		
Number of poles		1, 1p+N, 2, 3, 3p+N, 4
Mechanical		
Device width		17.7 mm (1p), 27 mm (1p+N), 36 mm (2p), 54 mm (3p), 72 mm (3p+N), 72 mm (4p)
Frame size		45 mm
Device height		80 mm
Device depth		60 mm
Terminals		lift terminal
Terminal capacity rigid solid/stranded wire		1-25 mm ²
Terminal screw		M5 (with slotted screw acc. to EN ISO 4757-Z2, PZ2)
Fastening torque of terminal screws		max. 2.4 Nm
Snap on fixing		tristable (on DIN rail acc. to EN 50022)
Finger proof		acc. to VBG4, ÖVE EN-6
Degree of protection (DIN VDE 0470)		
Surface mounted		IP20
Built-in behind panel		IP40
Contact position indicator		red / green
Electrical		
Rated voltage	U_n	255/440 V AC (Characteristic B, C), 240/415 V AC (Characteristic D) 60 V DC per pole
Rated current	I_n	Type B, C, D: 1, 2, 3, 4, 6, 10, 12, 13, 15, 16, 20, 25, 32, 40 A
Rated insulation voltage	U_i	440 V AC
Rated impulse withstand voltage	U_{imp}	4 kV (1.2/50) μ sec
Tripping characteristic		
Conventional non-tripping current	I_{nt}	$I_{nt} = 1,13 I_n$
Conventional tripping current	I_t	$I_t = 1,45 I_n$
Reference temperature		40 °C
Temperature factor		0.4%/K
Instantaneous tripping current	I_{mt}	Type B: $3 I_n < I_{mt} = 5 I_n \cdot t (I_{mt}) < 0.1 \text{ sec}$ Type C: $5 I_n < I_{mt} = 10 I_n \cdot t (I_{mt}) < 0.1 \text{ sec}$ Type D: $10 I_n < I_{mt} = 20 I_n \cdot t (I_{mt}) < 0.1 \text{ sec}$
Rated ultimate short-circuit breaking capacity I_{cu} (IEC/EN 60947-2)		Type B 1-25 A: 25 kA, 32-40 A: 20 kA Type C 1-25 A: 25 kA, 32-40 A: 20 kA Type D 1p/1p+N/2p - 1-13 A: 25 kA, 15-20 A: 20 kA, 25-40 A: 15 kA 3p/3p+N/4p - 1-16 A: 25 kA, 20 A: 20 kA, 25-40 A: 15 kA
Rated service short-circuit breaking capacity I_{cs} (IEC/EN 60947-2)		for $I_{cu} = 25 \text{ kA} \rightarrow I_{cs} = 12.5 \text{ kA}$: 240/415 V AC; $I_{cu} = 15 \text{ kA}$: 255/440 V AC for $I_{cu} = 20 \text{ kA} \rightarrow I_{cs} = 10 \text{ kA}$: 240/415 V AC; $I_{cu} = 15 \text{ kA}$: 255/440 V AC for $I_{cu} = 15 \text{ kA} \rightarrow I_{cs} = 7.5 \text{ kA}$
Rated short-circuit breaking capacity I_{cn} (IEC/EN 60898-1)		Type B 1-25 A: 15 kA, 32-40 A: 10 kA Type C 1-25 A: 15 kA, 32-40 A: 10 kA Type D 1-16 A: 15 kA, 20-40 A: 10 kA
Selectivity class		3 (acc. to EN 60898)
Number of electrical operations		> 4.000 (IEC/EN 60898)
Number of mechanical operations		> 10,000 (IEC/EN 60947)
Climatic conditions		acc. to IEC 60068-2-30 (25..55°C / 90..95% RH)
Operating temperature range		-40°C up to +75°C
Storage- and transport temperature		-40°C up to +75°C

Connection diagram

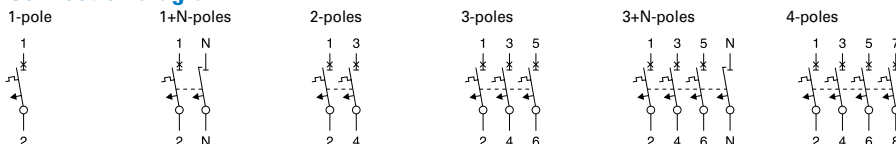

Dimensions (mm) FAZ-T

1-pole

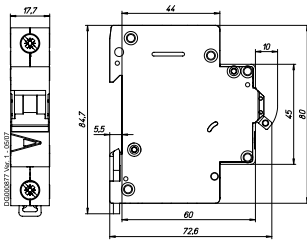

1+N-poles

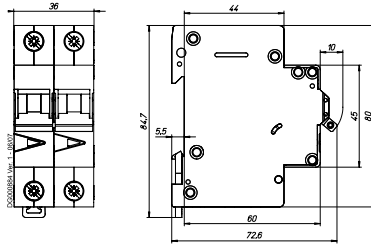

2-poles

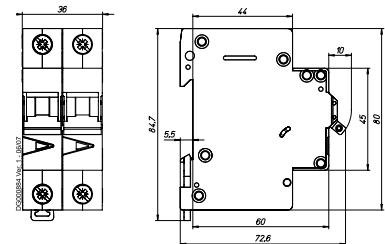

3-poles

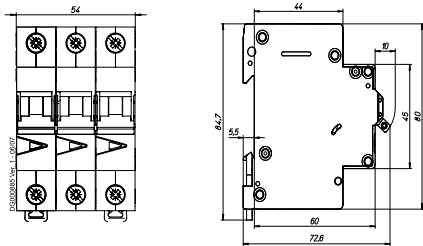

3+N-poles, 4-poles

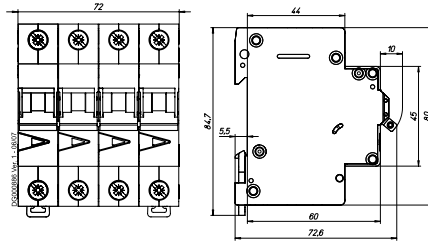

Tripping Characteristics FAZ-T

Characteristics B, C and D - EN60898

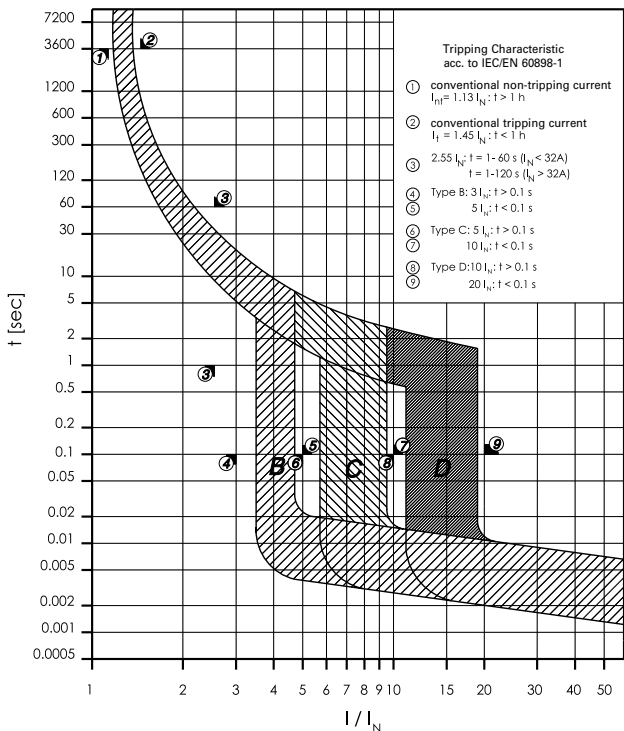

Power Loss at I_n FAZ-T (50/60 Hz)

Type B						
I_n [A]	1p P [W]	1pN P [W]	2p P [W]	3p P [W]	3pN* P [W]	4p P [W]
1	1.6	1.7	3.1	4.7	4.8	6.3
2	1.4	1.5	2.8	4.1	4.3	5.5
3	2.5	2.7	5.0	7.6	7.8	10.1
4	1.4	1.6	2.9	4.4	4.5	5.8
6	1.8	2.0	3.6	5.5	5.6	7.3
10	1.9	2.1	3.9	5.9	6.1	7.8
12	2.8	3.2	5.9	8.7	9.0	11.5
13	2.5	2.9	5.3	7.8	8.1	10.3
15	2.1	2.4	4.4	6.5	6.7	8.6
16	2.2	2.6	4.7	6.9	7.2	9.1
20	3.2	3.6	6.6	9.8	10.1	13.0
25	3.0	3.5	6.4	9.4	9.7	12.4
32	3.7	4.4	8.1	12.1	12.5	15.8
40	3.4	4.1	7.5	11.2	11.5	14.6

* symmetrical load

Type C						
I_n [A]	1p P [W]	1pN P [W]	2p P [W]	3p P [W]	3pN* P [W]	4p P [W]
1	1.6	1.7	3.1	4.7	4.8	6.3
2	1.4	1.5	2.8	4.1	4.3	5.5
3	1.2	1.3	2.4	3.6	3.7	4.8
4	1.4	1.6	2.9	4.4	4.5	5.8
6	1.5	1.6	2.9	4.4	4.6	5.9
10	1.5	1.7	3.0	4.6	4.7	6.1
12	2.1	2.4	4.4	6.5	6.8	8.6
13	2.5	2.9	5.3	7.8	8.1	10.3
15	2.1	2.4	4.4	6.5	6.7	8.6
16	2.2	2.6	4.7	6.9	7.2	9.1
20	3.2	3.6	6.6	9.8	10.1	13.0
25	3.0	3.5	6.4	9.4	9.7	12.4
32	3.7	4.4	8.1	12.1	12.5	15.8
40	3.4	4.1	7.5	11.2	11.5	14.6

* symmetrical load

Type D						
I_n [A]	1p P [W]	1pN P [W]	2p P [W]	3p P [W]	3pN* P [W]	4p P [W]
1	0.8	0.9	1.6	2.4	2.5	3.2
2	1.0	1.1	2.0	3.0	3.1	4.0
3	1.2	1.3	2.4	3.6	3.7	4.8
4	1.4	1.6	2.9	4.4	4.5	5.8
6	1.5	1.6	2.9	4.4	4.6	5.9
10	1.5	1.7	3.0	4.6	4.7	6.1
12	1.7	2.0	3.6	5.3	5.4	7.0
13	1.9	2.2	4.0	5.9	6.1	7.8
15	2.1	2.4	4.4	6.5	6.7	8.6
16	2.2	2.6	4.7	6.9	7.2	9.1
20	2.0	2.2	4.1	6.1	6.2	8.1
25	2.5	2.9	5.2	7.7	7.9	10.2
32	3.4	4.0	7.4	11.1	11.4	14.5
40	3.2	3.8	7.0	10.4	10.7	13.6

* symmetrical load

Influence of Ambient Temperature FAZ-T

On Load Carrying Capacity (temperature derating)

I_n [A]	Ambient temperature T [°C]																
	-40	-30	-20	-10	0	10	20	30	35	40	45	50	55	60	65	70	75
1	1.3	1.2	1.2	1.2	1.1	1.1	1	1	0.99	0.97	0.95	0.93	0.9	0.89	0.87	0.85	0.83
2	2.6	2.5	2.4	2.3	2.2	2.2	2.1	2	2	1.9	1.9	1.9	1.8	1.8	1.7	1.7	1.7
3	3.8	3.7	3.6	3.5	3.4	3.3	3.1	3	3	2.9	2.8	2.8	2.7	2.7	2.6	2.5	2.5
4	5.1	5	4.8	4.7	4.5	4.3	4.2	4	3.9	3.9	3.8	3.7	3.6	3.5	3.5	3.4	3.3
6	7.7	7.5	7.2	7	6.7	6.5	6.3	6	5.9	5.8	5.7	5.6	5.4	5.3	5.2	5.1	5
10	13	12	12	12	11	11	10	10	9.9	9.7	9.5	9.3	9	8.9	8.7	8.5	8.3
12	15	15	14	14	13	13	13	12	12	12	11	11	11	11	10	10	10
13	17	16	16	15	15	14	14	13	13	13	12	12	12	12	11	11	11
15	19	19	18	17	17	16	16	15	15	15	14	14	14	13	13	13	12
16	20	20	19	19	18	17	17	16	16	15	15	15	14	14	14	14	13
20	26	25	24	23	22	22	21	20	20	19	19	19	18	18	17	17	17
25	32	31	30	29	28	27	26	25	25	24	24	23	23	22	22	21	21
32	41	40	38	37	36	35	33	32	32	31	30	30	29	28	28	27	26
40	51	50	48	47	45	43	42	40	39	39	38	37	36	35	35	34	33

Maximum Let-Through Energy FAZ-T

Type B

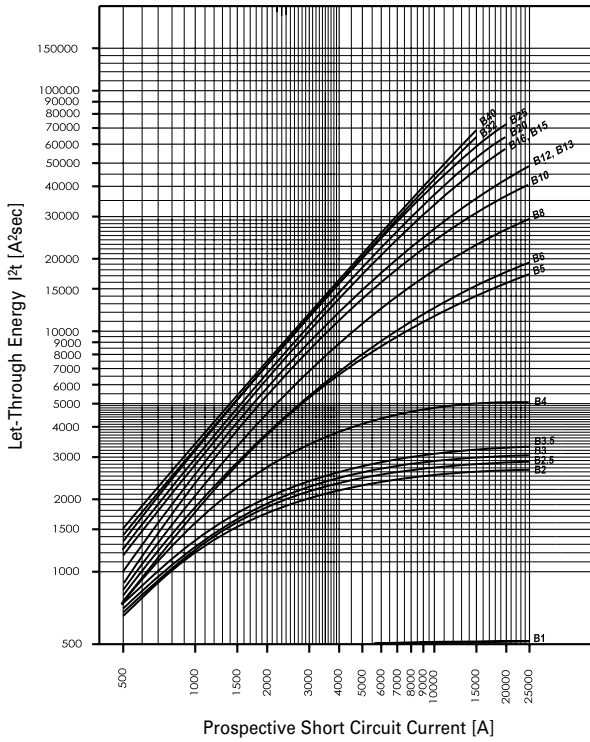

Type C

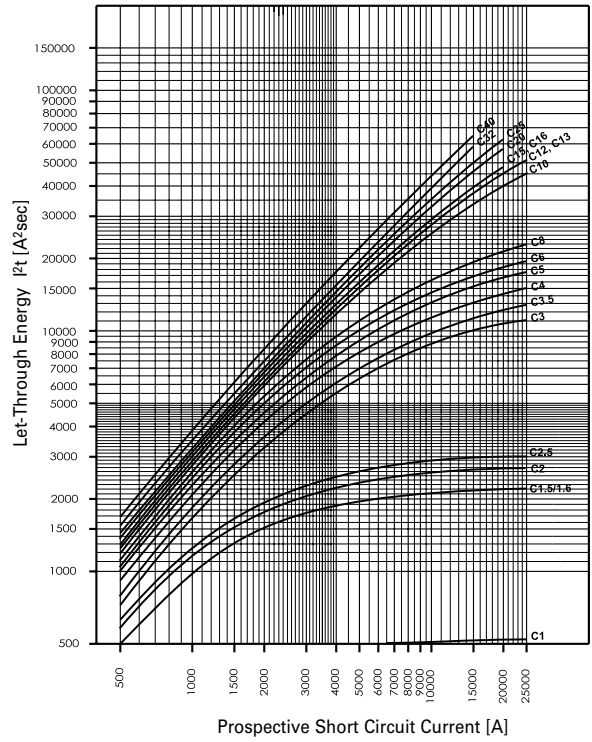

Type D

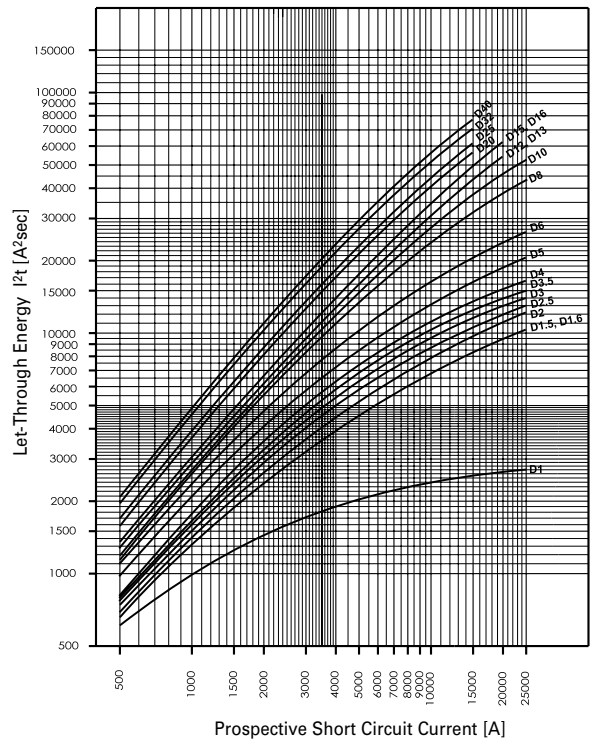

Maximum Let-Through Current FAZ-T

Type B

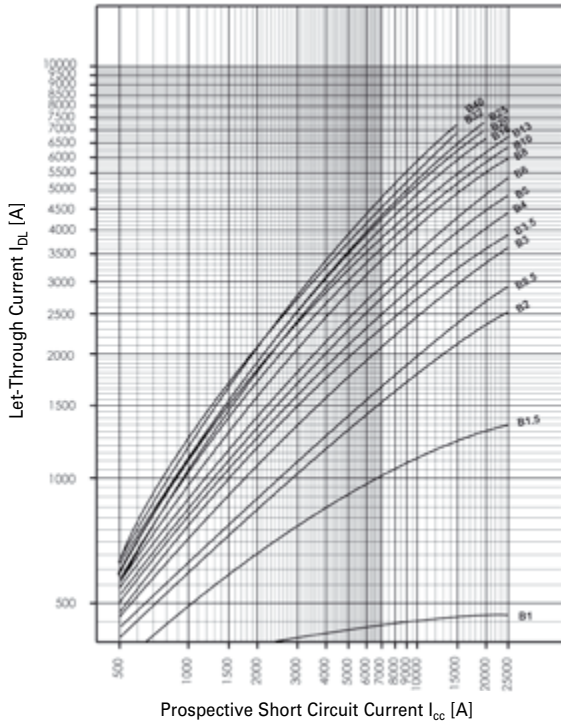

Type C

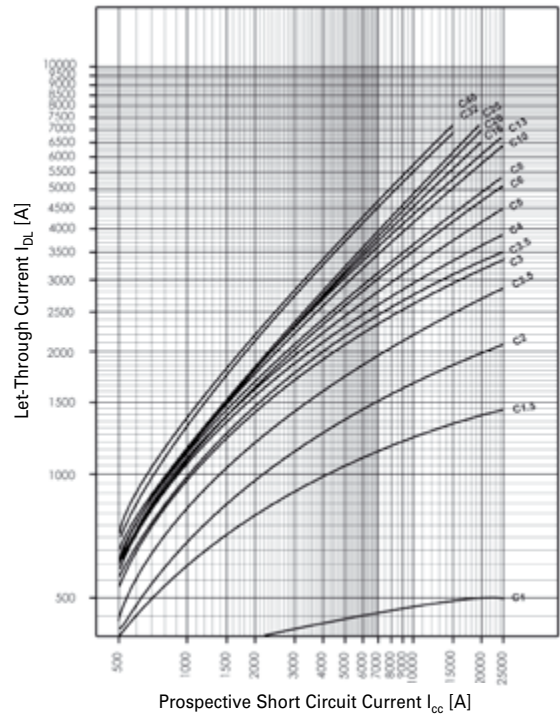

Type D

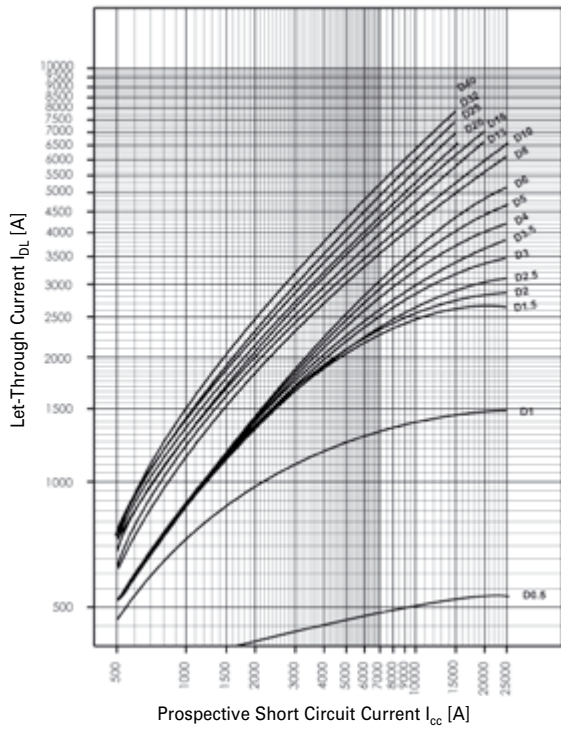

Influence of the Line Frequency FAZ-T

On the Instantaneous Tripping Current I_{MA}

	Line Frequency f [Hz]						
	16 ² / ₃	50	60	100	200	300	400
$I_{MA}(f)/I_{MA}(50\text{ Hz})$ [%]	91	100	101	106	115	134	141

The use of the products in networks with other frequencies than 50/60 Hz are in the customer's responsibility.

Load rating in case of circuit breakers arranged one next to the other FAZ-T

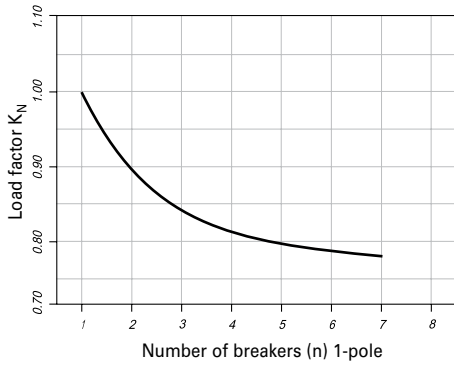

Derating table for FAZ/FAZ-T above 2000m sea level

60898	60947
U_n 230/400V	U_n 230/400V
B, C, D ≤63A	B, C ≤63A and D ≤40A
	D50, D63
	B, C, D ≤63A

Above sea level (m)	Overvoltage category	Disconnect function	I/I_n	I_{cn}	I_{cs}	I_{cu}		I_{cs}
m	x	x	x	kA	kA	kA	kA	kA
≤2000	III	yes	1	10	7.5	15	10	7.5
>2000-2500	II	no	0.93	6	6	10	6	6
>2500-3000	II	no	0.88	6	6	10	6	6
>3000-3500	II	no	0.83	6	6	10	6	6
>3500-4000	II	no	0.78	6	6	10	6	6

WA_SG40320



Description

FAZ-DC

- High-quality miniature circuit breakers for DC-applications
- Contact position indicator red - green
- Guide for secure terminal connection (not for FAZ-NA)
- 3-position DIN rail clip, permits removal from existing busbar system
- Comprehensive range of accessories suitable for subsequent installation
- Rated currents up to 50 A
- Tripping characteristic C
- Rated breaking capacity 10 kA according to IEC/EN 60947-2
- Up to 250 V DC per pole
- Classified for the use in rail rolling stock

Rated current I_n (A)	Rated voltage acc. to IEC/EN 60947-2 (V DC)	Breaking capacity acc. to IEC/EN 60947-2 (kA)	Type Designation	Article No.	Units per package
----------------------------	---	--	---------------------	-------------	----------------------

Characteristic B

SG54512



1-pole

2	220	10	FAZ-B2/1-DC	176063	12/120
3	250	10	FAZ-B3/1-DC	176064	12/120
4	250	10	FAZ-B4/1-DC	176065	12/120
6	250	10	FAZ-B6/1-DC	176066	12/120
8	250	10	FAZ-B8/1-DC	305864	12/120
10	250	10	FAZ-B10/1-DC	176067	12/120
13	250	10	FAZ-B13/1-DC	176068	12/120
16	250	10	FAZ-B16/1-DC	176069	12/120
20	250	10	FAZ-B20/1-DC	176070	12/120
25	250	10	FAZ-B25/1-DC	176071	12/120
32	250	10	FAZ-B32/1-DC	176072	12/120
40	250	10	FAZ-B40/1-DC	176073	12/120
50	250	10	FAZ-B50/1-DC	176074	12/120

WA_SG40320



2-poles

2	440	10	FAZ-B2/2-DC	176075	1/60
3	500	10	FAZ-B3/2-DC	176076	1/60
4	500	10	FAZ-B4/2-DC	176077	1/60
6	500	10	FAZ-B6/2-DC	176078	1/60
8	250	10	FAZ-B8/2-DC	305867	1/60
10	500	10	FAZ-B10/2-DC	176079	1/60
13	500	10	FAZ-B13/2-DC	176080	1/60
16	500	10	FAZ-B16/2-DC	176081	1/60
20	500	10	FAZ-B20/2-DC	176082	1/60
25	500	10	FAZ-B25/2-DC	176083	1/60
32	500	10	FAZ-B32/2-DC	176084	1/60
40	500	10	FAZ-B40/2-DC	176085	1/60
50	500	10	FAZ-B50/2-DC	176086	1/60

Rated current I_n (A)	Rated voltage acc. to IEC/EN 60947-2 (V DC)	Breaking capacity acc. to IEC/EN 60947-2 (kA)	Type Designation	Article No.	Units per package
----------------------------	---	--	---------------------	-------------	----------------------

Characteristic C

SG54612



1-pole

2	220	10	FAZ-C2/1-DC	279122	12/120
3	250	10	FAZ-C3/1-DC	279123	12/120
4	250	10	FAZ-C4/1-DC	279124	12/120
6	250	10	FAZ-C6/1-DC	279125	12/120
8	250	10	FAZ-C8/1-DC	305865	12/120
10	250	10	FAZ-C10/1-DC	279126	12/120
13	250	10	FAZ-C13/1-DC	279127	12/120
16	250	10	FAZ-C16/1-DC	279128	12/120
20	250	10	FAZ-C20/1-DC	279129	12/120
25	250	10	FAZ-C25/1-DC	279130	12/120
32	250	10	FAZ-C32/1-DC	279131	12/120
40	250	10	FAZ-C40/1-DC	279132	12/120
50	250	10	FAZ-C50/1-DC	279133	12/120

WA_SG40320



2-poles

2	440	10	FAZ-C2/2-DC	279134	1/60
3	500	10	FAZ-C3/2-DC	279135	1/60
4	500	10	FAZ-C4/2-DC	279136	1/60
6	500	10	FAZ-C6/2-DC	279137	1/60
8	250	10	FAZ-C8/2-DC	305868	1/60
10	500	10	FAZ-C10/2-DC	279138	1/60
13	500	10	FAZ-C13/2-DC	279139	1/60
16	500	10	FAZ-C16/2-DC	279140	1/60
20	500	10	FAZ-C20/2-DC	279141	1/60
25	500	10	FAZ-C25/2-DC	279142	1/60
32	500	10	FAZ-C32/2-DC	279143	1/60
40	500	10	FAZ-C40/2-DC	279144	1/60
50	500	10	FAZ-C50/2-DC	279145	1/60

Technical Data

		FAZ-DC *)
Productstandard		IEC/EN 60947-2
Classified according to		IEC 61373, EN 45545-2
Current test marks as printed onto the device		
Number of poles		1, 2
Mechanical		
Device width		17.7 mm (1p), 36 mm (2p)
Frame size		45 mm
Device height		80 mm
Device depth		60 mm
Terminals		lift terminal
Terminal capacity rigid solid/stranded wire		1-25 mm ²
Terminal screw		M5 (with slotted screw acc. to EN ISO 4757-Z2, PZ2)
Fastening torque of terminal screws		max. 2.4 Nm
Snap on fixing		tristable (on DIN rail acc. to EN 50022)
Finger proof		acc. to VBG4, ÖVE EN-6
Degree of protection (DIN VDE 0470)		
Surface mounted		IP20
Built-in behind panel		IP40
Contact position indicator		red / green
Electrical		
Rated voltage DC	U_n	2 A Type: 220V (per pole) 3-50 A Typen: 250V (per pole)
Rated current	I_n	Type C: 2, 3, 4, 6, 8, 10, 13, 16, 20, 25, 32, 40, 50 A
Rated insulation voltage	U_i	440 V AC
Rated impulse withstand voltage	U_{imp}	4 kV (1.2/50) µsec
Tripping characteristic		
Conventional non-tripping current	I_{nt}	$I_{nt} = 1,13 I_n$
Conventional tripping current	I_t	$I_t = 1,45 I_n$
Reference temperature		40 °C
Temperature factor		0.4%/K
Instantaneous tripping current	I_{mt}	Type B: $4 I_n < I_{mt} = 7 I_n$; $t(I_{mt}) < 0.1$ sec Type C: $7 I_n < I_{mt} = 15 I_n$; $t(I_{mt}) < 0.1$ sec
Rated short-circuit breaking capacity	I_{cn}	10 kA
Selectivity class		3
Number of electrical operations		> 4.000
Number of mechanical operations		> 20.000
Climatic conditions		acc. to IEC 60068-2-30 (25..55°C / 90..95% RH)
Operating temperature range		-40°C up to +75°C
Storage- and transport temperature		-40°C up to +75°C

*) not for PV string protection!

Connection diagram

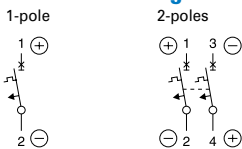

Dimensions (mm) FAZ-...-DC

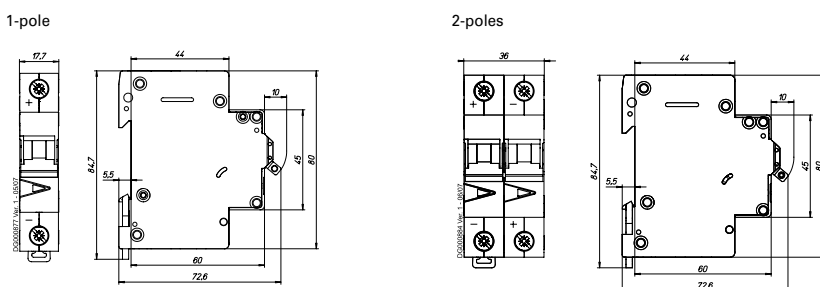

Connection examples FAZ-...-DC

Connection example at 250V=, 1-pole

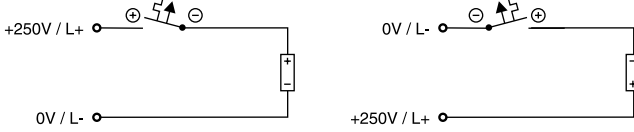

Connection example at 500V=, 2-poles

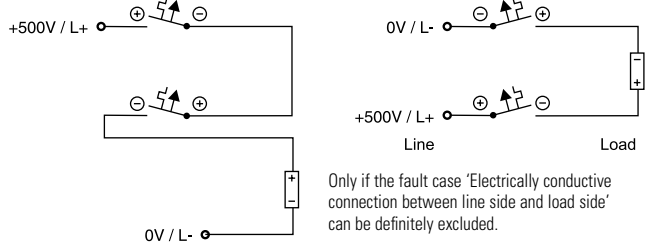

Tripping Characteristics FAZ-...-DC

Characteristics C - IEC/EN 60947-2

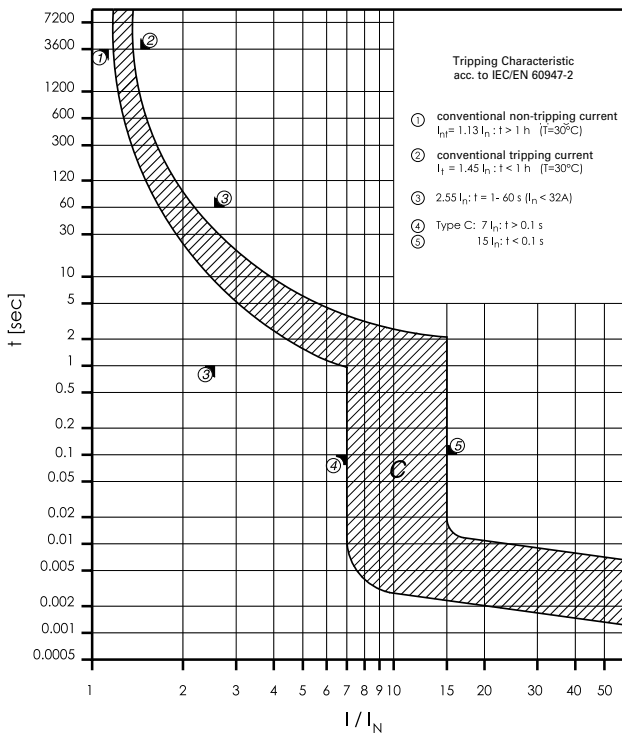

Maximum Let-Through Energy FAZ-...-DC

Type C

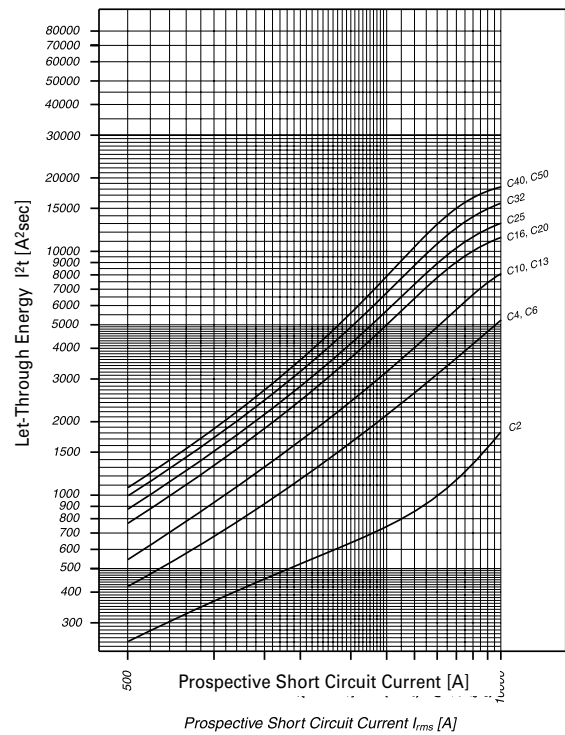

SG56912



Description

FAZ-NA, FAZ-RT

- According to UL 489, CSA C22.2 No. 5 and also IEC 60947-2 standard
- For Applications, which are permitted for UL 1077 or CSA C22.2 No. 235
- Auxiliary switch and voltage trips suitable for subsequent installation
- Serie with removable terminal screws (Type FAZ-...-RT), for use with ring cable lug
- Contact position indicator red - green
- Easy mounting at DIN-rail
- Classified for the use in rail rolling stock

Rated current I_n (A)	Rated voltage acc. to IEC/EN 60947-2 (V)	Breaking capacity acc. to IEC/EN 60947-2 (kA)	Rated voltage acc. to UL489 (V)	Breaking capacity acc. to UL489 (kA)	SWD	NFPA 79	Type Designation	Article No.	Units per package
----------------------------	--	--	--	--	-----	---------	---------------------	-------------	----------------------

Characteristic B

SG53012



1-pole

1	254	15	277	10	SWD	AWG 18	FAZ-B1/1-NA	132414	2/80
1.5	254	15	277	10	SWD	AWG 18	FAZ-B1.5/1-NA	132415	2/80
2	254	15	277	10	SWD	AWG 18	FAZ-B2/1-NA	132416	2/80
3	254	15	277	10	SWD	AWG 18	FAZ-B3/1-NA	132417	2/80
4	254	15	277	10	SWD	AWG 18	FAZ-B4/1-NA	132418	2/80
5	254	15	277	10	SWD	AWG 18	FAZ-B5/1-NA	132419	2/80
6	254	15	277	10	SWD	AWG 18	FAZ-B6/1-NA	132680	2/80
7	254	15	277	10	SWD	AWG 18	FAZ-B7/1-NA	132681	2/80
8	254	15	277	10	SWD	AWG 16	FAZ-B8/1-NA	132682	2/80
10	254	15	277	10	SWD	AWG 16	FAZ-B10/1-NA	132683	2/80
13	254	15	277	10	SWD		FAZ-B13/1-NA	132684	2/80
15	254	15	277	14	SWD		FAZ-B15/1-NA	132685	2/80
16	254	15	277	14	SWD		FAZ-B16/1-NA	132686	2/80
20	254	15	277	14	SWD		FAZ-B20/1-NA	132687	2/80
25	254	15	277	14			FAZ-B25/1-NA	132688	2/80
30	254	15	277	10			FAZ-B30/1-NA	132689	2/80
32	254	15	277	10			FAZ-B32/1-NA	132690	2/80
35	254	15	240	10			FAZ-B35/1-NA	132691	2/80
40	254	15	240	10			FAZ-B40/1-NA	132692	2/80
50	240	15	240	10			FAZ-B50/1-NA	190779	2/80
63	240	15	240	10			FAZ-B63/1-NA	190780	2/80

SG56812



2-poles

1	440	15	480Y/277	10	SWD	AWG 18	FAZ-B1/2-NA	132693	1/40
1.5	440	15	480Y/277	10	SWD	AWG 18	FAZ-B1.5/2-NA	132694	1/40
2	440	15	480Y/277	10	SWD	AWG 18	FAZ-B2/2-NA	132695	1/40
3	440	15	480Y/277	10	SWD	AWG 18	FAZ-B3/2-NA	132696	1/40
4	440	15	480Y/277	10	SWD	AWG 18	FAZ-B4/2-NA	132697	1/40
5	440	15	480Y/277	10	SWD	AWG 18	FAZ-B5/2-NA	132698	1/40
6	440	15	480Y/277	10	SWD	AWG 18	FAZ-B6/2-NA	132699	1/40
7	440	15	480Y/277	10	SWD	AWG 18	FAZ-B7/2-NA	132700	1/40
8	440	15	480Y/277	10	SWD	AWG 16	FAZ-B8/2-NA	132701	1/40
10	440	15	480Y/277	10	SWD	AWG 16	FAZ-B10/2-NA	132702	1/40
13	440	15	480Y/277	10	SWD		FAZ-B13/2-NA	132703	1/40
15	440	15	480Y/277	14	SWD		FAZ-B15/2-NA	132704	1/40
16	440	15	480Y/277	14	SWD		FAZ-B16/2-NA	132705	1/40
20	440	15	480Y/277	14	SWD		FAZ-B20/2-NA	132706	1/40
25	440	15	480Y/277	14			FAZ-B25/2-NA	132707	1/40
30	440	15	480Y/277	10			FAZ-B30/2-NA	132708	1/40
32	440	15	480Y/277	10			FAZ-B32/2-NA	132709	1/40
35	440	15	240	10			FAZ-B35/2-NA	132710	1/40
40	440	15	240	10			FAZ-B40/2-NA	132711	1/40
50	415	15	240	10			FAZ-B50/2-NA	190783	1/40
63	415	15	240	10			FAZ-B63/2-NA	190784	1/40

Rated current I_n (A)	Rated voltage acc. to IEC/EN 60947-2 (V)	Breaking capacity acc. to IEC/EN 60947-2 (kA)	Rated voltage acc. to UL489 (V)	Breaking capacity acc. to UL489 (kA)	SWD	NFPA 79	Type Designation	Article No.	Units per package
3-poles									
1	440	15	480Y/277	10	SWD	AWG 18	FAZ-B1/3-NA	132712	1/28
1.5	440	15	480Y/277	10	SWD	AWG 18	FAZ-B1.5/3-NA	132713	1/28
2	440	15	480Y/277	10	SWD	AWG 18	FAZ-B2/3-NA	132714	1/28
3	440	15	480Y/277	10	SWD	AWG 18	FAZ-B3/3-NA	132715	1/28
4	440	15	480Y/277	10	SWD	AWG 18	FAZ-B4/3-NA	132716	1/28
5	440	15	480Y/277	10	SWD	AWG 18	FAZ-B5/3-NA	132717	1/28
6	440	15	480Y/277	10	SWD	AWG 18	FAZ-B6/3-NA	132718	1/28
7	440	15	480Y/277	10	SWD	AWG 18	FAZ-B7/3-NA	132719	1/28
8	440	15	480Y/277	10	SWD	AWG 16	FAZ-B8/3-NA	132720	1/28
10	440	15	480Y/277	10	SWD	AWG 16	FAZ-B10/3-NA	132721	1/28
13	440	15	480Y/277	10	SWD		FAZ-B13/3-NA	132722	1/28
15	440	15	480Y/277	14	SWD		FAZ-B15/3-NA	132723	1/28
16	440	15	480Y/277	14	SWD		FAZ-B16/3-NA	132724	1/28
20	440	15	480Y/277	14	SWD		FAZ-B20/3-NA	132725	1/28
25	440	15	480Y/277	14			FAZ-B25/3-NA	132726	1/28
30	440	15	480Y/277	10			FAZ-B30/3-NA	132727	1/28
32	440	15	480Y/277	10			FAZ-B32/3-NA	132728	1/28
35	440	15	240	10			FAZ-B35/3-NA	132729	1/28
40	440	15	240	10			FAZ-B40/3-NA	132730	1/28
50	415	15	240	10			FAZ-B50/3-NA	190787	1/28
63	415	15	240	10			FAZ-B63/3-NA	190788	1/28

SG56912



4-poles									
1	440	15	480Y/277	10		AWG18	FAZ-B1/4-NA	190899	1/20
1.5	440	15	480Y/277	10		AWG18	FAZ-B1.5/4-NA	190900	1/20
2	440	15	480Y/277	10		AWG18	FAZ-B2/4-NA	190901	1/20
3	440	15	480Y/277	10		AWG18	FAZ-B3/4-NA	190902	1/20
4	440	15	480Y/277	10		AWG18	FAZ-B4/4-NA	190903	1/20
5	440	15	480Y/277	10		AWG18	FAZ-B5/4-NA	190904	1/20
6	440	15	480Y/277	10		AWG18	FAZ-B6/4-NA	190905	1/20
7	440	15	480Y/277	10		AWG18	FAZ-B7/4-NA	190906	1/20
8	440	15	480Y/277	10		AWG16	FAZ-B8/4-NA	190927	1/20
10	440	15	480Y/277	10		AWG16	FAZ-B10/4-NA	190928	1/20
13	440	15	480Y/277	10			FAZ-B13/4-NA	190907	1/20
15	440	15	480Y/277	14			FAZ-B15/4-NA	190908	1/20
16	440	15	480Y/277	14			FAZ-B16/4-NA	190909	1/20
20	440	15	480Y/277	14			FAZ-B20/4-NA	190910	1/20
25	440	15	480Y/277	14			FAZ-B25/4-NA	190911	1/20
30	440	15	480Y/277	10			FAZ-B30/4-NA	190912	1/20
32	440	15	480Y/277	10			FAZ-B32/4-NA	190913	1/20
35	440	15	240	10			FAZ-B35/4-NA	190914	1/20
40	440	15	240	10			FAZ-B40/4-NA	190915	1/20
50	415	15	240	10			FAZ-B50/4-NA	190789	1/20
63	415	15	240	10			FAZ-B63/4-NA	190790	1/20

wa_sg01017



Rated current I_n (A)	Rated voltage acc. to IEC/EN 60947-2 (V)	Breaking capacity acc. to IEC/EN 60947-2 (kA)	Rated voltage acc. to UL489 (V)	Breaking capacity acc. to UL489 (kA)	SWD	NFPA 79	Type Designation	Article No.	Units per package
----------------------------	--	--	--	--	-----	---------	---------------------	-------------	----------------------

Characteristic C

1-pole

0.5	254	15	277	10	SWD	AWG 18	FAZ-C0,5/1-NA	102077	2/80
1	254	15	277	10	SWD	AWG 18	FAZ-C1/1-NA	102078	2/80
1.5	254	15	277	10	SWD	AWG 18	FAZ-C1,5/1-NA	102079	2/80
2	254	15	277	10	SWD	AWG 18	FAZ-C2/1-NA	102080	2/80
3	254	15	277	10	SWD	AWG 18	FAZ-C3/1-NA	102081	2/80
4	254	15	277	10	SWD	AWG 18	FAZ-C4/1-NA	102082	2/80
5	254	15	277	10	SWD	AWG 18	FAZ-C5/1-NA	102083	2/80
6	254	15	277	10	SWD	AWG 18	FAZ-C6/1-NA	102084	2/80
7	254	15	277	10	SWD	AWG 18	FAZ-C7/1-NA	102085	2/80
8	254	15	277	10	SWD	AWG 16	FAZ-C8/1-NA	102086	2/80
10	254	15	277	10	SWD	AWG 16	FAZ-C10/1-NA	102087	2/80
13	254	15	277	10	SWD		FAZ-C13/1-NA	102088	2/80
15	254	15	277	14	SWD		FAZ-C15/1-NA	102089	2/80
16	254	15	277	14	SWD		FAZ-C16/1-NA	102090	2/80
20	254	15	277	14	SWD		FAZ-C20/1-NA	102091	2/80
25	254	15	277	14			FAZ-C25/1-NA	102092	2/80
30	254	15	277	10			FAZ-C30/1-NA	102093	2/80
32	254	15	277	10			FAZ-C32/1-NA	102094	2/80
35	254	15	240	10			FAZ-C35/1-NA	102095	2/80
40	254	15	240	10			FAZ-C40/1-NA	102096	2/80
50	240	15	240	10			FAZ-C50/1-NA	190781	2/80
63	240	15	240	10			FAZ-C63/1-NA	190782	2/80

SG53012



2-poles

0.5	440	15	480Y/277	10	SWD	AWG 18	FAZ-C0,5/2-NA	102157	1/40
1	440	15	480Y/277	10	SWD	AWG 18	FAZ-C1/2-NA	102158	1/40
1.5	440	15	480Y/277	10	SWD	AWG 18	FAZ-C1,5/2-NA	102159	1/40
2	440	15	480Y/277	10	SWD	AWG 18	FAZ-C2/2-NA	102160	1/40
3	440	15	480Y/277	10	SWD	AWG 18	FAZ-C3/2-NA	102161	1/40
4	440	15	480Y/277	10	SWD	AWG 18	FAZ-C4/2-NA	102162	1/40
5	440	15	480Y/277	10	SWD	AWG 18	FAZ-C5/2-NA	102163	1/40
6	440	15	480Y/277	10	SWD	AWG 18	FAZ-C6/2-NA	102164	1/40
7	440	15	480Y/277	10	SWD	AWG 18	FAZ-C7/2-NA	102165	1/40
8	440	15	480Y/277	10	SWD	AWG 16	FAZ-C8/2-NA	102166	1/40
10	440	15	480Y/277	10	SWD	AWG 16	FAZ-C10/2-NA	102167	1/40
13	440	15	480Y/277	10	SWD		FAZ-C13/2-NA	102168	1/40
15	440	15	480Y/277	14	SWD		FAZ-C15/2-NA	102169	1/40
16	440	15	480Y/277	14	SWD		FAZ-C16/2-NA	102170	1/40
20	440	15	480Y/277	14	SWD		FAZ-C20/2-NA	102171	1/40
25	440	15	480Y/277	14			FAZ-C25/2-NA	102172	1/40
30	440	15	480Y/277	10			FAZ-C30/2-NA	102173	1/40
32	440	15	480Y/277	10			FAZ-C32/2-NA	102174	1/40
35	440	15	240	10			FAZ-C35/2-NA	102175	1/40
40	440	15	240	10			FAZ-C40/2-NA	102176	1/40
50	415	15	240	10			FAZ-C50/2-NA	190785	1/40
63	415	15	240	10			FAZ-C63/2-NA	190786	1/40

SG56812



Rated current I_n (A)	Rated voltage acc. to IEC/EN 60947-2 (V)	Breaking capacity acc. to IEC/EN 60947-2 (kA)	Rated voltage acc. to UL489 (V)	Breaking capacity acc. to UL489 (kA)	SWD	NFPA 79	Type Designation	Article No.	Units per package
3-poles									
0.5	440	15	480Y/277	10	SWD	AWG 18	FAZ-C0,5/3-NA	102237	1/28
1	440	15	480Y/277	10	SWD	AWG 18	FAZ-C1/3-NA	102238	1/28
1.5	440	15	480Y/277	10	SWD	AWG 18	FAZ-C1,5/3-NA	102239	1/28
2	440	15	480Y/277	10	SWD	AWG 18	FAZ-C2/3-NA	102240	1/28
3	440	15	480Y/277	10	SWD	AWG 18	FAZ-C3/3-NA	102241	1/28
4	440	15	480Y/277	10	SWD	AWG 18	FAZ-C4/3-NA	102242	1/28
5	440	15	480Y/277	10	SWD	AWG 18	FAZ-C5/3-NA	102243	1/28
6	440	15	480Y/277	10	SWD	AWG 18	FAZ-C6/3-NA	102244	1/28
7	440	15	480Y/277	10	SWD	AWG 18	FAZ-C7/3-NA	102245	1/28
8	440	15	480Y/277	10	SWD	AWG 16	FAZ-C8/3-NA	102246	1/28
10	440	15	480Y/277	10	SWD	AWG 16	FAZ-C10/3-NA	102247	1/28
13	440	15	480Y/277	10	SWD		FAZ-C13/3-NA	102248	1/28
15	440	15	480Y/277	14	SWD		FAZ-C15/3-NA	102249	1/28
16	440	15	480Y/277	14	SWD		FAZ-C16/3-NA	102250	1/28
20	440	15	480Y/277	14	SWD		FAZ-C20/3-NA	102251	1/28
25	440	15	480Y/277	14			FAZ-C25/3-NA	102252	1/28
30	440	15	480Y/277	10			FAZ-C30/3-NA	102253	1/28
32	440	15	480Y/277	10			FAZ-C32/3-NA	102254	1/28
35	440	15	240	10			FAZ-C35/3-NA	102255	1/28
40	440	15	240	10			FAZ-C40/3-NA	102256	1/28
50	415	15	240	10			FAZ-C50/3-NA	190791	1/28
63	415	15	240	10			FAZ-C63/3-NA	190792	1/28

SG56912



4-poles									
0.5	440	15	480Y/277	10		AWG18	FAZ-C0,5/4-NA	190916	1/20
1	440	15	480Y/277	10		AWG18	FAZ-C1/4-NA	190917	1/20
1.5	440	15	480Y/277	10		AWG18	FAZ-C1,5/4-NA	190918	1/20
2	440	15	480Y/277	10		AWG18	FAZ-C2/4-NA	190919	1/20
3	440	15	480Y/277	10		AWG18	FAZ-C3/4-NA	190920	1/20
4	440	15	480Y/277	10		AWG18	FAZ-C4/4-NA	190921	1/20
5	440	15	480Y/277	10		AWG18	FAZ-C5/4-NA	190922	1/20
6	440	15	480Y/277	10		AWG18	FAZ-C6/4-NA	190923	1/20
7	440	15	480Y/277	10		AWG18	FAZ-C7/4-NA	190924	1/20
8	440	15	480Y/277	10		AWG16	FAZ-C8/4-NA	190925	1/20
10	440	15	480Y/277	10		AWG16	FAZ-C10/4-NA	190926	1/20
13	440	15	480Y/277	10			FAZ-C13/4-NA	190815	1/20
15	440	15	480Y/277	14			FAZ-C15/4-NA	190816	1/20
16	440	15	480Y/277	14			FAZ-C16/4-NA	190817	1/20
20	440	15	480Y/277	14			FAZ-C20/4-NA	190818	1/20
25	440	15	480Y/277	14			FAZ-C25/4-NA	190819	1/20
30	440	15	480Y/277	10			FAZ-C30/4-NA	190820	1/20
32	440	15	480Y/277	10			FAZ-C32/4-NA	190821	1/20
35	440	15	240	10			FAZ-C35/4-NA	190822	1/20
40	440	15	240	10			FAZ-C40/4-NA	190823	1/20
50	415	15	240	10			FAZ-C50/4-NA	190793	1/20
63	415	15	240	10			FAZ-C63/4-NA	190794	1/20

wa_sg01017



2.244

Miniature Circuit Breakers

xEffect

FAZ-...-NA Miniature Circuit Breakers

Rated current I_n (A)	Rated voltage acc. to IEC/EN 60947-2 (V)	Breaking capacity acc. to IEC/EN 60947-2 (kA)	Rated voltage acc. to UL489 (V)	Breaking capacity acc. to UL489 (kA)	SWD	NFPA 79	Type Designation	Article No.	Units per package
----------------------------	--	--	--	--	-----	---------	---------------------	-------------	----------------------

Characteristic D

SG53012



1-pole

0.5	240	15	277	10	SWD	AWG 18	FAZ-D0,5/1-NA	102097	2/80
1	240	15	277	10	SWD	AWG 18	FAZ-D1/1-NA	102098	2/80
1.5	240	15	277	10	SWD	AWG 18	FAZ-D1,5/1-NA	102099	2/80
2	240	15	277	10	SWD	AWG 18	FAZ-D2/1-NA	102100	2/80
3	240	15	277	10	SWD	AWG 18	FAZ-D3/1-NA	102101	2/80
4	240	15	277	10	SWD	AWG 18	FAZ-D4/1-NA	102102	2/80
5	240	15	277	10	SWD	AWG 18	FAZ-D5/1-NA	102103	2/80
6	240	15	277	10	SWD	AWG 18	FAZ-D6/1-NA	102104	2/80
7	240	15	277	10	SWD	AWG 18	FAZ-D7/1-NA	102105	2/80
8	240	15	277	10	SWD	AWG 16	FAZ-D8/1-NA	102106	2/80
10	240	15	277	10	SWD	AWG 16	FAZ-D10/1-NA	102107	2/80
13	240	15	277	14	SWD		FAZ-D13/1-NA	102108	2/80
15	240	15	277	14	SWD		FAZ-D15/1-NA	102109	2/80
16	240	15	277	14	SWD		FAZ-D16/1-NA	102110	2/80
20	240	15	277	14	SWD		FAZ-D20/1-NA	102111	2/80
25	240	15	277	10			FAZ-D25/1-NA	102112	2/80
30	240	15	277	10			FAZ-D30/1-NA	102113	2/80
32	240	15	277	10			FAZ-D32/1-NA	102114	2/80
35	240	15	240	10			FAZ-D35/1-NA	102115	2/80
40	240	15	240	10			FAZ-D40/1-NA	102116	2/80

SG56812



2-poles

0.5	415	15	480Y/277	10	SWD	AWG 18	FAZ-D0,5/2-NA	102177	1/40
1	415	15	480Y/277	10	SWD	AWG 18	FAZ-D1/2-NA	102178	1/40
1.5	415	15	480Y/277	10	SWD	AWG 18	FAZ-D1,5/2-NA	102179	1/40
2	415	15	480Y/277	10	SWD	AWG 18	FAZ-D2/2-NA	102180	1/40
3	415	15	480Y/277	10	SWD	AWG 18	FAZ-D3/2-NA	102181	1/40
4	415	15	480Y/277	10	SWD	AWG 18	FAZ-D4/2-NA	102182	1/40
5	415	15	480Y/277	10	SWD	AWG 18	FAZ-D5/2-NA	102183	1/40
6	415	15	480Y/277	10	SWD	AWG 18	FAZ-D6/2-NA	102184	1/40
7	415	15	480Y/277	10	SWD	AWG 18	FAZ-D7/2-NA	102185	1/40
8	415	15	480Y/277	10	SWD	AWG 16	FAZ-D8/2-NA	102186	1/40
10	415	15	480Y/277	10	SWD	AWG 16	FAZ-D10/2-NA	102187	1/40
13	415	15	480Y/277	14	SWD		FAZ-D13/2-NA	102188	1/40
15	415	15	480Y/277	14	SWD		FAZ-D15/2-NA	102189	1/40
16	415	15	480Y/277	14	SWD		FAZ-D16/2-NA	102190	1/40
20	415	15	480Y/277	14	SWD		FAZ-D20/2-NA	102191	1/40
25	415	15	480Y/277	10			FAZ-D25/2-NA	102192	1/40
30	415	15	480Y/277	10			FAZ-D30/2-NA	102193	1/40
32	415	15	480Y/277	10			FAZ-D32/2-NA	102194	1/40
35	415	15	240	10			FAZ-D35/2-NA	102195	1/40
40	415	15	240	10			FAZ-D40/2-NA	102196	1/40

Rated current I_n (A)	Rated voltage acc. to IEC/EN 60947-2 (V)	Breaking capacity acc. to IEC/EN 60947-2 (kA)	Rated voltage acc. to UL489 (V)	Breaking capacity acc. to UL489 (kA)	SWD	NFPA 79	Type Designation	Article No.	Units per package
----------------------------	--	--	--	--	-----	---------	---------------------	-------------	----------------------

SG56912



3-poles

0.5	415	15	480Y/277	10	SWD	AWG 18	FAZ-D0,5/3-NA	102257	1/28
1	415	15	480Y/277	10	SWD	AWG 18	FAZ-D1/3-NA	102258	1/28
1.5	415	15	480Y/277	10	SWD	AWG 18	FAZ-D1,5/3-NA	102259	1/28
2	415	15	480Y/277	10	SWD	AWG 18	FAZ-D2/3-NA	102260	1/28
3	415	15	480Y/277	10	SWD	AWG 18	FAZ-D3/3-NA	102261	1/28
4	415	15	480Y/277	10	SWD	AWG 18	FAZ-D4/3-NA	102262	1/28
5	415	15	480Y/277	10	SWD	AWG 18	FAZ-D5/3-NA	102263	1/28
6	415	15	480Y/277	10	SWD	AWG 18	FAZ-D6/3-NA	102264	1/28
7	415	15	480Y/277	10	SWD	AWG 18	FAZ-D7/3-NA	102265	1/28
8	415	15	480Y/277	10	SWD	AWG 16	FAZ-D8/3-NA	102266	1/28
10	415	15	480Y/277	10	SWD	AWG 16	FAZ-D10/3-NA	102267	1/28
13	415	15	480Y/277	14	SWD		FAZ-D13/3-NA	102268	1/28
15	415	15	480Y/277	14	SWD		FAZ-D15/3-NA	102269	1/28
16	415	15	480Y/277	14	SWD		FAZ-D16/3-NA	102270	1/28
20	415	15	480Y/277	14	SWD		FAZ-D20/3-NA	102271	1/28
25	415	15	480Y/277	10			FAZ-D25/3-NA	102272	1/28
30	415	15	480Y/277	10			FAZ-D30/3-NA	102273	1/28
32	415	15	480Y/277	10			FAZ-D32/3-NA	102274	1/28
35	415	15	240	10			FAZ-D35/3-NA	102275	1/28
40	415	15	240	10			FAZ-D40/3-NA	102276	1/28

wa_sg01017



4-poles

0.5	415	15	480Y/277	10		AWG18	FAZ-D0,5/4-NA	190824	1/20
1	415	15	480Y/277	10		AWG18	FAZ-D1/4-NA	190825	1/20
1.5	415	15	480Y/277	10		AWG18	FAZ-D1,5/4-NA	190826	1/20
2	415	15	480Y/277	10		AWG18	FAZ-D2/4-NA	190827	1/20
3	415	15	480Y/277	10		AWG18	FAZ-D3/4-NA	190828	1/20
4	415	15	480Y/277	10		AWG18	FAZ-D4/4-NA	190829	1/20
5	415	15	480Y/277	10		AWG18	FAZ-D5/4-NA	190830	1/20
6	415	15	480Y/277	10		AWG18	FAZ-D6/4-NA	190831	1/20
7	415	15	480Y/277	10		AWG18	FAZ-D7/4-NA	190832	1/20
8	415	15	480Y/277	10		AWG16	FAZ-D8/4-NA	190833	1/20
10	415	15	480Y/277	10		AWG16	FAZ-D10/4-NA	190834	1/20
13	415	15	480Y/277	10			FAZ-D13/4-NA	190835	1/20
15	415	15	480Y/277	14			FAZ-D15/4-NA	190836	1/20
16	415	15	480Y/277	14			FAZ-D16/4-NA	190837	1/20
20	415	15	480Y/277	14			FAZ-D20/4-NA	190838	1/20
25	415	15	480Y/277	14			FAZ-D25/4-NA	190839	1/20
30	415	15	480Y/277	10			FAZ-D30/4-NA	190840	1/20
32	415	15	480Y/277	10			FAZ-D32/4-NA	190841	1/20
35	415	15	240	10			FAZ-D35/4-NA	190842	1/20
40	415	15	240	10			FAZ-D40/4-NA	190843	1/20

FAZ-...-RT Miniature Circuit Breakers

Rated current I_n (A)	Rated voltage acc. to IEC/EN 60947-2 (V)	Breaking capacity acc. to IEC/EN 60947-2 (kA)	Rated voltage acc. to UL489 (V)	Breaking capacity acc. to UL489 (kA)	SWD	NFPA 79	Type Designation	Article No.	Units per package
----------------------------	--	--	--	--	-----	---------	---------------------	-------------	----------------------

Characteristic B

SG56412



1-pole

1	254	15	277	10	SWD	AWG 18	FAZ-B1/1-RT	132731	2/80
1,5	254	15	277	10	SWD	AWG 18	FAZ-B1,5/1-RT	132732	2/80
2	254	15	277	10	SWD	AWG 18	FAZ-B2/1-RT	132733	2/80
3	254	15	277	10	SWD	AWG 18	FAZ-B3/1-RT	132734	2/80
4	254	15	277	10	SWD	AWG 18	FAZ-B4/1-RT	132735	2/80
5	254	15	277	10	SWD	AWG 18	FAZ-B5/1-RT	132736	2/80
6	254	15	277	10	SWD	AWG 18	FAZ-B6/1-RT	132737	2/80
7	254	15	277	10	SWD	AWG 18	FAZ-B7/1-RT	132738	2/80
8	254	15	277	10	SWD	AWG 16	FAZ-B8/1-RT	132739	2/80
10	254	15	277	10	SWD	AWG 16	FAZ-B10/1-RT	132740	2/80
13	254	15	277	10	SWD		FAZ-B13/1-RT	132741	2/80
15	254	15	277	14	SWD		FAZ-B15/1-RT	132742	2/80
16	254	15	277	14	SWD		FAZ-B16/1-RT	132743	2/80
20	254	15	277	14	SWD		FAZ-B20/1-RT	132744	2/80
25	254	15	277	14			FAZ-B25/1-RT	132745	2/80
30	254	15	277	10			FAZ-B30/1-RT	132746	2/80
32	254	15	277	10			FAZ-B32/1-RT	132747	2/80
35	254	15	240	10			FAZ-B35/1-RT	132748	2/80
40	254	15	240	10			FAZ-B40/1-RT	132749	2/80
50	240	15	240	10			FAZ-B50/1-RT	190795	2/80
63	240	15	240	10			FAZ-B63/1-RT	190796	2/80

SG56712



2-poles

1	440	15	480Y/277	10	SWD	AWG 18	FAZ-B1/2-RT	132750	1/40
1,5	440	15	480Y/277	10	SWD	AWG 18	FAZ-B1,5/2-RT	132751	1/40
2	440	15	480Y/277	10	SWD	AWG 18	FAZ-B2/2-RT	132752	1/40
3	440	15	480Y/277	10	SWD	AWG 18	FAZ-B3/2-RT	132753	1/40
4	440	15	480Y/277	10	SWD	AWG 18	FAZ-B4/2-RT	132754	1/40
5	440	15	480Y/277	10	SWD	AWG 18	FAZ-B5/2-RT	132755	1/40
6	440	15	480Y/277	10	SWD	AWG 18	FAZ-B6/2-RT	132756	1/40
7	440	15	480Y/277	10	SWD	AWG 18	FAZ-B7/2-RT	132757	1/40
8	440	15	480Y/277	10	SWD	AWG 16	FAZ-B8/2-RT	132758	1/40
10	440	15	480Y/277	10	SWD	AWG 16	FAZ-B10/2-RT	132759	1/40
13	440	15	480Y/277	10	SWD		FAZ-B13/2-RT	132760	1/40
15	440	15	480Y/277	14	SWD		FAZ-B15/2-RT	132761	1/40
16	440	15	480Y/277	14	SWD		FAZ-B16/2-RT	132762	1/40
20	440	15	480Y/277	14	SWD		FAZ-B20/2-RT	132763	1/40
25	440	15	480Y/277	14			FAZ-B25/2-RT	132764	1/40
30	440	15	480Y/277	10			FAZ-B30/2-RT	132765	1/40
32	440	15	480Y/277	10			FAZ-B32/2-RT	132766	1/40
35	440	15	240	10			FAZ-B35/2-RT	132767	1/40
40	440	15	240	10			FAZ-B40/2-RT	132768	1/40
50	415	15	240	10			FAZ-B50/2-RT	190799	1/40
63	415	15	240	10			FAZ-B63/2-RT	190800	1/40

Rated current I_n (A)	Rated voltage acc. to IEC/EN 60947-2 (V)	Breaking capacity acc. to IEC/EN 60947-2 (kA)	Rated voltage acc. to UL489 (V)	Breaking capacity acc. to UL489 (kA)	SWD	NFPA 79	Type Designation	Article No.	Units per package
3-poles									
1	440	15	480Y/277	10	SWD	AWG 18	FAZ-B1/3-RT	132769	1/28
1,5	440	15	480Y/277	10	SWD	AWG 18	FAZ-B1,5/3-RT	132770	1/28
2	440	15	480Y/277	10	SWD	AWG 18	FAZ-B2/3-RT	132771	1/28
3	440	15	480Y/277	10	SWD	AWG 18	FAZ-B3/3-RT	132772	1/28
4	440	15	480Y/277	10	SWD	AWG 18	FAZ-B4/3-RT	132773	1/28
5	440	15	480Y/277	10	SWD	AWG 18	FAZ-B5/3-RT	132774	1/28
6	440	15	480Y/277	10	SWD	AWG 18	FAZ-B6/3-RT	132775	1/28
7	440	15	480Y/277	10	SWD	AWG 18	FAZ-B7/3-RT	132776	1/28
8	440	15	480Y/277	10	SWD	AWG 16	FAZ-B8/3-RT	132777	1/28
10	440	15	480Y/277	10	SWD	AWG 16	FAZ-B10/3-RT	132778	1/28
13	440	15	480Y/277	10	SWD		FAZ-B13/3-RT	132779	1/28
15	440	15	480Y/277	14	SWD		FAZ-B15/3-RT	132780	1/28
16	440	15	480Y/277	14	SWD		FAZ-B16/3-RT	132781	1/28
20	440	15	480Y/277	14	SWD		FAZ-B20/3-RT	132782	1/28
25	440	15	480Y/277	14			FAZ-B25/3-RT	132783	1/28
30	440	15	480Y/277	10			FAZ-B30/3-RT	132784	1/28
32	440	15	480Y/277	10			FAZ-B32/3-RT	132785	1/28
35	440	15	240	10			FAZ-B35/3-RT	132786	1/28
40	440	15	240	10			FAZ-B40/3-RT	132787	1/28
50	415	15	240	10			FAZ-B50/3-RT	190803	1/28
63	415	15	240	10			FAZ-B63/3-RT	190804	1/28

SG57012



4-poles									
1	440	15	480Y/277	10		AWG18	FAZ-B1/4-RT	190844	1/20
1,5	440	15	480Y/277	10		AWG18	FAZ-B1,5/4-RT	190845	1/20
2	440	15	480Y/277	10		AWG18	FAZ-B2/4-RT	190846	1/20
3	440	15	480Y/277	10		AWG18	FAZ-B3/4-RT	190847	1/20
4	440	15	480Y/277	10		AWG18	FAZ-B4/4-RT	190848	1/20
5	440	15	480Y/277	10		AWG18	FAZ-B5/4-RT	190849	1/20
6	440	15	480Y/277	10		AWG18	FAZ-B6/4-RT	190850	1/20
7	440	15	480Y/277	10		AWG18	FAZ-B7/4-RT	190851	1/20
8	440	15	480Y/277	10		AWG16	FAZ-B8/4-RT	190852	1/20
10	440	15	480Y/277	10		AWG16	FAZ-B10/4-RT	190853	1/20
13	440	15	480Y/277	10			FAZ-B13/4-RT	190854	1/20
15	440	15	480Y/277	14			FAZ-B15/4-RT	190855	1/20
16	440	15	480Y/277	14			FAZ-B16/4-RT	190856	1/20
20	440	15	480Y/277	14			FAZ-B20/4-RT	190857	1/20
25	440	15	480Y/277	14			FAZ-B25/4-RT	190858	1/20
30	440	15	480Y/277	10			FAZ-B30/4-RT	190859	1/20
32	440	15	480Y/277	10			FAZ-B32/4-RT	190860	1/20
35	440	15	240	10			FAZ-B35/4-RT	190861	1/20
40	440	15	240	10			FAZ-B40/4-RT	190862	1/20
50	415	15	240	10			FAZ-B50/4-RT	190805	1/20
63	415	15	240	10			FAZ-B63/4-RT	190806	1/20

wa_sg01017



FAZ-...-RT Miniature Circuit Breakers

Rated current I_n (A)	Rated voltage acc. to IEC/EN 60947-2 (V)	Breaking capacity acc. to IEC/EN 60947-2 (kA)	Rated voltage acc. to UL489 (V)	Breaking capacity acc. to UL489 (kA)	SWD	NFPA 79	Type Designation	Article No.	Units per package
----------------------------	--	--	--	--	-----	---------	---------------------	-------------	----------------------

Characteristic C

1-pole

0.5	254	15	277	10	SWD	AWG 18	FAZ-C0,5/1-RT	102117	2/80
1	254	15	277	10	SWD	AWG 18	FAZ-C1/1-RT	102118	2/80
1,5	254	15	277	10	SWD	AWG 18	FAZ-C1,5/1-RT	102119	2/80
2	254	15	277	10	SWD	AWG 18	FAZ-C2/1-RT	102120	2/80
3	254	15	277	10	SWD	AWG 18	FAZ-C3/1-RT	102121	2/80
4	254	15	277	10	SWD	AWG 18	FAZ-C4/1-RT	102122	2/80
5	254	15	277	10	SWD	AWG 18	FAZ-C5/1-RT	102123	2/80
6	254	15	277	10	SWD	AWG 18	FAZ-C6/1-RT	102124	2/80
7	254	15	277	10	SWD	AWG 18	FAZ-C7/1-RT	102125	2/80
8	254	15	277	10	SWD	AWG 16	FAZ-C8/1-RT	102126	2/80
10	254	15	277	10	SWD	AWG 16	FAZ-C10/1-RT	102127	2/80
13	254	15	277	10	SWD		FAZ-C13/1-RT	102128	2/80
15	254	15	277	14	SWD		FAZ-C15/1-RT	102129	2/80
16	254	15	277	14	SWD		FAZ-C16/1-RT	102130	2/80
20	254	15	277	14	SWD		FAZ-C20/1-RT	102131	2/80
25	254	15	277	14			FAZ-C25/1-RT	102132	2/80
30	254	15	277	10			FAZ-C30/1-RT	102133	2/80
32	254	15	277	10			FAZ-C32/1-RT	102134	2/80
35	254	15	240	10			FAZ-C35/1-RT	102135	2/80
40	254	15	240	10			FAZ-C40/1-RT	102136	2/80
50	240	15	240	10			FAZ-C50/1-RT	190797	2/80
63	240	15	240	10			FAZ-C63/1-RT	190798	2/80

SG56412



2-poles

0.5	440	15	480Y/277	10	SWD	AWG 18	FAZ-C0,5/2-RT	102197	1/40
1	440	15	480Y/277	10	SWD	AWG 18	FAZ-C1/2-RT	102198	1/40
1,5	440	15	480Y/277	10	SWD	AWG 18	FAZ-C1,5/2-RT	102199	1/40
2	440	15	480Y/277	10	SWD	AWG 18	FAZ-C2/2-RT	102200	1/40
3	440	15	480Y/277	10	SWD	AWG 18	FAZ-C3/2-RT	102201	1/40
4	440	15	480Y/277	10	SWD	AWG 18	FAZ-C4/2-RT	102202	1/40
5	440	15	480Y/277	10	SWD	AWG 18	FAZ-C5/2-RT	102203	1/40
6	440	15	480Y/277	10	SWD	AWG 18	FAZ-C6/2-RT	102204	1/40
7	440	15	480Y/277	10	SWD	AWG 18	FAZ-C7/2-RT	102205	1/40
8	440	15	480Y/277	10	SWD	AWG 16	FAZ-C8/2-RT	102206	1/40
10	440	15	480Y/277	10	SWD	AWG 16	FAZ-C10/2-RT	102207	1/40
13	440	15	480Y/277	10	SWD		FAZ-C13/2-RT	102208	1/40
15	440	15	480Y/277	14	SWD		FAZ-C15/2-RT	102209	1/40
16	440	15	480Y/277	14	SWD		FAZ-C16/2-RT	102210	1/40
20	440	15	480Y/277	14	SWD		FAZ-C20/2-RT	102211	1/40
25	440	15	480Y/277	14			FAZ-C25/2-RT	102212	1/40
30	440	15	480Y/277	10			FAZ-C30/2-RT	102213	1/40
32	440	15	480Y/277	10			FAZ-C32/2-RT	102214	1/40
35	440	15	240	10			FAZ-C35/2-RT	102215	1/40
40	440	15	240	10			FAZ-C40/2-RT	102216	1/40
50	415	15	240	10			FAZ-C50/2-RT	190801	1/40
63	415	15	240	10			FAZ-C63/2-RT	190802	1/40

SG56712



Rated current I_n (A)	Rated voltage acc. to IEC/EN 60947-2 (V)	Breaking capacity acc. to IEC/EN 60947-2 (kA)	Rated voltage acc. to UL489 (V)	Breaking capacity acc. to UL489 (kA)	SWD	NFPA 79	Type Designation	Article No.	Units per package
----------------------------	--	--	--	--	-----	---------	---------------------	-------------	----------------------

SGS7012



3-poles

0.5	440	15	480Y/277	10	SWD	AWG 18	FAZ-C0,5/3-RT	102277	1/28
1	440	15	480Y/277	10	SWD	AWG 18	FAZ-C1/3-RT	102278	1/28
1,5	440	15	480Y/277	10	SWD	AWG 18	FAZ-C1,5/3-RT	102279	1/28
2	440	15	480Y/277	10	SWD	AWG 18	FAZ-C2/3-RT	102280	1/28
3	440	15	480Y/277	10	SWD	AWG 18	FAZ-C3/3-RT	102281	1/28
4	440	15	480Y/277	10	SWD	AWG 18	FAZ-C4/3-RT	102282	1/28
5	440	15	480Y/277	10	SWD	AWG 18	FAZ-C5/3-RT	102283	1/28
6	440	15	480Y/277	10	SWD	AWG 18	FAZ-C6/3-RT	102284	1/28
7	440	15	480Y/277	10	SWD	AWG 18	FAZ-C7/3-RT	102285	1/28
8	440	15	480Y/277	10	SWD	AWG 16	FAZ-C8/3-RT	102286	1/28
10	440	15	480Y/277	10	SWD	AWG 16	FAZ-C10/3-RT	102287	1/28
13	440	15	480Y/277	10	SWD		FAZ-C13/3-RT	102288	1/28
15	440	15	480Y/277	14	SWD		FAZ-C15/3-RT	102289	1/28
16	440	15	480Y/277	14	SWD		FAZ-C16/3-RT	102290	1/28
20	440	15	480Y/277	14	SWD		FAZ-C20/3-RT	102291	1/28
25	440	15	480Y/277	14			FAZ-C25/3-RT	102292	1/28
30	440	15	480Y/277	10			FAZ-C30/3-RT	102293	1/28
32	440	15	480Y/277	10			FAZ-C32/3-RT	102294	1/28
35	440	15	240	10			FAZ-C35/3-RT	102295	1/28
40	440	15	240	10			FAZ-C40/3-RT	102296	1/28
50	415	15	240	10			FAZ-C50/3-RT	190807	1/28
63	415	15	240	10			FAZ-C63/3-RT	190808	1/28

wa_sg01017



4-poles

0.5	440	15	480Y/277	10		AWG18	FAZ-C0,5/4-RT	190863	1/20
1	440	15	480Y/277	10		AWG18	FAZ-C1/4-RT	190864	1/20
1,5	440	15	480Y/277	10		AWG18	FAZ-C1,5/4-RT	190865	1/20
2	440	15	480Y/277	10		AWG18	FAZ-C2/4-RT	190866	1/20
3	440	15	480Y/277	10		AWG18	FAZ-C3/4-RT	190867	1/20
4	440	15	480Y/277	10		AWG18	FAZ-C4/4-RT	190868	1/20
5	440	15	480Y/277	10		AWG18	FAZ-C5/4-RT	190869	1/20
6	440	15	480Y/277	10		AWG18	FAZ-C6/4-RT	190870	1/20
7	440	15	480Y/277	10		AWG18	FAZ-C7/4-RT	190871	1/20
8	440	15	480Y/277	10		AWG16	FAZ-C8/4-RT	190872	1/20
10	440	15	480Y/277	10		AWG16	FAZ-C10/4-RT	190873	1/20
13	440	15	480Y/277	10			FAZ-C13/4-RT	190874	1/20
15	440	15	480Y/277	14			FAZ-C15/4-RT	190875	1/20
16	440	15	480Y/277	14			FAZ-C16/4-RT	190876	1/20
20	440	15	480Y/277	14			FAZ-C20/4-RT	190877	1/20
25	440	15	480Y/277	14			FAZ-C25/4-RT	190878	1/20
30	440	15	480Y/277	10			FAZ-C30/4-RT	190879	1/20
32	440	15	480Y/277	10			FAZ-C32/4-RT	190880	1/20
35	440	15	240	10			FAZ-C35/4-RT	190881	1/20
40	440	15	240	10			FAZ-C40/4-RT	190882	1/20
50	415	15	240	10			FAZ-C50/4-RT	190809	1/20
63	415	15	240	10			FAZ-C63/4-RT	190810	1/20

2.250 Miniature Circuit Breakers

FAZ-...-RT Miniature Circuit Breakers

Rated current I_n (A)	Rated voltage acc. to IEC/EN 60947-2 (V)	Breaking capacity acc. to IEC/EN 60947-2 (kA)	Rated voltage acc. to UL489 (V)	Breaking capacity acc. to UL489 (kA)	SWD	NFPA 79	Type Designation	Article No.	Units per package
----------------------------	--	--	--	--	-----	---------	---------------------	-------------	----------------------

Characteristic D

SG56412



1-pole

0.5	240	15	277	10	SWD	AWG 18	FAZ-D0,5/1-RT	102137	2/80
1	240	15	277	10	SWD	AWG 18	FAZ-D1/1-RT	102138	2/80
1,5	240	15	277	10	SWD	AWG 18	FAZ-D1,5/1-RT	102139	2/80
2	240	15	277	10	SWD	AWG 18	FAZ-D2/1-RT	102140	2/80
3	240	15	277	10	SWD	AWG 18	FAZ-D3/1-RT	102141	2/80
4	240	15	277	10	SWD	AWG 18	FAZ-D4/1-RT	102142	2/80
5	240	15	277	10	SWD	AWG 18	FAZ-D5/1-RT	102143	2/80
6	240	15	277	10	SWD	AWG 18	FAZ-D6/1-RT	102144	2/80
7	240	15	277	10	SWD	AWG 18	FAZ-D7/1-RT	102145	2/80
8	240	15	277	10	SWD	AWG 16	FAZ-D8/1-RT	102146	2/80
10	240	15	277	10	SWD	AWG 16	FAZ-D10/1-RT	102147	2/80
13	240	15	277	14	SWD		FAZ-D13/1-RT	102148	2/80
15	240	15	277	14	SWD		FAZ-D15/1-RT	102149	2/80
16	240	15	277	14	SWD		FAZ-D16/1-RT	102150	2/80
20	240	15	277	14	SWD		FAZ-D20/1-RT	102151	2/80
25	240	15	277	10			FAZ-D25/1-RT	102152	2/80
30	240	15	277	10			FAZ-D30/1-RT	102153	2/80
32	240	15	277	10			FAZ-D32/1-RT	102154	2/80
35	240	15	240	10			FAZ-D35/1-RT	102155	2/80
40	240	15	240	10			FAZ-D40/1-RT	102156	2/80

SG56712



2-poles

0.5	415	15	480Y/277	10	SWD	AWG 18	FAZ-D0,5/2-RT	102217	1/40
1	415	15	480Y/277	10	SWD	AWG 18	FAZ-D1/2-RT	102218	1/40
1,5	415	15	480Y/277	10	SWD	AWG 18	FAZ-D1,5/2-RT	102219	1/40
2	415	15	480Y/277	10	SWD	AWG 18	FAZ-D2/2-RT	102220	1/40
3	415	15	480Y/277	10	SWD	AWG 18	FAZ-D3/2-RT	102221	1/40
4	415	15	480Y/277	10	SWD	AWG 18	FAZ-D4/2-RT	102222	1/40
5	415	15	480Y/277	10	SWD	AWG 18	FAZ-D5/2-RT	102223	1/40
6	415	15	480Y/277	10	SWD	AWG 18	FAZ-D6/2-RT	102224	1/40
7	415	15	480Y/277	10	SWD	AWG 18	FAZ-D7/2-RT	102225	1/40
8	415	15	480Y/277	10	SWD	AWG 16	FAZ-D8/2-RT	102226	1/40
10	415	15	480Y/277	10	SWD	AWG 16	FAZ-D10/2-RT	102227	1/40
13	415	15	480Y/277	14	SWD		FAZ-D13/2-RT	102228	1/40
15	415	15	480Y/277	14	SWD		FAZ-D15/2-RT	102229	1/40
16	415	15	480Y/277	14	SWD		FAZ-D16/2-RT	102230	1/40
20	415	15	480Y/277	14	SWD		FAZ-D20/2-RT	102231	1/40
25	415	15	480Y/277	10			FAZ-D25/2-RT	102232	1/40
30	415	15	480Y/277	10			FAZ-D30/2-RT	102233	1/40
32	415	15	480Y/277	10			FAZ-D32/2-RT	102234	1/40
35	415	15	240	10			FAZ-D35/2-RT	102235	1/40
40	415	15	240	10			FAZ-D40/2-RT	102236	1/40

Rated current I_n (A)	Rated voltage acc. to IEC/EN 60947-2 (V)	Breaking capacity acc. to IEC/EN 60947-2 (kA)	Rated voltage acc. to UL489 (V)	Breaking capacity acc. to UL489 (kA)	SWD	NFPA 79	Type Designation	Article No.	Units per package
3-poles									
0.5	415	15	480Y/277	10	SWD	AWG 18	FAZ-D0,5/3-RT	102297	1/28
1	415	15	480Y/277	10	SWD	AWG 18	FAZ-D1/3-RT	102298	1/28
1,5	415	15	480Y/277	10	SWD	AWG 18	FAZ-D1,5/3-RT	102299	1/28
2	415	15	480Y/277	10	SWD	AWG 18	FAZ-D2/3-RT	102300	1/28
3	415	15	480Y/277	10	SWD	AWG 18	FAZ-D3/3-RT	102301	1/28
4	415	15	480Y/277	10	SWD	AWG 18	FAZ-D4/3-RT	102302	1/28
5	415	15	480Y/277	10	SWD	AWG 18	FAZ-D5/3-RT	102303	1/28
6	415	15	480Y/277	10	SWD	AWG 18	FAZ-D6/3-RT	102304	1/28
7	415	15	480Y/277	10	SWD	AWG 18	FAZ-D7/3-RT	102305	1/28
8	415	15	480Y/277	10	SWD	AWG 16	FAZ-D8/3-RT	102306	1/28
10	415	15	480Y/277	10	SWD	AWG 16	FAZ-D10/3-RT	102307	1/28
13	415	15	480Y/277	14	SWD		FAZ-D13/3-RT	102308	1/28
15	415	15	480Y/277	14	SWD		FAZ-D15/3-RT	102309	1/28
16	415	15	480Y/277	14	SWD		FAZ-D16/3-RT	102310	1/28
20	415	15	480Y/277	14	SWD		FAZ-D20/3-RT	102311	1/28
25	415	15	480Y/277	10			FAZ-D25/3-RT	102312	1/28
30	415	15	480Y/277	10			FAZ-D30/3-RT	102313	1/28
32	415	15	480Y/277	10			FAZ-D32/3-RT	102314	1/28
35	415	15	240	10			FAZ-D35/3-RT	102315	1/28
40	415	15	240	10			FAZ-D40/3-RT	102316	1/28

SGS7012



4-poles									
0.5	415	15	480Y/277	10		AWG18	FAZ-D0,5/4-RT	190883	1/20
1	415	15	480Y/277	10		AWG18	FAZ-D1/4-RT	190884	1/20
1,5	415	15	480Y/277	10		AWG18	FAZ-D1,5/4-RT	190885	1/20
2	415	15	480Y/277	10		AWG18	FAZ-D2/4-RT	190886	1/20
3	415	15	480Y/277	10		AWG18	FAZ-D3/4-RT	190887	1/20
4	415	15	480Y/277	10		AWG18	FAZ-D4/4-RT	190888	1/20
5	415	15	480Y/277	10		AWG18	FAZ-D5/4-RT	190889	1/20
6	415	15	480Y/277	10		AWG18	FAZ-D6/4-RT	190890	1/20
7	415	15	480Y/277	10		AWG18	FAZ-D7/4-RT	190891	1/20
8	415	15	480Y/277	10		AWG16	FAZ-D8/4-RT	190892	1/20
10	415	15	480Y/277	10		AWG16	FAZ-D10/4-RT	190893	1/20
13	415	15	480Y/277	10			FAZ-D13/4-RT	190894	1/20
15	415	15	480Y/277	14			FAZ-D15/4-RT	190895	1/20
16	415	15	480Y/277	14			FAZ-D16/4-RT	190896	1/20
20	415	15	480Y/277	14			FAZ-D20/4-RT	190897	1/20
25	415	15	480Y/277	14			FAZ-D25/4-RT	190898	1/20
30	415	15	480Y/277	10			FAZ-D30/4-RT	190811	1/20
32	415	15	480Y/277	10			FAZ-D32/4-RT	190812	1/20
35	415	15	240	10			FAZ-D35/4-RT	190813	1/20
40	415	15	240	10			FAZ-D40/4-RT	190814	1/20

wa_sg01017



Miniature Circuit Breakers FAZ-...-NA, -RT

Accessories:

Auxiliary switch for subsequent installation	Z-IHK-NA	113895
Tripping signal contact for subsequent installation	Z-NHK	248434
Shunt trip release	FAZ-XAA-NA12-110V AC	102037
	FAZ-XAA-NA110-415V AC	102036
Switching interlock	Z-IS/SPE-1TE	274418

Technical Data IEC/EN

	FAZ-...-NA, -RT	
Productstandard	IEC/EN 60947-2	
Classified according to	IEC 61373, EN 45545-2	
Current test marks as printed onto the device		
Number of poles	1, 2, 3, 4	
Mechanical		
Device width	17.7 mm (1-pole), 35.4 mm (2-poles), 53.1 mm (3-poles), 70.8 mm (4-poles)	
Frame size	45 mm	
Device height	105 mm	
Device depth	60 mm	
Terminals	lift terminal / ring-tongue	
Terminal capacity rigid solid/stranded wire	1-25 mm ²	
Terminal screw	M5 (with slotted screw Pozidriv PZ2)	
Fastening torque of terminal screws	max. 2.4 Nm	
Degree of protection (DIN VDE 0470)		
Surface mounted	IP20	
Built-in behind panel	IP40	
Contact position indicator	red / green	
Electrical		
Rated voltage	U_n	Only characteristic B, C (up to 40 A): 254/440 V AC For characteristic B, C (50 and 63 A) and characteristic D: 240/415 V AC
Rated current	I_n	0.5, 1, 1.5, 2, 3, 4, 5, 6, 7, 8, 10, 13, 15, 16, 20, 25, 30, 32, 35, 40, 50, 63 A
Rated insulation voltage	U_i	440 V AC
Rated impulse withstand voltage	U_{imp}	4 kV (1.2/50) μ sec
Tripping characteristic		
Conventional non-tripping current	$I_{nt} = 1.05 I_n$	
Conventional tripping current	$I_t = 1.30 I_n$	
Reference temperature	30 °C	
Temperature factor	0.5%/K	
Instantaneous tripping current	I_{mt}	Type B: $3 I_n < I_{mt} = 5 I_n \cdot t (I_{mt}) < 0.1 \text{ sec}$ Type C: $5 I_n < I_{mt} = 10 I_n \cdot t (I_{mt}) < 0.1 \text{ sec}$ Type D: $10 I_n < I_{mt} = 20 I_n \cdot t (I_{mt}) < 0.1 \text{ sec}$
Rated short-circuit breaking capacity	I_{cu}	15 kA
Service short circuit capacity	I_{cs}	7.5 kA
Selectivity class	3 (acc. to EN 60898)	
Number of electrical operations	> 1,500	
Number of mechanical operations	> 10,000	
Climatic conditions	acc. to IEC 60068-2-30 (25..55°C / 90..95% RH)	
Operating temperature range	-40°C up to +75°C	
Storage- and transport temperature	-40°C up to +75°C	
Operating utility frequency	50/60 Hz	

Connection diagram

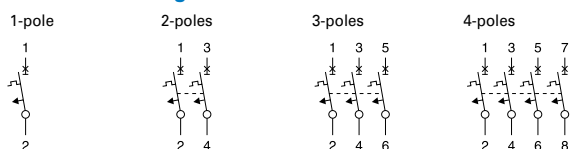

Technical Data UL

		FAZ-...-NA, -RT
Productstandard		UL 489, CSA C22.2 No. 5-02
Number of poles		1, 2, 3, 4
Mechanical		
Device width		0.697 in. (1-pole), 1.394 in. (2-poles), 2.090 in. (3-poles), 2.788 in. (4-poles)
Frame size		1.772 in.
Device height		4.134 in.
Device depth		2.362 in.
Terminals		lift terminal / ring-tongue
Terminal capacity rigid solid/stranded wire		1 Wire: #18-6 AWG (Cu only) 2 Wires: #18-10 AWG (Cu only)
Terminal screw		M5 (with slotted screw Pozidriv PZ2)
Fastening torque of terminal screws		#18-12 AWG: 2.4 Nm (21 lb-in) #10-8 AWG: 2.8 Nm (25 lb-in) #6 AWG: 4 Nm (36 lb-in)
Contact position indicator		red / green
Electrical		
Rated voltage	U_n	0.5-32 A: 480Y/277 V AC, 35-63 A: 240 V AC
Rated current	I_n	0.5, 1, 1.5, 2, 3, 4, 5, 6, 7, 8, 10, 13, 15, 16, 20, 25, 30, 32, 35, 40, 50 (not D), 63 (not D) A
Tripping characteristic		
Conventional non-tripping current		$I_{nt} = 1,00 I_n$
Conventional tripping current		$I_t = 1.35 I_n$
Reference temperature		25 °C
Temperature factor		0.5%/K
Instantaneous tripping current	I_{mt}	Type B: $3 I_n < I_{mt} = 5 I_n \cdot t (I_{mt}) < 0.1 \text{ sec}$ Type C: $5 I_n < I_{mt} = 10 I_n \cdot t (I_{mt}) < 0.1 \text{ sec}$ Type D: $10 I_n < I_{mt} = 20 I_n \cdot t (I_{mt}) < 0.1 \text{ sec}$
Current interrupting rating		
10 kA		B0.5-13A, B30-63A, C0.5-13A, C30-63A, D0.5-10A, D25-40A
14 kA		B15-25A, C15-25A, D13-20A
Current-Limiting		
High interrupt current at 240 V / 10 kA		$I^2t = 42 \text{ kA}^2\text{s}$ and $I_{peak} = 6.2 \text{ kA}$
Intermediate interrupt current at 240 V / 5 kA		$I^2t = 24 \text{ kA}^2\text{s}$ and $I_{peak} = 4.2 \text{ kA}$
Threshold current at 240 V / 2.6 kA		$I^2t = 18 \text{ kA}^2\text{s}$ and $I_{peak} = 2.9 \text{ kA}$
High interrupt current at 480Y/277V / 10 kA		$I^2t = 60 \text{ kA}^2\text{s}$ and $I_{peak} = 6.2 \text{ kA}$
High interrupt current at 480Y/277V / 14 kA		$I^2t = 65 \text{ kA}^2\text{s}$ and $I_{peak} = 7.5 \text{ kA}$
Intermediate interrupt current at 480Y/277V / 5 kA		$I^2t = 36 \text{ kA}^2\text{s}$ and $I_{peak} = 4.6 \text{ kA}$
Threshold current at 480Y/277V / 2.08 kA		$I^2t = 15 \text{ kA}^2\text{s}$ and $I_{peak} = 2.2 \text{ kA}$
Selectivity class		3 (acc. to EN 60898)
Number of electrical operations		6,000
Number of mechanical operations		10,000
Climatic conditions		acc. to IEC 60068-2-30 (25..55°C / 90..95% RH)
Operating temperature range		-5°C up to +40 °C
Storage- and transport temperature		-40°C up to +75°C
Operating utility frequency		50/60 Hz (B, C, D up to 40 A) 60 Hz (50, 63 A)

Connection diagram

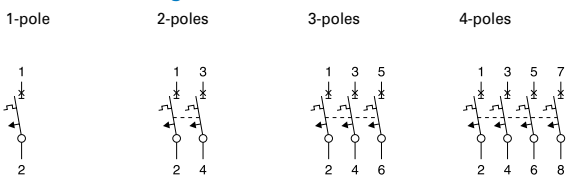

Connection of ring cable lugs (only FAZ...RT)

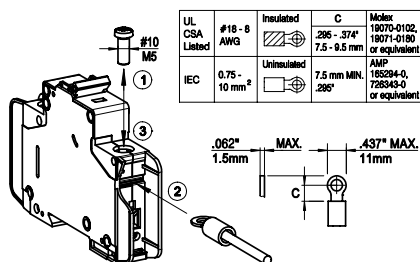

Dimensions (mm) FAZ-...-NA, -RT

1-pole

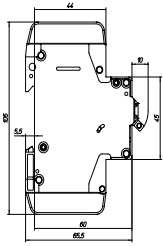
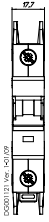

2-poles

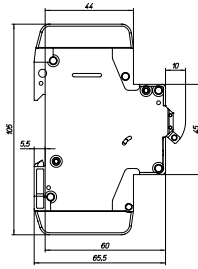
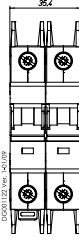

3-poles

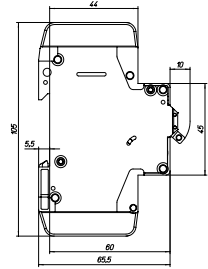
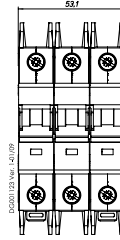

4-poles

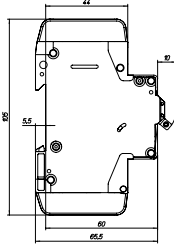
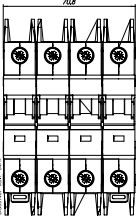

Tripping Characteristics FAZ-...-NA, -RT

Characteristics C and D - EN/IEC 60947-2

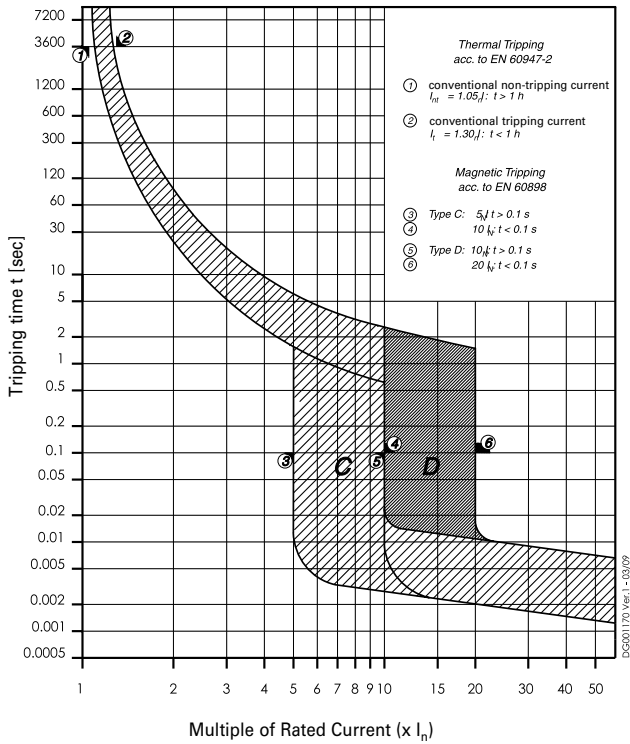

Characteristics B, C and D - UL 489

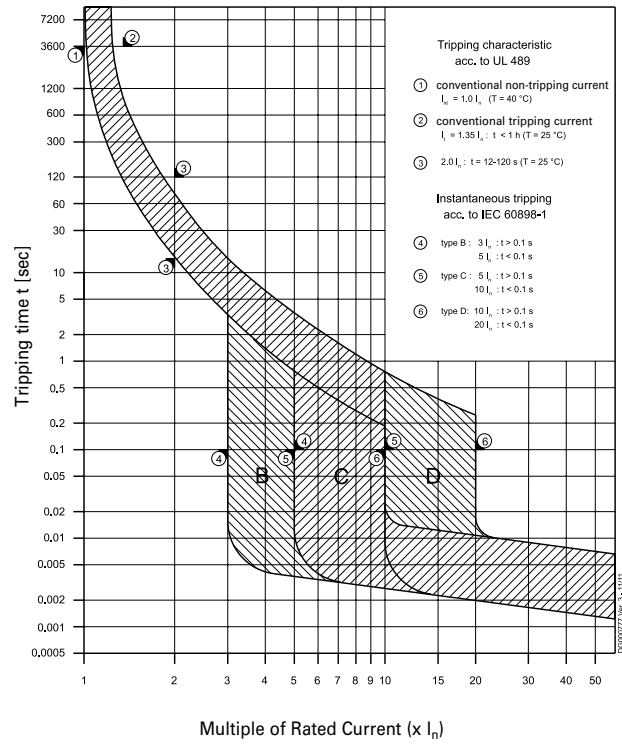

Internal Resistance FAZ-...-NA, -RT (50/60Hz)

Type B	
At room temperature (single pole)	
I_n [A]	R^* [mΩ]
1	1100
1.5	900
2	350
3	220
4	87
5	72
6	47
7	38
8	30
10	17
13	13
15	8.0
16	8.0
20	6.9
25	3.9
30	2.8
32	3.0
35	2.9
40	1.9
50	1.6
63	1.2
* 50 Hz	

Type C	
At room temperature (single pole)	
I_n [A]	R^* [mΩ]
1	1100
1.5	580
2	350
3	130
4	87
5	60
6	32
7	28
8	19
10	14
13	13
15	8.0
16	8.0
20	6.9
25	3.9
30	2.8
32	3.0
35	2.5
40	1.9
50	1.6
63	1.2
* 50 Hz	

Type D	
At room temperature (single pole)	
I_n [A]	R^* [mΩ]
1	800
1.5	490
2	260
3	130
4	87
5	58
6	32
7	28
8	19
10	14
13	11
15	8.0
16	8.0
20	4.9
25	3.5
30	2.5
32	2.6
35	2.5
40	1.8
50	1.7
63	1.2
* 50 Hz	

Power Loss at I_n FAZ-...-NA, -RT

Type B				
I_n [A]	1p	2p	3p	4p
	P [W]	P [W]	P [W]	P [W]
1	1.2	2.2	3.6	4.8
1.5	2.2	4.4	6.6	8.8
2	1.4	2.8	4.2	5.6
3	2.2	4.4	6.6	8.8
4	1.4	2.8	4.2	5.6
5	1.9	3.8	5.7	7.6
6	1.8	3.6	5.4	7.2
7	2	4	6	8
8	2.1	4.2	6.3	8.4
10	1.8	3.6	5.4	7.2
13	2.5	5	7.5	10
15	2	4	6	8
16	2.3	4.6	6.9	9.2
20	3.3	6.6	9.9	13.2
25	2.8	5.6	8.4	11.2
30	3	6	9	12
32	3.5	7	10.5	14
35	4	8	12	16
40	3.4	6.8	10.2	13.6
50	4.4	8.8	13.2	17.6
63	5.5	11	16.5	22
* 50/60 Hz				

Type C				
I_n [A]	1p	2p	3p	4p
	P [W]	P [W]	P [W]	P [W]
1	1.2	2.4	3.6	4.8
1.5	1.3	2.6	3.9	5.2
2	1.4	2.8	4.2	5.6
3	1.2	2.4	3.6	4.8
4	1.5	3	4.5	6
5	1.6	3.2	4.8	6.4
6	1.2	2.4	3.6	4.8
7	1.4	2.8	4.2	5.6
8	1.3	2.6	3.9	5.2
10	1.5	3	4.5	6
13	2.5	5	7.5	10
15	2	4	6	8
16	2.3	4.6	6.9	9.2
20	3.3	6.6	9.9	13.2
25	2.8	5.6	8.4	11.2
30	3	6	9	12
32	3.5	7	10.5	14
35	3.7	7.4	11.1	14.8
40	3.4	6.8	10.2	13.6
50	4.4	8.8	13.2	17.6
63	5.5	11	16.5	22
* 50/60 Hz				

Type D				
I_n [A]	1p	2p	3p	4p
	P [W]	P [W]	P [W]	P [W]
1	0.8	1.6	2.4	3.2
1.5	1.1	2.2	3.3	4.4
2	1.1	2.2	3.3	4.8
3	1.2	2.4	3.6	4.8
4	1.5	3	4.5	6
5	1.5	3	5.5	6
6	1.2	2.4	3.6	4.8
7	1.4	2.8	4.2	5.6
8	1.3	2.6	3.9	5.2
10	1.5	3	4.5	6
13	2	4	6	8
15	2	4	6	8
16	2.3	4.6	6.9	9.2
20	2.2	4.4	6.6	8.8
25	2.5	5	7.5	10
30	2.7	5.4	8.1	10.8
32	3	6	9	12
35	3.8	7.6	11.4	15.2
40	3.1	6.2	9.3	12.4
50	4.9	9.8	14.7	19.6
63	5.5	11	16.5	22
* 50/60 Hz				

Maximum Let-Through Energy FAZ-...-NA, -RT

Type C (0.5 - 32 A), 277 V

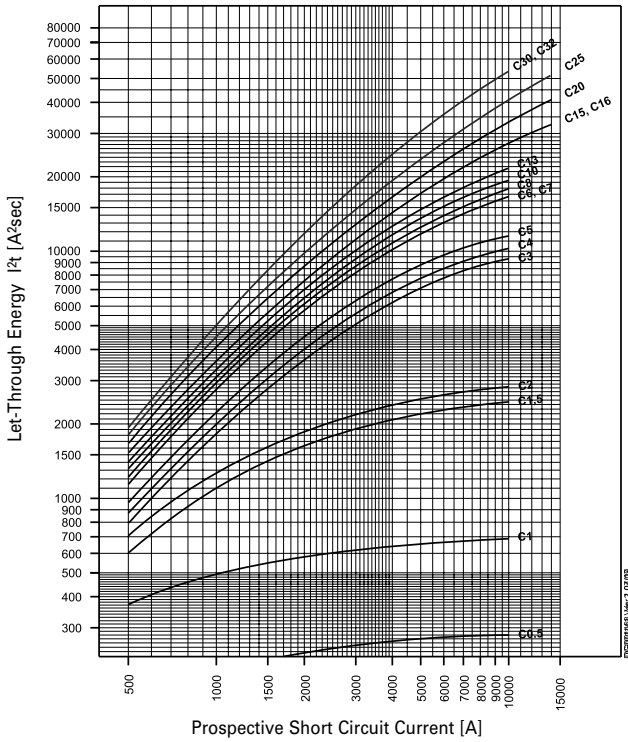

Type C (35 - 40 A), 240 V

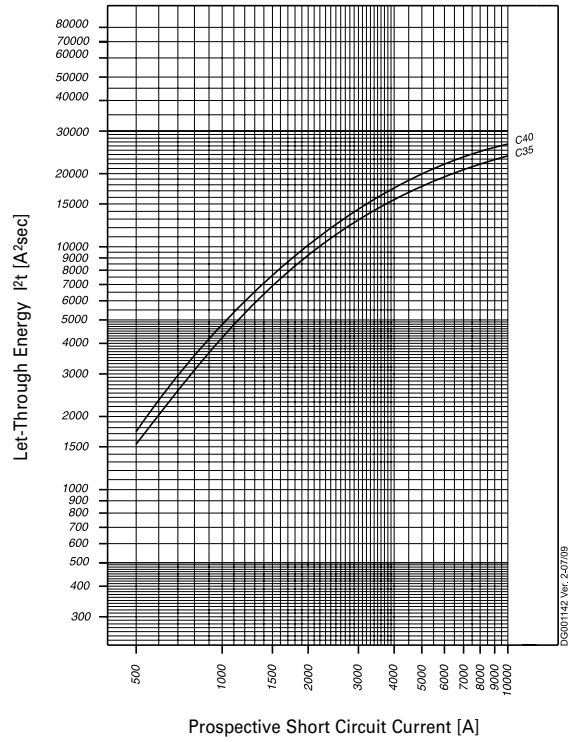

Type D (0.5 - 32 A), 277 V

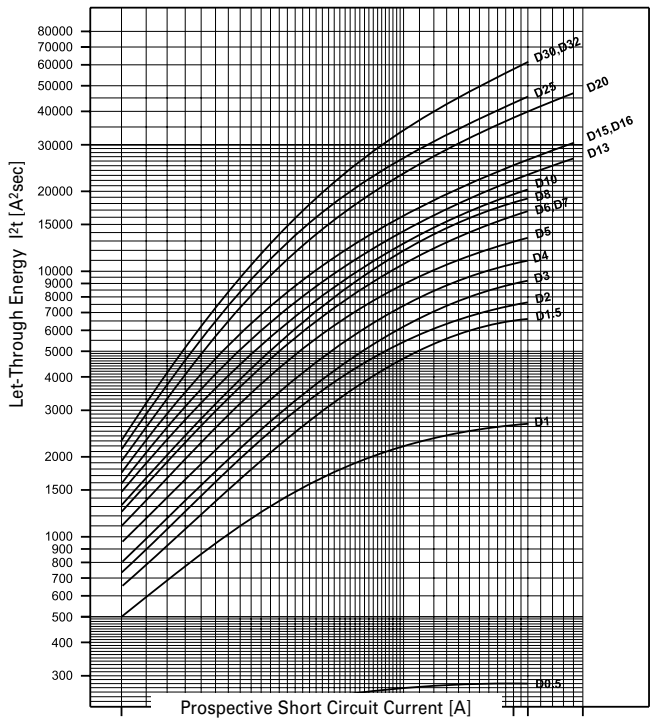

Type D (35 - 40 A), 240 V

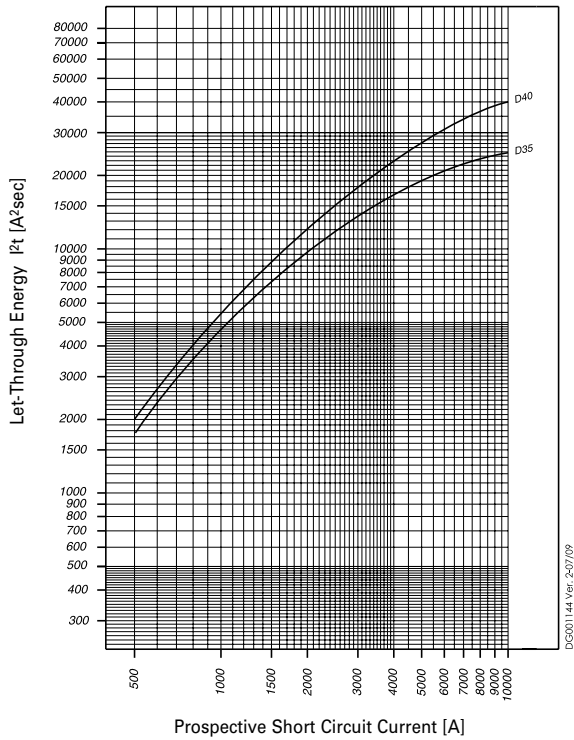

Maximum Let-Through Current FAZ-...-NA, -RT

Type C (0.5 - 32 A), 277 V

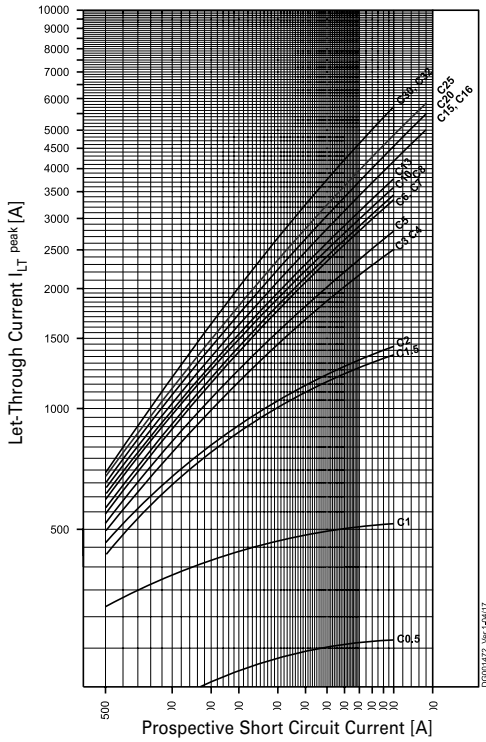

Type C (35 - 40 A), 240 V

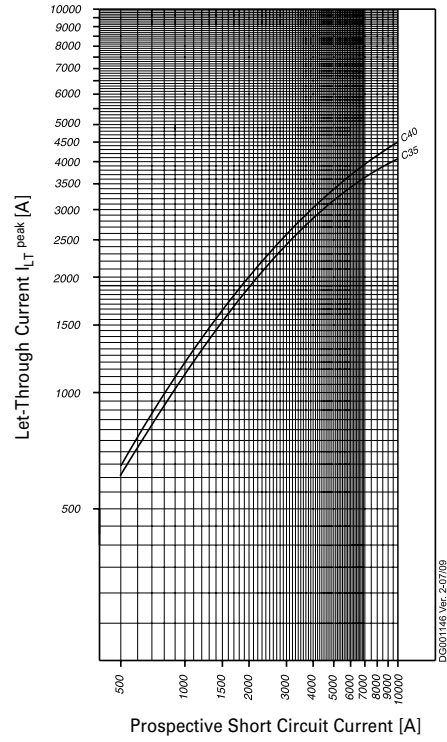

Type D (0.5 - 32 A), 277 V

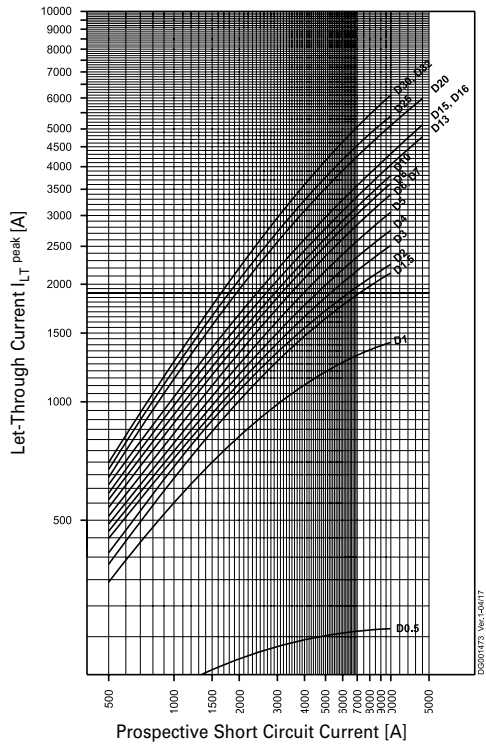

Type D (35 - 40 A), 240 V

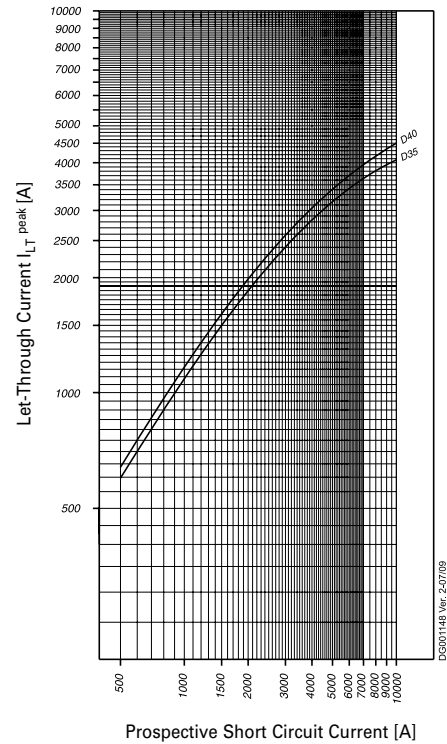

Influence of Ambient Temperature on Load Carrying Capacity (temperature derating)

Values in the table display the nominal current I_n in ampere depending on the ambient temperature

I_n [A]	Ambient Temperature T [°C]										
	-25	-10	5	15	20	25	30	40*	50	55	60
0.5	0.6	0.6	0.6	0.6	0.5	0.5	0.5	0.5	0.5	0.5	0.5
1	1.3	1.2	1.1	1.1	1.1	1.1	1.0	1.0	1.0	0.9	0.9
1.5	1.9	1.8	1.7	1.7	1.6	1.6	1.6	1.5	1.4	1.4	1.4
2	2.5	2.4	2.3	2.2	2.2	2.1	2.1	2.0	1.9	1.9	1.8
3	3.8	3.6	3.4	3.3	3.2	3.2	3.1	3.0	2.9	2.8	2.8
4	5.0	4.8	4.6	4.4	4.3	4.2	4.2	4.0	3.8	3.8	3.7
5	6.3	6.0	5.7	5.5	5.4	5.3	5.2	5.0	4.8	4.7	4.6
6	7.6	7.2	6.8	6.6	6.5	6.4	6.2	6.0	5.8	5.6	5.5
7	8.5	8.0	8.0	7.7	7.6	7.4	7.3	7.0	6.7	6.6	6.4
8	10.1	9.6	9.1	8.8	8.6	8.5	8.3	8.0	7.7	7.5	7.4
10	12.6	12.0	11.4	11.0	10.8	10.6	10.4	10.0	9.6	9.4	9.2
13	16.4	15.6	14.8	14.3	14.0	13.8	13.5	13.0	12.5	12.2	12.0
15	18.9	18.0	17.1	16.5	16.2	15.9	15.6	15.0	14.4	14.1	13.8
16	20.2	19.2	18.2	17.6	17.3	17.0	16.6	16.0	15.4	15.0	14.7
20	25.2	24.0	22.8	22.0	21.6	21.2	20.8	20.0	19.2	18.8	18.4
25	31.5	30.0	28.5	27.5	27.0	26.5	26.0	25.0	24.0	23.5	23.0
30	37.8	36.0	34.2	33.1	32.4	31.8	31.2	30.0	28.8	28.2	27.6
32	40.3	38.4	36.5	35.2	34.6	33.9	33.3	32.0	30.7	30.1	29.4
35	44.1	42.0	39.9	38.5	37.8	37.1	36.4	35.0	33.6	32.9	32.2
40	50.4	48.0	45.6	44.0	43.2	42.4	41.6	40.0	38.4	37.6	36.8
50	63.0	60.0	57.0	55.0	54.0	53.0	52.0	50.0	48.0	47.0	46.0
63	79.4	75.6	71.8	69.3	68.0	66.8	65.5	63.0	60.5	59.2	58.0

*IEC 60947-2, nominal current at reference calibration temperature 40°C

SG56612



Description

FAZ-NA-DC

- High-quality miniature circuit breakers for DC-applications
- Contact position indicator red - green
- Guide for secure terminal connection (not for FAZ-NA)
- 3-position DIN rail clip, permits removal from existing busbar system
- Comprehensive range of accessories suitable for subsequent installation
- Rated currents up to 40 A
- Tripping characteristic C
- Rated breaking capacity 10 kA according to IEC/EN 60947-2
- Up to 125 V DC per pole
- Classified for the use in rail rolling stock

2.260 Miniature Circuit Breakers

FAZ-...-NA-DC Miniature Circuit Breakers

Rated current I_n (A)	Rated voltage acc. to IEC/EN 60947-2 (V)	Breaking capacity acc. to IEC/EN 60947-2 (kA)	Rated voltage acc. to UL489 (V)	Breaking capacity acc. to UL489 (kA)	SWD	NFPA 79	Type Designation	Article No.	Units per package
----------------------------	--	--	--	--	-----	---------	---------------------	-------------	----------------------

Characteristic C

SG56612



1-pole

2	220	10	125	10			FAZ-C2/1-NA-DC	113752	12/120
3	250	10	125	10			FAZ-C3/1-NA-DC	113753	12/120
4	250	10	125	10			FAZ-C4/1-NA-DC	113754	12/120
5	250	10	125	10			FAZ-C5/1-NA-DC	113755	12/120
6	250	10	125	10			FAZ-C6/1-NA-DC	113756	12/120
7	250	10	125	10			FAZ-C7/1-NA-DC	113757	12/120
8	250	10	125	10			FAZ-C8/1-NA-DC	113758	12/120
10	250	10	125	10			FAZ-C10/1-NA-DC	113759	12/120
13	250	10	125	10			FAZ-C13/1-NA-DC	113760	12/120
15	250	10	125	10			FAZ-C15/1-NA-DC	113761	12/120
16	250	10	125	10			FAZ-C16/1-NA-DC	113762	12/120
20	250	10	125	10			FAZ-C20/1-NA-DC	113763	12/120
25	250	10	125	10			FAZ-C25/1-NA-DC	113764	12/120
30	250	10	125	10			FAZ-C30/1-NA-DC	113765	12/120
32	250	10	125	10			FAZ-C32/1-NA-DC	113766	12/120
35	250	10	125	10			FAZ-C35/1-NA-DC	113767	12/120
40	250	10	125	10			FAZ-C40/1-NA-DC	113768	12/120

SG56612



2-poles

2	440	10	250	10			FAZ-C2/2-NA-DC	137239	1/60
3	500	10	250	10			FAZ-C3/2-NA-DC	137250	1/60
4	500	10	250	10			FAZ-C4/2-NA-DC	137251	1/60
5	500	10	250	10			FAZ-C5/2-NA-DC	137252	1/60
6	500	10	250	10			FAZ-C6/2-NA-DC	120638	1/60
7	500	10	250	10			FAZ-C7/2-NA-DC	120639	1/60
8	500	10	250	10			FAZ-C8/2-NA-DC	120640	1/60
10	500	10	250	10			FAZ-C10/2-NA-DC	120641	1/60
13	500	10	250	10			FAZ-C13/2-NA-DC	120642	1/60
15	500	10	250	10			FAZ-C15/2-NA-DC	120643	1/60
16	500	10	250	10			FAZ-C16/2-NA-DC	120644	1/60
20	500	10	250	10			FAZ-C20/2-NA-DC	120645	1/60
25	500	10	250	10			FAZ-C25/2-NA-DC	120646	1/60
30	500	10	250	10			FAZ-C30/2-NA-DC	120647	1/60
32	500	10	250	10			FAZ-C32/2-NA-DC	120648	1/60
35	500	10	250	10			FAZ-C35/2-NA-DC	120649	1/60
40	500	10	250	10			FAZ-C40/2-NA-DC	120650	1/60

Technical Data

		FAZ-...-NA-DC
Productstandard		UL 489, CSA C22.2 No. 5-02
Classified according to		IEC 61373, EN 45545-2
Current test marks as printed onto the device		
Number of poles		1, 2
Mechanical		
Device width		1 pole = 0.697 inch, 2 poles = 1.394 inch
Frame size		1.772 inch
Device height		4.134 inch
Device depth		2.362 inch
Terminals		lift terminal / ring-tongue
Terminal capacity rigid solid/stranded wire		1 Wire: #18-6 AWG (Cu only) 2 Wires: #18-10 AWG (Cu only)
Terminal screw		M5 (with slotted screw Pozidriv PZ2)
Fastening torque of terminal screws		#18-12 AWG: 2.4 Nm (21 lb-in) #10-8 AWG: 2.8 Nm (25 lb-in) #6 AWG: 4 Nm (36 lb-in)
Snap on fixing		tristable (on DIN Rail according to IEC/EN 60715)
Finger proof		acc. to VBG4, ÖVE EN-6
Contact position indicator		red / green
Electrical		
Rated voltage	U_n	125 V DC (1p) 250 V DC (2p)
Rated current	I_n	2, 3, 4, 5, 6, 7, 8, 10, 13, 15, 16, 20, 25, 30, 32, 35, 40 A
Rated impulse withstand voltage	U_{imp}	4 kV (1.2/50) μ sec
Tripping characteristic		
Conventional non-tripping current	I_{nt}	$I_{nt} = 1,00 I_n$
Conventional tripping current	I_t	$I_t = 1.35 I_n$
Reference temperature		25 °C
Temperature factor		0.5%/K
Instantaneous tripping current	I_{mt}	$7 I_n < I_{mt} = 15 I_n \cdot t (I_{mt}) < 0.1 \text{ sec}$
Current interrupting rating		10 kA
Number of electrical operations		6,000
Number of mechanical operations		10,000
Climatic conditions		acc. to IEC 60068-2-30 (25..55°C / 90..95% RH)
Operating temperature range		-25°C up to +55°C

Connection diagram

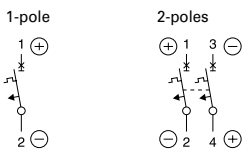

Dimensions (mm) FAZ-...-NA-DC

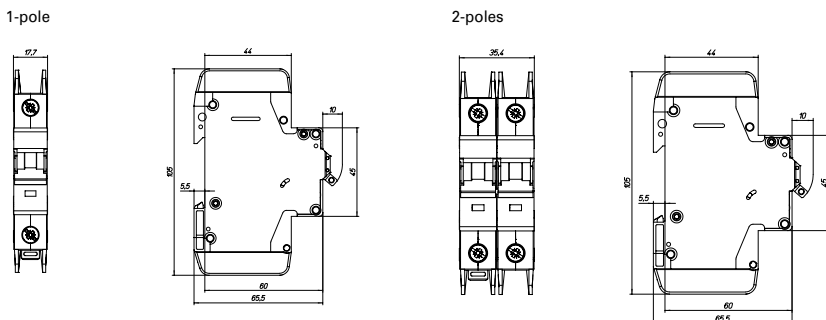

Tripping Characteristics FAZ-...-NA-DC

Characteristics C - UL 489

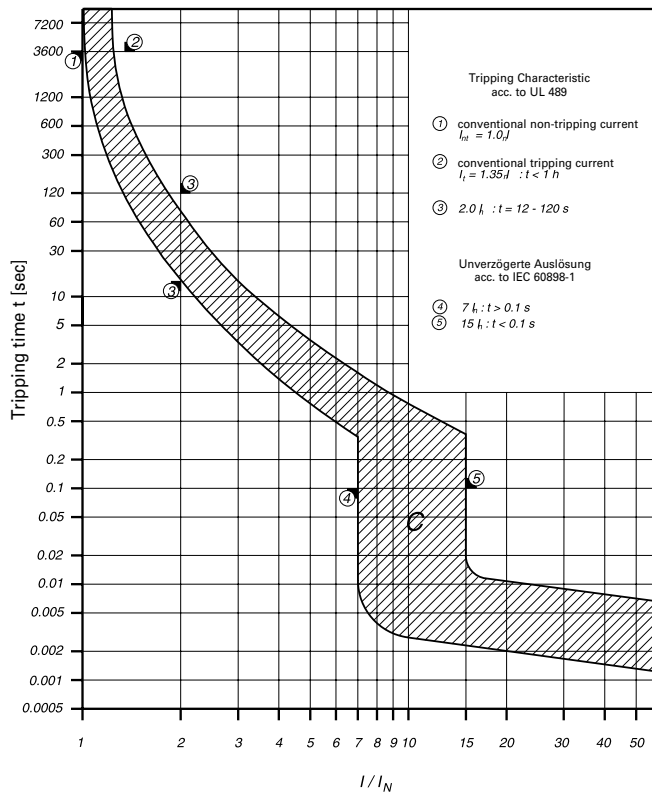

SG56612



Description

FAZ-...-RT-DC

- According to IEC 60947-2 standard
- Auxiliary switch and voltage trips suitable for subsequent installation
- With removable terminal screws for use with ring cable lug
- Contact position indicator red - green
- Easy mounting at DIN-rail
- Classified for the use in rail rolling stock

Rated current I_n (A)	Rated voltage acc. to IEC/EN 60947-2 (V)	Breaking capacity acc. to IEC/EN 60947-2 (kA)	Rated voltage acc. to UL489 (V)	Breaking capacity acc. to UL489 (kA)	SWD	NFPA 79	Type Designation	Article No.	Units per package
----------------------------	--	--	--	--	-----	---------	---------------------	-------------	----------------------

Characteristic B

SG56412



1-pole

2	220	10	-	-	-	-	FAZ-B2/1-RT-DC	305912	2/80
3	250	10	-	-	-	-	FAZ-B3/1-RT-DC	305913	2/80
4	250	10	-	-	-	-	FAZ-B4/1-RT-DC	305914	2/80
5	250	10	-	-	-	-	FAZ-B5/1-RT-DC	305915	2/80
6	250	10	-	-	-	-	FAZ-B6/1-RT-DC	305916	2/80
7	250	10	-	-	-	-	FAZ-B7/1-RT-DC	305917	2/80
8	250	10	-	-	-	-	FAZ-B8/1-RT-DC	305918	2/80
10	250	10	-	-	-	-	FAZ-B10/1-RT-DC	305919	2/80
13	250	10	-	-	-	-	FAZ-B13/1-RT-DC	305920	2/80
15	250	10	-	-	-	-	FAZ-B15/1-RT-DC	305921	2/80
16	250	10	-	-	-	-	FAZ-B16/1-RT-DC	305922	2/80
20	250	10	-	-	-	-	FAZ-B20/1-RT-DC	305923	2/80
25	250	10	-	-	-	-	FAZ-B25/1-RT-DC	305924	2/80
30	250	10	-	-	-	-	FAZ-B30/1-RT-DC	305925	2/80
32	250	10	-	-	-	-	FAZ-B32/1-RT-DC	305927	2/80
35	250	10	-	-	-	-	FAZ-B35/1-RT-DC	305928	2/80
40	250	10	-	-	-	-	FAZ-B40/1-RT-DC	305929	2/80
50	250	10	-	-	-	-	FAZ-B50/1-RT-DC	305930	2/80

SG56712



2-poles

2	220	10	-	-	-	-	FAZ-B2/2-RT-DC	305931	1/40
3	250	10	-	-	-	-	FAZ-B3/2-RT-DC	305932	1/40
4	250	10	-	-	-	-	FAZ-B4/2-RT-DC	305933	1/40
5	250	10	-	-	-	-	FAZ-B5/2-RT-DC	305934	1/40
6	250	10	-	-	-	-	FAZ-B6/2-RT-DC	305935	1/40
7	250	10	-	-	-	-	FAZ-B7/2-RT-DC	305936	1/40
8	250	10	-	-	-	-	FAZ-B8/2-RT-DC	305938	1/40
10	250	10	-	-	-	-	FAZ-B10/2-RT-DC	305939	1/40
13	250	10	-	-	-	-	FAZ-B13/2-RT-DC	305940	1/40
15	250	10	-	-	-	-	FAZ-B15/2-RT-DC	305942	1/40
16	250	10	-	-	-	-	FAZ-B16/2-RT-DC	305943	1/40
20	250	10	-	-	-	-	FAZ-B20/2-RT-DC	305944	1/40
25	250	10	-	-	-	-	FAZ-B25/2-RT-DC	305945	1/40
30	250	10	-	-	-	-	FAZ-B30/2-RT-DC	305946	1/40
32	250	10	-	-	-	-	FAZ-B32/2-RT-DC	305947	1/40
35	250	10	-	-	-	-	FAZ-B35/2-RT-DC	305948	1/40
40	250	10	-	-	-	-	FAZ-B40/2-RT-DC	305949	1/40
50	250	10	-	-	-	-	FAZ-B50/2-RT-DC	305950	1/40

Rated current I_n (A)	Rated voltage acc. to IEC/EN 60947-2 (V)	Breaking capacity acc. to IEC/EN 60947-2 (kA)	Rated voltage acc. to UL489 (V)	Breaking capacity acc. to UL489 (kA)	SWD	NFPA 79	Type Designation	Article No.	Units per package
----------------------------	--	--	--	--	-----	---------	---------------------	-------------	----------------------

Characteristic C

SG56412



1-pole

2	220	10	-	-	-	-	FAZ-C2/1-RT-DC	305869	2/80
3	250	10	-	-	-	-	FAZ-C3/1-RT-DC	305870	2/80
4	250	10	-	-	-	-	FAZ-C4/1-RT-DC	305871	2/80
5	250	10	-	-	-	-	FAZ-C5/1-RT-DC	305872	2/80
6	250	10	-	-	-	-	FAZ-C6/1-RT-DC	305873	2/80
7	250	10	-	-	-	-	FAZ-C7/1-RT-DC	305874	2/80
8	250	10	-	-	-	-	FAZ-C8/1-RT-DC	305875	2/80
10	250	10	-	-	-	-	FAZ-C10/1-RT-DC	305876	2/80
13	250	10	-	-	-	-	FAZ-C13/1-RT-DC	305877	2/80
15	250	10	-	-	-	-	FAZ-C15/1-RT-DC	305878	2/80
16	250	10	-	-	-	-	FAZ-C16/1-RT-DC	305879	2/80
20	250	10	-	-	-	-	FAZ-C20/1-RT-DC	305880	2/80
25	250	10	-	-	-	-	FAZ-C25/1-RT-DC	305881	2/80
30	250	10	-	-	-	-	FAZ-C30/1-RT-DC	305882	2/80
32	250	10	-	-	-	-	FAZ-C32/1-RT-DC	305883	2/80
35	250	10	-	-	-	-	FAZ-C35/1-RT-DC	305884	2/80
40	250	10	-	-	-	-	FAZ-C40/1-RT-DC	305885	2/80
50	250	10	-	-	-	-	FAZ-C50/1-RT-DC	305886	2/80

SG56712



2-poles

2	220	10	-	-	-	-	FAZ-C2/2-RT-DC	305891	1/40
3	250	10	-	-	-	-	FAZ-C3/2-RT-DC	305892	1/40
4	250	10	-	-	-	-	FAZ-C4/2-RT-DC	305894	1/40
5	250	10	-	-	-	-	FAZ-C5/2-RT-DC	305895	1/40
6	250	10	-	-	-	-	FAZ-C6/2-RT-DC	305896	1/40
7	250	10	-	-	-	-	FAZ-C7/2-RT-DC	305897	1/40
8	250	10	-	-	-	-	FAZ-C8/2-RT-DC	305900	1/40
10	250	10	-	-	-	-	FAZ-C10/2-RT-DC	305901	1/40
13	250	10	-	-	-	-	FAZ-C13/2-RT-DC	305902	1/40
15	250	10	-	-	-	-	FAZ-C15/2-RT-DC	305903	1/40
16	250	10	-	-	-	-	FAZ-C16/2-RT-DC	305904	1/40
20	250	10	-	-	-	-	FAZ-C20/2-RT-DC	305905	1/40
25	250	10	-	-	-	-	FAZ-C25/2-RT-DC	305906	1/40
30	250	10	-	-	-	-	FAZ-C30/2-RT-DC	305907	1/40
32	250	10	-	-	-	-	FAZ-C32/2-RT-DC	305908	1/40
35	250	10	-	-	-	-	FAZ-C35/2-RT-DC	305909	1/40
40	250	10	-	-	-	-	FAZ-C40/2-RT-DC	305910	1/40
50	250	10	-	-	-	-	FAZ-C50/2-RT-DC	305911	1/40

Technical Data

		FAZ-...-RT-DC
Productstandard		IEC/EN 60947-2*)
Classified according to		IEC 61373, EN 45545-2
Current test marks as printed onto the device		
Number of poles		1, 2
Mechanical		
Device width		1 pole = 0.697 inch, 2 poles = 1.394 inch
Frame size		1.772 inch
Device height		4.134 inch
Device depth		2.362 inch
Terminals		lift terminal / ring-tongue
Terminal capacity rigid solid/stranded wire		1-25 mm ²
Terminal screw		M5 (with slotted screw Pozidriv PZ2)
Fastening torque of terminal screws		max. 2.4 Nm
Snap on fixing		tristable (on DIN Rail according to IEC/EN 60715)
Finger proof		acc. to VBG4, ÖVE EN-6
Contact position indicator		red / green
Electrical		
Rated voltage	U_n	2 A Type: 220 V (per poles) 3-50 A Types: 250 V (per poles)
Rated current	I_n	2, 3, 4, 5, 6, 7, 8, 10, 13, 15, 16, 20, 25, 30, 32, 35, 40 A
Rated impulse withstand voltage	U_{imp}	4 kV (1.2/50) μ sec
Tripping characteristic		
Conventional non-tripping current		$I_{nt} = 1.13 I_n$
Conventional tripping current		$I_t = 1.45 I_n$
Reference temperature		30 °C
Temperature factor		0.5%/K
Instantaneous tripping current	I_{mt}	Type B: $4 I_n < I_{mt} = 7 I_n$; $t(I_{mt}) < 0.1$ sec Type C: $7 I_n < I_{mt} = 15 I_n$; $t(I_{mt}) < 0.1$ sec
Current interrupting rating		10 kA
Number of electrical operations		> 4,000
Number of mechanical operations		> 20,000
Climatic conditions		acc. to IEC 60068-2-30 (25..55°C / 90..95% RH)
Operating temperature range		-40°C up to +75°C
Storage- and transport temperature		-40°C up to +75°C

*) not for PV string protection!

Connection diagram

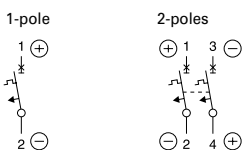

Dimensions (mm) FAZ-...-RT-DC

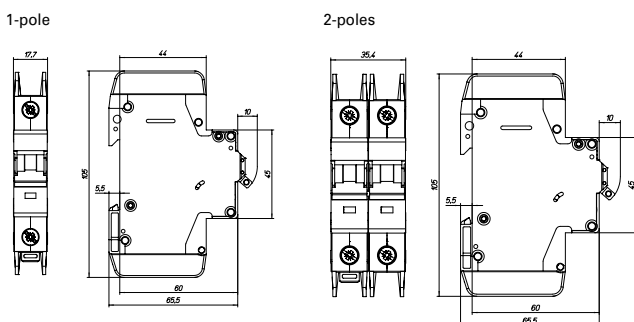

Connection of ring cable lugs (only FAZ...RT)

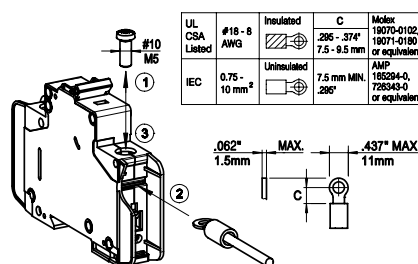

Connection examples FAZ-...-RT-DC

Connection example at 250V=, 1-pole

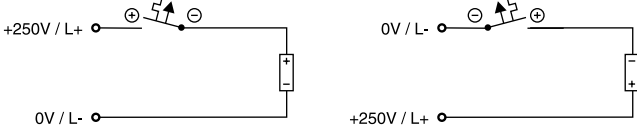

Connection example at 500V=, 2-poles

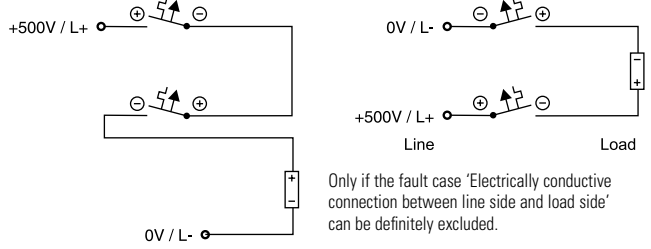

Only if the fault case 'Electrically conductive connection between line side and load side' can be definitely excluded.

Tripping Characteristics FAZ-...-RT-DC

Characteristics C - IEC/EN 60947-2

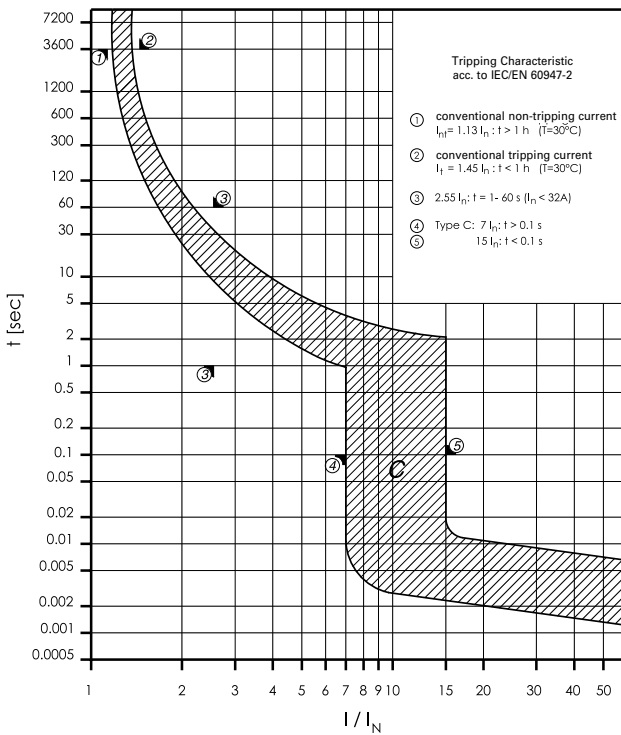

Maximum Let-Through Energy FAZ-...-RT-DC

Type C

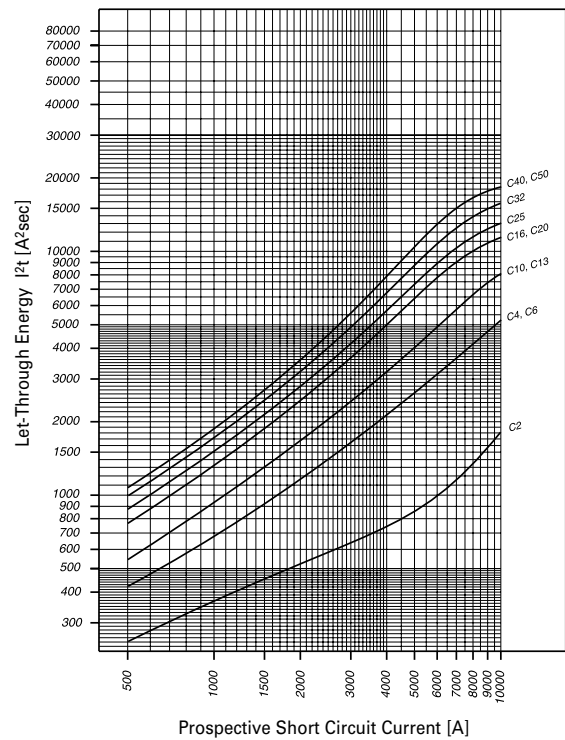

SG08911



Description

- High-quality miniature circuit breakers for industrial applications and residential applications
- Contact position indicator red - green
- Guide for secure terminal connection
- 3-position DIN rail clip, permits removal from existing busbar system
- Comprehensive range of accessories suitable for subsequent installation
- Rated currents up to 63 A
- Tripping characteristics B, C, D

Rated
current
 I_n (A)

Type
Designation

Article No.

Units per
package

Characteristic B

SG11911



1-pole

1	FAZ6-B1/1	177373	12/120
1.5	FAZ6-B1,5/1	177374	12/120
1.6	FAZ6-B1,6/1	177375	12/120
2	FAZ6-B2/1	177376	12/120
2.5	FAZ6-B2,5/1	177377	12/120
3	FAZ6-B3/1	177378	12/120
3.5	FAZ6-B3,5/1	177379	12/120
4	FAZ6-B4/1	177380	12/120
5	FAZ6-B5/1	177381	12/120
6	FAZ6-B6/1	239001	12/120
8	FAZ6-B8/1	177382	12/120
10	FAZ6-B10/1	239006	12/120
12	FAZ6-B12/1	177395	12/120
13	FAZ6-B13/1	239011	12/120
15	FAZ6-B15/1	177396	12/120
16	FAZ6-B16/1	239016	12/120
20	FAZ6-B20/1	239023	12/120
25	FAZ6-B25/1	239024	12/120
32	FAZ6-B32/1	239025	12/120
40	FAZ6-B40/1	239026	12/120
50	FAZ6-B50/1	239027	12/120
63	FAZ6-B63/1	239028	12/120

SG06911



1+N-poles

1	FAZ6-B1/1N	177494	1/60
1.5	FAZ6-B1,5/1N	177495	1/60
1.6	FAZ6-B1,6/1N	177496	1/60
2	FAZ6-B2/1N	177497	1/60
2.5	FAZ6-B2,5/1N	177498	1/60
3	FAZ6-B3/1N	177499	1/60
3.5	FAZ6-B3,5/1N	177500	1/60
4	FAZ6-B4/1N	177501	1/60
5	FAZ6-B5/1N	177502	1/60
6	FAZ6-B6/1N	239044	1/60
8	FAZ6-B8/1N	177503	1/60
10	FAZ6-B10/1N	239045	1/60
12	FAZ6-B12/1N	177504	1/60
13	FAZ6-B13/1N	239046	1/60
15	FAZ6-B15/1N	177505	1/60
16	FAZ6-B16/1N	239047	1/60
20	FAZ6-B20/1N	239048	1/60
25	FAZ6-B25/1N	239049	1/60
32	FAZ6-B32/1N	239050	1/60
40	FAZ6-B40/1N	239051	1/60
50	FAZ6-B50/1N	239052	1/60
63	FAZ6-B63/1N	239053	1/60

2.270 Miniature Circuit Breakers

FAZ6 Miniature Circuit Breakers

Rated
current
 I_n (A)

Type
Designation

Article No.

Units per
package

SG08711



2-poles

1	FAZ6-B1/2	177540	1/60
1.5	FAZ6-B1,5/2	177541	1/60
1.6	FAZ6-B1,6/2	177542	1/60
2	FAZ6-B2/2	177543	1/60
2.5	FAZ6-B2,5/2	177544	1/60
3	FAZ6-B3/2	177545	1/60
3.5	FAZ6-B3,5/2	177546	1/60
4	FAZ6-B4/2	177547	1/60
5	FAZ6-B5/2	177548	1/60
6	FAZ6-B6/2	239085	1/60
8	FAZ6-B8/2	177549	1/60
10	FAZ6-B10/2	239086	1/60
12	FAZ6-B12/2	177550	1/60
13	FAZ6-B13/2	239087	1/60
15	FAZ6-B15/2	177551	1/60
16	FAZ6-B16/2	239088	1/60
20	FAZ6-B20/2	239089	1/60
25	FAZ6-B25/2	239090	1/60
32	FAZ6-B32/2	239091	1/60
40	FAZ6-B40/2	239092	1/60
50	FAZ6-B50/2	239093	1/60
63	FAZ6-B63/2	239094	1/60

SG08811



3-poles

1	FAZ6-B1/3	177577	1/40
1.5	FAZ6-B1,5/3	177578	1/40
1.6	FAZ6-B1,6/3	177579	1/40
2	FAZ6-B2/3	177580	1/40
2.5	FAZ6-B2,5/3	177581	1/40
3	FAZ6-B3/3	177582	1/40
3.5	FAZ6-B3,5/3	177583	1/40
4	FAZ6-B4/3	177584	1/40
5	FAZ6-B5/3	177585	1/40
6	FAZ6-B6/3	239110	1/40
8	FAZ6-B8/3	177586	1/40
10	FAZ6-B10/3	239111	1/40
12	FAZ6-B12/3	177587	1/40
13	FAZ6-B13/3	239112	1/40
15	FAZ6-B15/3	177588	1/40
16	FAZ6-B16/3	239113	1/40
20	FAZ6-B20/3	239114	1/40
25	FAZ6-B25/3	239115	1/40
32	FAZ6-B32/3	239116	1/40
40	FAZ6-B40/3	239117	1/40
50	FAZ6-B50/3	239118	1/40
63	FAZ6-B63/3	239119	1/40

Rated
current
 I_n (A)

Type
Designation

Article No.

Units per
package

SG08911



3+N-poles

1	FAZ6-B1/3N	177446	1/30
1.5	FAZ6-B1,5/3N	177447	1/30
1.6	FAZ6-B1,6/3N	177448	1/30
2	FAZ6-B2/3N	177449	1/30
2.5	FAZ6-B2,5/3N	177450	1/30
3	FAZ6-B3/3N	177451	1/30
3.5	FAZ6-B3,5/3N	177452	1/30
4	FAZ6-B4/3N	177453	1/30
5	FAZ6-B5/3N	177454	1/30
6	FAZ6-B6/3N	239155	1/30
8	FAZ6-B8/3N	177455	1/30
10	FAZ6-B10/3N	239156	1/30
12	FAZ6-B12/3N	177456	1/30
13	FAZ6-B13/3N	239157	1/30
15	FAZ6-B15/3N	177457	1/30
16	FAZ6-B16/3N	239158	1/30
20	FAZ6-B20/3N	239159	1/30
25	FAZ6-B25/3N	239160	1/30
32	FAZ6-B32/3N	239161	1/30
40	FAZ6-B40/3N	239162	1/30
50	FAZ6-B50/3N	239163	1/30
63	FAZ6-B63/3N	239164	1/30

SG12011



4-poles

1	FAZ6-B1/4	177420	1/30
1.5	FAZ6-B1,5/4	177421	1/30
1.6	FAZ6-B1,6/4	177422	1/30
2	FAZ6-B2/4	177423	1/30
2.5	FAZ6-B2,5/4	177424	1/30
3	FAZ6-B3/4	177425	1/30
3.5	FAZ6-B3,5/4	177426	1/30
4	FAZ6-B4/4	177427	1/30
5	FAZ6-B5/4	177428	1/30
6	FAZ6-B6/4	239180	1/30
8	FAZ6-B8/4	177429	1/30
10	FAZ6-B10/4	239181	1/30
12	FAZ6-B12/4	177430	1/30
13	FAZ6-B13/4	239182	1/30
15	FAZ6-B15/4	177431	1/30
16	FAZ6-B16/4	239183	1/30
20	FAZ6-B20/4	239184	1/30
25	FAZ6-B25/4	239185	1/30
32	FAZ6-B32/4	239186	1/30
40	FAZ6-B40/4	239187	1/30
50	FAZ6-B50/4	239188	1/30
63	FAZ6-B63/4	239189	1/30

Rated current I_n (A)	Type Designation	Article No.	Units per package
----------------------------	------------------	-------------	-------------------

Characteristic C

SG11911



1-pole

0.16	FAZ6-C0,16/1	177397	12/120
0.25	FAZ6-C0,25/1	177398	12/120
0.5	FAZ6-C0,5/1	239029	12/120
0.75	FAZ6-C0,75/1	177383	12/120
1	FAZ6-C1/1	239030	12/120
1.5	FAZ6-C1,5/1	177384	12/120
1.6	FAZ6-C1,6/1	177385	12/120
2	FAZ6-C2/1	239031	12/120
2.5	FAZ6-C2,5/1	177386	12/120
3	FAZ6-C3/1	239032	12/120
3.5	FAZ6-C3,5/1	177387	12/120
4	FAZ6-C4/1	239033	12/120
5	FAZ6-C5/1	177388	12/120
6	FAZ6-C6/1	239034	12/120
8	FAZ6-C8/1	177389	12/120
10	FAZ6-C10/1	239035	12/120
12	FAZ6-C12/1	177390	12/120
13	FAZ6-C13/1	239036	12/120
15	FAZ6-C15/1	177391	12/120
16	FAZ6-C16/1	239037	12/120
20	FAZ6-C20/1	239038	12/120
25	FAZ6-C25/1	239039	12/120
32	FAZ6-C32/1	239040	12/120
40	FAZ6-C40/1	239041	12/120
50	FAZ6-C50/1	239042	12/120
63	FAZ6-C63/1	239043	12/120

SG06911



1+N-poles

0.16	FAZ6-C0,16/1N	177506	1/60
0.25	FAZ6-C0,25/1N	177507	1/60
0.5	FAZ6-C0,5/1N	239054	1/60
0.75	FAZ6-C0,75/1N	177508	1/60
1	FAZ6-C1/1N	239055	1/60
1.5	FAZ6-C1,5/1N	177509	1/60
1.6	FAZ6-C1,6/1N	177510	1/60
2	FAZ6-C2/1N	239056	1/60
2.5	FAZ6-C2,5/1N	177511	1/60
3	FAZ6-C3/1N	239057	1/60
3.5	FAZ6-C3,5/1N	177512	1/60
4	FAZ6-C4/1N	239058	1/60
5	FAZ6-C5/1N	177513	1/60
6	FAZ6-C6/1N	239059	1/60
8	FAZ6-C8/1N	177514	1/60
10	FAZ6-C10/1N	239060	1/60
12	FAZ6-C12/1N	177515	1/60
13	FAZ6-C13/1N	239061	1/60
15	FAZ6-C15/1N	177516	1/60
16	FAZ6-C16/1N	239066	1/60
20	FAZ6-C20/1N	239071	1/60
25	FAZ6-C25/1N	239076	1/60
32	FAZ6-C32/1N	239081	1/60
40	FAZ6-C40/1N	239082	1/60
50	FAZ6-C50/1N	239083	1/60
63	FAZ6-C63/1N	239084	1/60

Rated current I_n (A)	Type Designation	Article No.	Units per package
----------------------------	------------------	-------------	-------------------

SG08711



2-poles

0.16	FAZ6-C0,16/2	177552	1/60
0.25	FAZ6-C0,25/2	177553	1/60
0.5	FAZ6-C0,5/2	239095	1/60
0.75	FAZ6-C0,75/2	177554	1/60
1	FAZ6-C1/2	239096	1/60
1.5	FAZ6-C1,5/2	177555	1/60
1.6	FAZ6-C1,6/2	177556	1/60
2	FAZ6-C2/2	239097	1/60
2.5	FAZ6-C2,5/2	177557	1/60
3	FAZ6-C3/2	239098	1/60
3.5	FAZ6-C3,5/2	177558	1/60
4	FAZ6-C4/2	239099	1/60
5	FAZ6-C5/2	177559	1/60
6	FAZ6-C6/2	239100	1/60
8	FAZ6-C8/2	177560	1/60
10	FAZ6-C10/2	239101	1/60
12	FAZ6-C12/2	177561	1/60
13	FAZ6-C13/2	239102	1/60
15	FAZ6-C15/2	177562	1/60
16	FAZ6-C16/2	239103	1/60
20	FAZ6-C20/2	239104	1/60
25	FAZ6-C25/2	239105	1/60
32	FAZ6-C32/2	239106	1/60
40	FAZ6-C40/2	239107	1/60
50	FAZ6-C50/2	239108	1/60
63	FAZ6-C63/2	239109	1/60

SG08811



3-poles

0.16	FAZ6-C0,16/3	177589	1/40
0.25	FAZ6-C0,25/3	177590	1/40
0.5	FAZ6-C0,5/3	239120	1/40
0.75	FAZ6-C0,75/3	177399	1/40
1	FAZ6-C1/3	239121	1/40
1.5	FAZ6-C1,5/3	177400	1/40
1.6	FAZ6-C1,6/3	177401	1/40
2	FAZ6-C2/3	239122	1/40
2.5	FAZ6-C2,5/3	177402	1/40
3	FAZ6-C3/3	239127	1/40
3.5	FAZ6-C3,5/3	177403	1/40
4	FAZ6-C4/3	239132	1/40
5	FAZ6-C5/3	177404	1/40
6	FAZ6-C6/3	239139	1/40
8	FAZ6-C8/3	177405	1/40
10	FAZ6-C10/3	239144	1/40
12	FAZ6-C12/3	177406	1/40
13	FAZ6-C13/3	239147	1/40
15	FAZ6-C15/3	177407	1/40
16	FAZ6-C16/3	239148	1/40
20	FAZ6-C20/3	239149	1/40
25	FAZ6-C25/3	239150	1/40
32	FAZ6-C32/3	239151	1/40
40	FAZ6-C40/3	239152	1/40
50	FAZ6-C50/3	239153	1/40
63	FAZ6-C63/3	239154	1/40

2.274 Miniature Circuit Breakers

xEffect

FAZ6 Miniature Circuit Breakers

Rated current I_n (A)	Type Designation	Article No.	Units per package
----------------------------	------------------	-------------	-------------------

SG08911



3+N-poles

0.16	FAZ6-C0,16/3N	177458	1/30
0.25	FAZ6-C0,25/3N	177459	1/30
0.5	FAZ6-C0,5/3N	239165	1/30
0.75	FAZ6-C0,75/3N	177460	1/30
1	FAZ6-C1/3N	239166	1/30
1.5	FAZ6-C1,5/3N	177461	1/30
1.6	FAZ6-C1,6/3N	177462	1/30
2	FAZ6-C2/3N	239167	1/30
2.5	FAZ6-C2,5/3N	177463	1/30
3	FAZ6-C3/3N	239168	1/30
3.5	FAZ6-C3,5/3N	177464	1/30
4	FAZ6-C4/3N	239169	1/30
5	FAZ6-C5/3N	177465	1/30
6	FAZ6-C6/3N	239170	1/30
8	FAZ6-C8/3N	177466	1/30
10	FAZ6-C10/3N	239171	1/30
12	FAZ6-C12/3N	177467	1/30
13	FAZ6-C13/3N	239172	1/30
15	FAZ6-C15/3N	177468	1/30
16	FAZ6-C16/3N	239173	1/30
20	FAZ6-C20/3N	239174	1/30
25	FAZ6-C25/3N	239175	1/30
32	FAZ6-C32/3N	239176	1/30
40	FAZ6-C40/3N	239177	1/30
50	FAZ6-C50/3N	239178	1/30
63	FAZ6-C63/3N	239179	1/30

SG12011



4-poles

0.16	FAZ6-C0,16/4	177432	1/30
0.25	FAZ6-C0,25/4	177433	1/30
0.5	FAZ6-C0,5/4	239190	1/30
0.75	FAZ6-C0,75/4	177434	1/30
1	FAZ6-C1/4	239191	1/30
1.5	FAZ6-C1,5/4	177591	1/30
1.6	FAZ6-C1,6/4	177592	1/30
2	FAZ6-C2/4	239192	1/30
2.5	FAZ6-C2,5/4	177593	1/30
3	FAZ6-C3/4	239193	1/30
3.5	FAZ6-C3,5/4	177594	1/30
4	FAZ6-C4/4	239194	1/30
5	FAZ6-C5/4	177595	1/30
6	FAZ6-C6/4	239199	1/30
8	FAZ6-C8/4	177596	1/30
10	FAZ6-C10/4	239204	1/30
12	FAZ6-C12/4	177597	1/30
13	FAZ6-C13/4	239211	1/30
15	FAZ6-C15/4	177598	1/30
16	FAZ6-C16/4	239216	1/30
20	FAZ6-C20/4	239219	1/30
25	FAZ6-C25/4	239220	1/30
32	FAZ6-C32/4	239221	1/30
40	FAZ6-C40/4	239222	1/30
50	FAZ6-C50/4	239223	1/30
63	FAZ6-C63/4	239224	1/30

Rated current
 I_n (A)

Type Designation

Article No.

Units per package

Characteristic D

SG11911



1-pole

0.5	FAZ6-D0,5/1	177392	1/120
1	FAZ6-D1/1	177393	1/120
1.5	FAZ6-D1,5/1	177394	1/120
1.6	FAZ6-D1,6/1	177483	1/120
2	FAZ6-D2/1	177484	1/120
2.5	FAZ6-D2,5/1	177485	1/120
3	FAZ6-D3/1	177486	1/120
3.5	FAZ6-D3,5/1	177487	1/120
4	FAZ6-D4/1	177488	1/120
5	FAZ6-D5/1	177489	1/120
6	FAZ6-D6/1	168061	1/120
8	FAZ6-D8/1	177490	1/120
10	FAZ6-D10/1	168062	1/120
12	FAZ6-D12/1	177491	1/120
13	FAZ6-D13/1	177492	1/120
15	FAZ6-D15/1	177493	1/120
16	FAZ6-D16/1	168063	1/120
20	FAZ6-D20/1	168064	1/120
25	FAZ6-D25/1	168065	1/120
32	FAZ6-D32/1	168066	1/120
40	FAZ6-D40/1	168067	1/120
50	FAZ6-D50/1	168068	1/120
63	FAZ6-D63/1	168069	1/120

SG06911



1+N Pole

0.5	FAZ6-D0,5/1N	177517	1/60
1	FAZ6-D1/1N	177518	1/60
1.5	FAZ6-D1,5/1N	177519	1/60
1.6	FAZ6-D1,6/1N	177520	1/60
2	FAZ6-D2/1N	177521	1/60
2.5	FAZ6-D2,5/1N	177522	1/60
3	FAZ6-D3/1N	177523	1/60
3.5	FAZ6-D3,5/1N	177524	1/60
4	FAZ6-D4/1N	177525	1/60
5	FAZ6-D5/1N	177526	1/60
6	FAZ6-D6/1N	177527	1/60
8	FAZ6-D8/1N	177528	1/60
10	FAZ6-D10/1N	177529	1/60
12	FAZ6-D12/1N	177530	1/60
13	FAZ6-D13/1N	177531	1/60
15	FAZ6-D15/1N	177532	1/60
16	FAZ6-D16/1N	177533	1/60
20	FAZ6-D20/1N	177534	1/60
25	FAZ6-D25/1N	177535	1/60
32	FAZ6-D32/1N	177536	1/60
40	FAZ6-D40/1N	177537	1/60
50	FAZ6-D50/1N	177538	1/60
63	FAZ6-D63/1N	177539	1/60

FAZ6 Miniature Circuit Breakers

Rated
current
 I_n (A)Type
Designation

Article No.

Units per
package

SG08711

**2-poles**

0.5	FAZ6-D0,5/2	177563	1/60
1	FAZ6-D1/2	177564	1/60
1.5	FAZ6-D1,5/2	177565	1/60
1.6	FAZ6-D1,6/2	177566	1/60
2	FAZ6-D2/2	177567	1/60
2.5	FAZ6-D2,5/2	177568	1/60
3	FAZ6-D3/2	177569	1/60
3.5	FAZ6-D3,5/2	177570	1/60
4	FAZ6-D4/2	177571	1/60
5	FAZ6-D5/2	177572	1/60
6	FAZ6-D6/2	168070	1/60
8	FAZ6-D8/2	177573	1/60
10	FAZ6-D10/2	168071	1/60
12	FAZ6-D12/2	177574	1/60
13	FAZ6-D13/2	177575	1/60
15	FAZ6-D15/2	177576	1/60
16	FAZ6-D16/2	168072	1/60
20	FAZ6-D20/2	168073	1/60
25	FAZ6-D25/2	168074	1/60
32	FAZ6-D32/2	168075	1/60
40	FAZ6-D40/2	168076	1/60
50	FAZ6-D50/2	168077	1/60
63	FAZ6-D63/2	168078	1/60

SG08811

**3-poles**

0.5	FAZ6-D0,5/3	177408	1/40
1	FAZ6-D1/3	177409	1/40
1.5	FAZ6-D1,5/3	177410	1/40
1.6	FAZ6-D1,6/3	177435	1/40
2	FAZ6-D2/3	177436	1/40
2.5	FAZ6-D2,5/3	177437	1/40
3	FAZ6-D3/3	177438	1/40
3.5	FAZ6-D3,5/3	177439	1/40
4	FAZ6-D4/3	177440	1/40
5	FAZ6-D5/3	177441	1/40
6	FAZ6-D6/3	168079	1/40
8	FAZ6-D8/3	177442	1/40
10	FAZ6-D10/3	168080	1/40
12	FAZ6-D12/3	177443	1/40
13	FAZ6-D13/3	177444	1/40
15	FAZ6-D15/3	177445	1/40
16	FAZ6-D16/3	168081	1/40
20	FAZ6-D20/3	168082	1/40
25	FAZ6-D25/3	168083	1/40
32	FAZ6-D32/3	168084	1/40
40	FAZ6-D40/3	168085	1/40
50	FAZ6-D50/3	168086	1/40
63	FAZ6-D63/3	168087	1/40

Rated current I_n (A)

Type Designation

Article No.

Units per package

SG08911



3+N Pole

0.5	FAZ6-D0,5/3N	177469	1/30
1	FAZ6-D1/3N	177470	1/30
1.5	FAZ6-D1,5/3N	177471	1/30
1.6	FAZ6-D1,6/3N	177472	1/30
2	FAZ6-D2/3N	177473	1/30
2.5	FAZ6-D2,5/3N	177474	1/30
3	FAZ6-D3/3N	177475	1/30
3.5	FAZ6-D3,5/3N	177476	1/30
4	FAZ6-D4/3N	177477	1/30
5	FAZ6-D5/3N	177478	1/30
6	FAZ6-D6/3N	177479	1/30
8	FAZ6-D8/3N	177480	1/30
10	FAZ6-D10/3N	177481	1/30
12	FAZ6-D12/3N	177482	1/30
13	FAZ6-D13/3N	177411	1/30
15	FAZ6-D15/3N	177412	1/30
16	FAZ6-D16/3N	177413	1/30
20	FAZ6-D20/3N	177414	1/30
25	FAZ6-D25/3N	177415	1/30
32	FAZ6-D32/3N	177416	1/30
40	FAZ6-D40/3N	177417	1/30
50	FAZ6-D50/3N	177418	1/30
63	FAZ6-D63/3N	177419	1/30

SG12011



4-poles

0.5	FAZ6-D0,5/4	177599	1/30
1	FAZ6-D1/4	177600	1/30
1.5	FAZ6-D1,5/4	177601	1/30
1.6	FAZ6-D1,6/4	177602	1/30
2	FAZ6-D2/4	177603	1/30
2.5	FAZ6-D2,5/4	177604	1/30
3	FAZ6-D3/4	177605	1/30
3.5	FAZ6-D3,5/4	177606	1/30
4	FAZ6-D4/4	177607	1/30
5	FAZ6-D5/4	177608	1/30
6	FAZ6-D6/4	168088	1/30
8	FAZ6-D8/4	177609	1/30
10	FAZ6-D10/4	168089	1/30
12	FAZ6-D12/4	177610	1/30
13	FAZ6-D13/4	177611	1/30
15	FAZ6-D15/4	177612	1/30
16	FAZ6-D16/4	168090	1/30
20	FAZ6-D20/4	168091	1/30
25	FAZ6-D25/4	168092	1/30
32	FAZ6-D32/4	168093	1/30
40	FAZ6-D40/4	168094	1/30
50	FAZ6-D50/4	168095	1/30
63	FAZ6-D63/4	168096	1/30

Miniature Circuit Breakers FAZ6

Accessories:

Auxiliary switch for subsequent installation	ZP-IHK	286052
	ZP-WHK	286053
Tripping signal contact for subsequent installation	ZP-NHK	248437
Shunt trip release	ZP-ASA/..	248438, 248439
Undervoltage release	Z-USA	258288, 248289, 248290
	Z-USD	248292, 248291

Technical Data

Electrical	B Characteristic	C Characteristic	D Characteristic
Approvals	UR (UL 1077), CSA (CSA 22.2 No. 235), CE, ÖVE, EAC		
Standards	IEC/EN 60947-2, IEC/EN 60898-1		
Short-circuit trip response	3–5 I _n	5–10 I _n	10–20 I _n
Supplementary Protectors-UL/CSA			
Current range	1–63 A	0,16–63 A	0,5–40 A
Maximum voltage ratings - UL/CSA			
Single-pole, single-pole + neutral	277 V AC 48 V DC	277 V AC 48 V DC	277 V AC 48 V DC
Two-, three-, four-pole and three-pole + neutral	480Y/277 V AC	480Y/277 V AC	480Y/277 V AC
Two poles in series	96 V DC	96 V DC	96 V DC
Thermal tripping characteristics			
Single-pole	< 1 hour @ 1.35 x I _n @ 40°C	< 1 hour @ 1.35 x I _n @ 40°C	< 1 hour @ 1.35 x I _n @ 40°C
Multi-pole	< 1 hour @ 1.45 x I _n @ 40°C	< 1 hour @ 1.45 x I _n @ 40°C	< 1 hour @ 1.45 x I _n @ 40°C
Short-circuit ratings (at max. voltage)			
Single-pole	10 kA (5 kA for 40–63A device)	10 kA (5 kA for 40–63A device)	5 kA
Two-, three-pole	10 kA (5 kA for 40–63A device)	10 kA (5 kA for 40–63A device)	5 kA
Single-pole	10 kA @ 48 V DC	10 kA @ 48 V DC	10 kA @ 48 V DC
Two poles in series	10 kA @ 96 V DC	10 kA @ 96 V DC	10 kA @ 96 V DC
Miniature Circuit Breaker - IEC			
Current range	1–63 A	0.16–63 A	0.5–63 A
Maximum voltage ratings - IEC 60947-2			
Single-pole, single-pole + neutral	230 V AC 60 V DC	230 V AC 60 V DC	230 V AC 60 V DC
Two-, three-, four-pole and three-pole + neutral	400 V AC	400 V AC	400 V AC
Maximum voltage ratings - IEC 60898			
Single-pole, single-pole + neutral	240 V AC	240 V AC	240 V AC
Two-, three-, four-pole and three-pole + neutral	415 V AC	415 V AC	415 V AC
Thermal tripping characteristics - IEC 60947-2			
	> 1 hour @ 1.05 x I _n @ 40°C < 1 hour @ 1.3 x I _n @ 40°C	> 1 hour @ 1.05 x I _n @ 40°C < 1 hour @ 1.3 x I _n @ 40°C	> 1 hour @ 1.05 x I _n @ 40°C < 1 hour @ 1.3 x I _n @ 40°C
Interrupt ratings (at max. voltage)			
IEC 60947-2	10 kA	10 kA	10 kA (Type D50 and D63: 10 kA)
IEC 60898	6 kA	6 kA	6 kA (Type D50 und D63: not tested)
Operational switching capacity	7.5 kA	7.5 kA	7.5 kA (Type D50 und D63: 6 kA)
Max. back-up fuse [gL/gG]	100 A	100 A	100 A
Rated impulse withstand voltage - U _{imp}	4000 V AC	4000 V AC	4000 V AC
Rated insulation voltage - U _i	440 V AC	440 V AC	440 V AC
Environmental / General			
Selectivity class	3	3	3
Endurance (operations)	>10000 (1 operation = ON/OFF)	>10000 (1 operation = ON/OFF)	>10000 (1 operation = ON/OFF)
Shock (IEC 68-2-22)	15 g / 20 ms	15 g / 20 ms	15 g / 20 ms
Operating temperature range	-40°C up to +75°C	-40°C up to +75°C	-40°C up to +75°C
Storage- and transport temperature	-40°C up to +75°C	-40°C up to +75°C	-40°C up to +75°C
Mechanical			
Device height	80 mm	80 mm	80 mm
Terminal protection	Finger and back-of-hand proof	Finger and back-of-hand proof	Finger and back-of-hand proof
Mounting width per pole	17.5 mm	17.5 mm	17.5 mm
Mounting	IEC/EN 60715 top-hat rail	IEC/EN 60715 top-hat rail	IEC/EN 60715 top-hat rail
Degree of protection	IP20	IP20	IP20
Terminals top and bottom	Twin-purpose terminals	Twin-purpose terminals	Twin-purpose terminals
Supply connection	Line or load side	Line or load side	Line or load side
Terminal capacity [mm ²]	1 x 25 / 2 x 10	1 x 25 / 2 x 10	1 x 25 / 2 x 10
Torque of terminals	2.4 Nm	2.4 Nm	2.4 Nm
Thickness of busbar material	0.8 - 2 mm	0.8 - 2 mm	0.8 - 2 mm
Mounting position	As required	As required	As required

Connection diagram

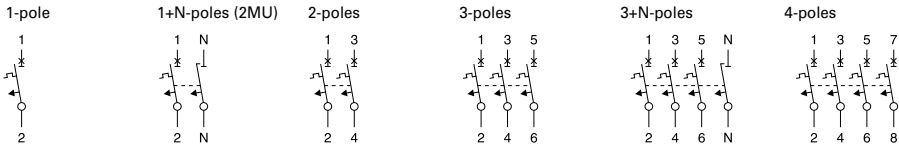

Dimensions (mm) FAZ6

1-pole

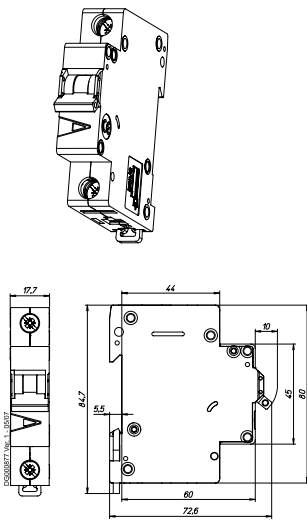

1+N-poles, 2-poles

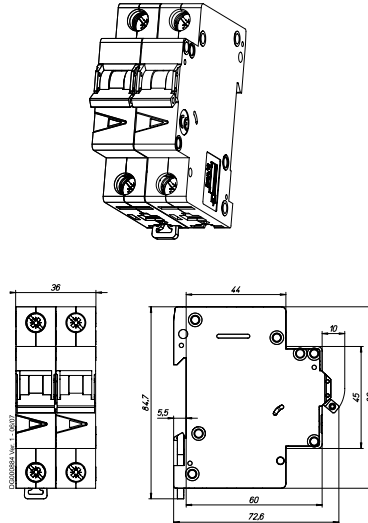

3-poles

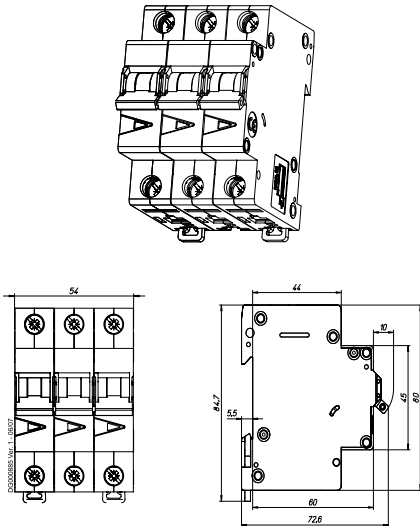

3+N-poles, 4-poles

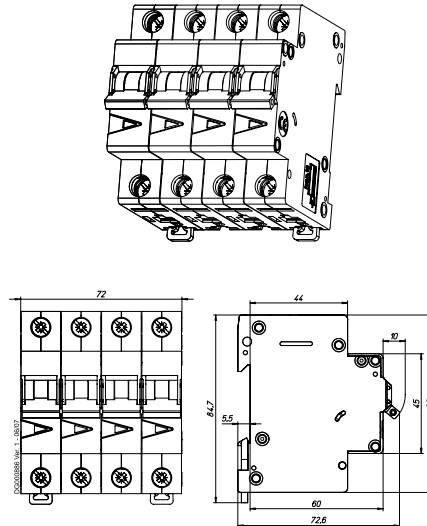

Tripping Characteristics FAZ6

Characteristics B, C and D - IEC 898, EN 60898

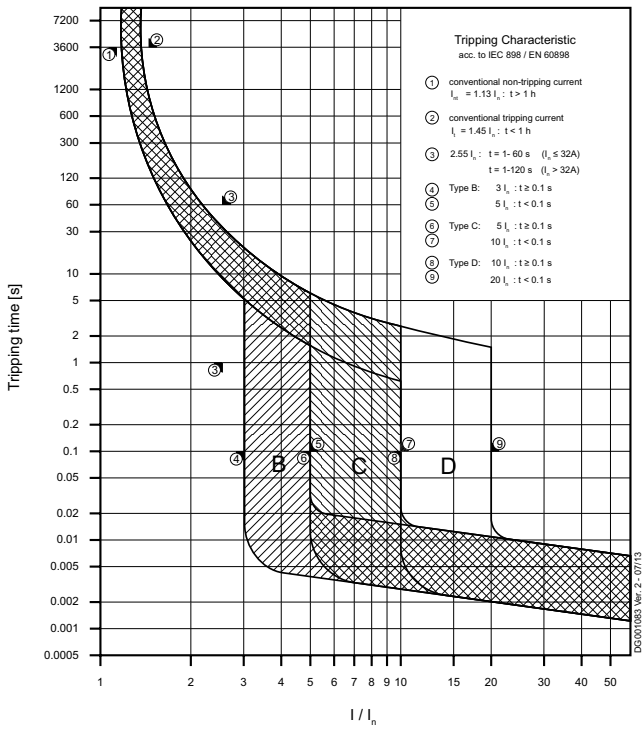

Characteristics B, C and D - IEC 947, EN 60947

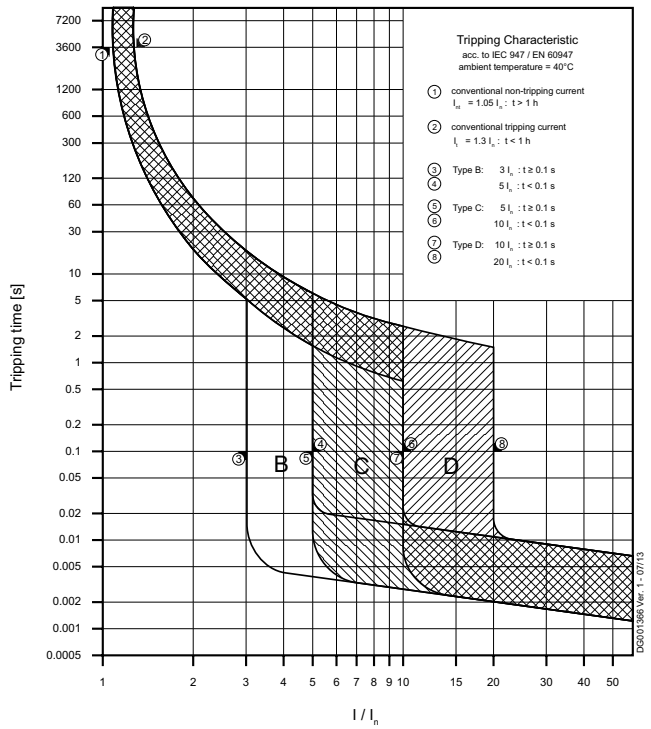

Internal ResistanceFAZ6

Type B

At room temperature (single pole)

I_n [A]	R^* [mΩ]
6	46.8
10	17.5
13	13.4
16	8.0
20	7.2
25	5.0
32	3.7
40	2.6
50	2.1
63	2.0

* 50 Hz

Type C

At room temperature (single pole)

0.5	4680
1	1120
2	335
3	131
4	87.7
6	39.3
10	14.1
13	13.4
16	8.0
20	7.2
25	5.0
32	3.7
40	2.6
50	2.1
63	2.0

* 50 Hz

Type B

At room temperature (single pole)

I_n [A]	R^* [mΩ]
6	39.3
10	14.1
16	8.0
20	4.9
25	3.9
32	3.5
40	2.7
50	1.9
63	1.5

* 50 Hz

Power Loss at I_n FAZ6

Type B					
I_n [A]	1p P* [W]	1pN P* [W]	2p P* [W]	3p P* [W]	3pN P* [W]
6	1.8	2	3.6	5.5	5.6
10	1.9	2.1	3.9	5.9	6.1
13	2.5	2.9	5.3	7.8	8.1
16	2.2	2.6	4.7	6.9	7.2
20	3.2	3.6	6.6	9.8	10.1
25	3	3.5	6.4	9.4	9.7
32	3.7	4.4	8.1	12.1	12.5
40	3.4	4.1	7.5	11.2	11.5
50	4.5	5.4	9.9	14.9	15.3
63	5.2	6.3	11.5	17.2	17.7

* 50/60 Hz

Type C					
I_n [A]	1p P* [W]	1pN P* [W]	2p P* [W]	3p P* [W]	3pN P* [W]
0.5	1.2	1.3	2.4	3.5	3.7
1	1.6	1.7	3.1	4.7	4.8
2	1.4	1.5	2.8	4.1	4.3
3	1.2	1.3	2.4	3.6	3.7
4	1.4	1.6	2.9	4.4	4.5
6	1.5	1.6	2.9	4.4	4.6
10	1.5	1.7	3	4.6	4.7
13	2.5	2.9	5.3	7.8	8.1
16	2.2	2.6	4.7	6.9	7.2
20	3.2	3.6	6.6	9.8	10.1
25	3	3.5	6.4	9.4	9.7
32	3.7	4.4	8.1	12.1	12.5
40	3.4	4.1	7.5	11.2	11.5
50	4.5	5.4	9.9	14.9	15.3
63	5.2	6.3	11.5	17.2	17.7

* 50/60 Hz

Type D					
I_n [A]	1p P* [W]	1pN P* [W]	2p P* [W]	3p P* [W]	3pN P* [W]
6	1.5	1.6	2.9	4.4	4.6
10	1.5	1.7	3	4.6	4.7
16	2.2	2.6	4.7	6.9	7.2
20	2	2.2	4.1	6.8	6.2
25	2.5	2.9	5.2	7.7	7.9
32	3.4	4	7.4	11.1	11.4
40	3.2	3.8	7	10.4	10.7
50	4.9	7.5	9.8	14.6	17.3
63	6.8	11.9	13.6	20.4	25.5

* 50/60 Hz

Influence of Ambient Temperature on Load Carrying Capacity (temperature derating) at I_n IEC 898, FAZ6

Values in the table display the nominal current I_n in ampere depending on the ambient temperature

I _n [A]	Ambient Temperature T [°C]																
	-40	-30	-20	-10	0	10	20	30	35	40	45	50	55	60	65	70	75
0.5	0.64	0.62	0.6	0.58	0.56	0.54	0.52	0.5	0.49	0.48	0.47	0.46	0.45	0.44	0.43	0.42	0.41
1	1.3	1.2	1.2	1.2	1.1	1.1	1	1	0.99	0.97	0.95	0.93	0.9	0.89	0.87	0.85	0.83
2	2.6	2.5	2.4	2.3	2.2	2.2	2.1	2	2	1.9	1.9	1.9	1.8	1.8	1.7	1.7	1.7
3	3.8	3.7	3.6	3.5	3.4	3.3	3.1	3	3	2.9	2.8	2.8	2.7	2.7	2.6	2.5	2.5
4	5.1	5	4.8	4.7	4.5	4.3	4.2	4	3.9	3.9	3.8	3.7	3.6	3.5	3.5	3.4	3.3
6	7.7	7.5	7.2	7	6.7	6.5	6.3	6	5.9	5.8	5.7	5.6	5.4	5.3	5.2	5.1	5
10	10	12	12	12	11	11	10	10	9.9	9.7	9.5	9.3	9	8.9	8.7	8.5	8.3
13	17	16	16	15	15	14	14	13	13	13	12	12	12	12	11	11	11
16	20	20	19	19	18	17	17	16	16	15	15	15	14	14	14	14	13
20	26	25	24	23	22	22	21	20	20	19	19	19	18	18	17	17	17
25	32	31	30	29	28	27	26	25	25	24	24	23	23	22	22	21	21
32	41	40	38	37	36	35	33	32	32	31	30	30	29	28	28	27	26
40	51	50	48	47	45	43	42	40	39	39	38	37	36	35	35	34	33
50	64	62	60	58	56	54	52	50	49	48	47	46	45	44	43	42	41
63	81	78	76	73	71	68	66	63	62	61	60	58	57	56	55	53	52

Influence of Ambient Temperature on Load Carrying Capacity (temperature derating) at I_n IEC 947, FAZ6

Values in the table display the nominal current I_n in ampere depending on the ambient temperature

I _n [A]	Ambient Temperature T [°C]																
	-40	-30	-20	-10	0	10	20	30	35	40	45	50	55	60	65	70	75
0.5	0.68	0.66	0.64	0.62	0.6	0.58	0.56	0.54	0.52	0.5	0.49	0.48	0.47	0.46	0.45	0.44	0.43
1	1.4	1.3	1.3	1.2	1.2	1.2	1.1	1.1	1	1	0.99	0.97	0.95	0.93	0.9	0.89	0.87
2	2.8	2.7	2.6	2.5	2.4	2.3	2.2	2.2	2.1	2	2	1.9	1.9	1.9	1.8	1.8	1.7
3	4	3.9	3.8	3.7	3.6	3.5	3.4	3.3	3.1	3	3	2.9	2.8	2.8	2.7	2.7	2.6
4	5.4	5.3	5.1	5	4.8	4.7	4.5	4.3	4.2	4	3.9	3.9	3.8	3.7	3.6	3.5	3.5
6	8.2	8	7.7	7.5	7.2	7	6.7	6.5	6.3	6	5.9	5.8	5.7	5.6	5.4	5.3	5.2
10	12	11	10	12	12	12	11	11	10	10	9.9	9.7	9.5	9.3	9	8.9	8.7
13	18	17	17	16	16	15	15	14	14	13	13	13	12	12	12	12	11
16	21	21	20	20	19	19	18	17	17	16	16	15	15	15	14	14	14
20	28	27	26	25	24	23	22	22	21	20	20	19	19	19	18	18	17
25	34	33	32	31	30	29	28	27	26	25	25	24	24	23	23	22	22
32	44	42	41	40	38	37	36	35	33	32	32	31	30	30	29	28	28
40	54	53	51	50	48	47	45	43	42	40	39	39	38	37	36	35	35
50	68	66	64	62	60	58	56	54	52	50	49	48	47	46	45	44	43
63	86	83	81	78	76	73	71	68	66	63	62	61	60	58	57	56	55

Maximum Let-Through Energy IEC 947, FAZ6

Let-through energy FAZ6, Characteristic B, 1-pole

230 V / 400 V

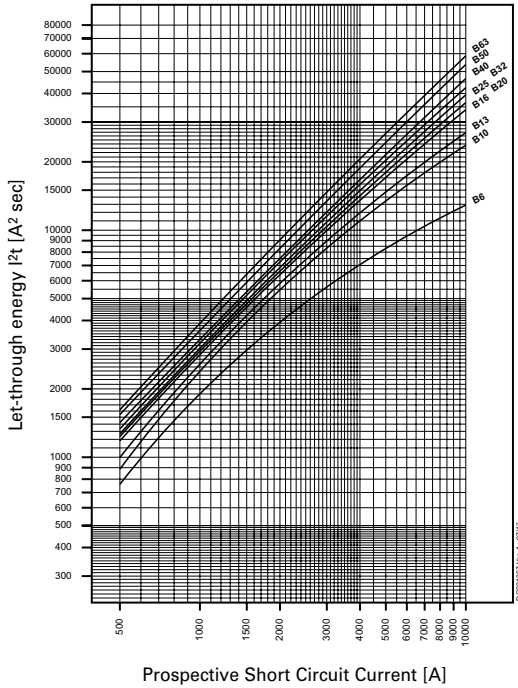

Let-through energy FAZ6, Characteristic C, 1-pole

230 V / 400 V

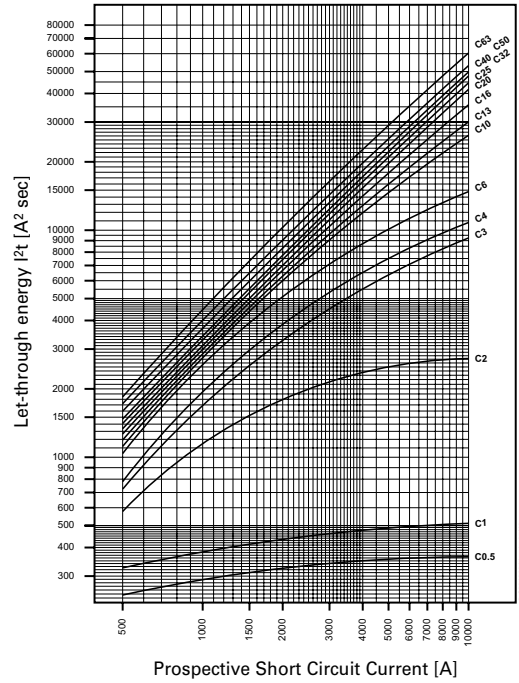

Let-through energy FAZ6, Characteristic D, 1-pole

230 V / 400 V

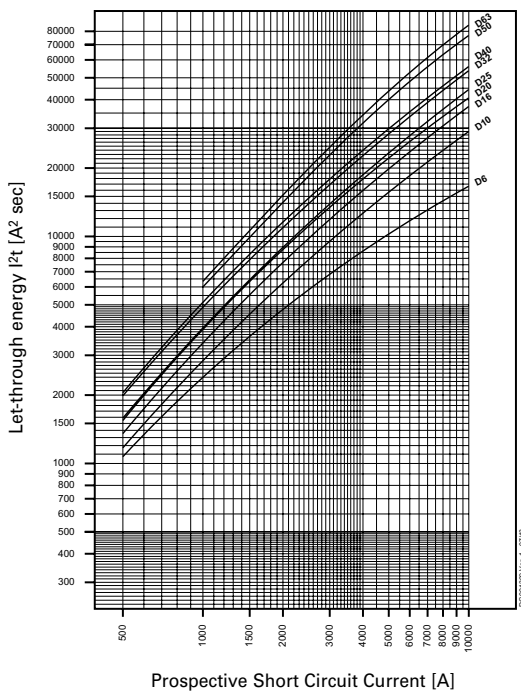

Maximum Let-Through Current IEC 947, FAZ6

Let-through current FAZ6, Characteristic B, 1-pole

230 V / 400 V

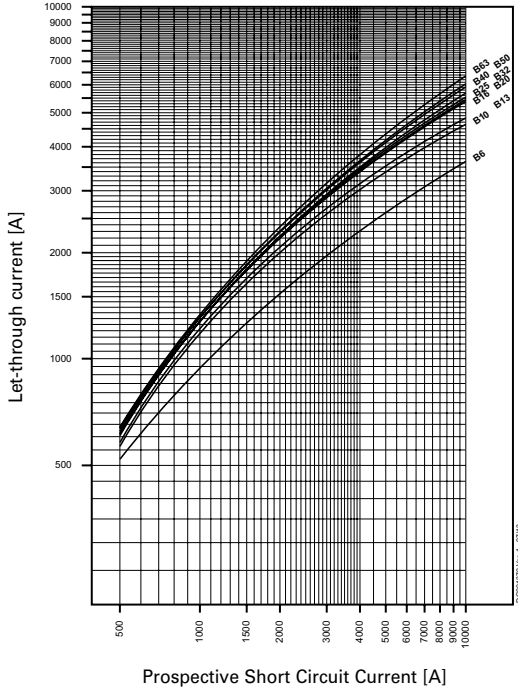

Let-through current FAZ6, Characteristic C, 1-pole

230 V / 400 V

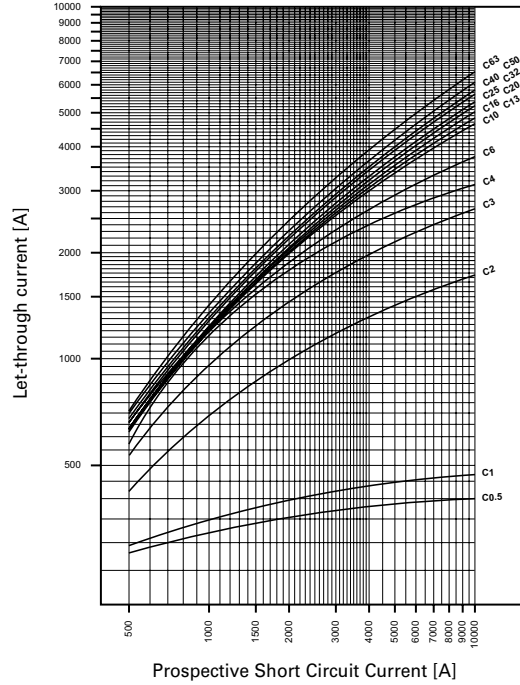

Let-through current FAZ6, Characteristic D, 1-pole

230 V / 400 V

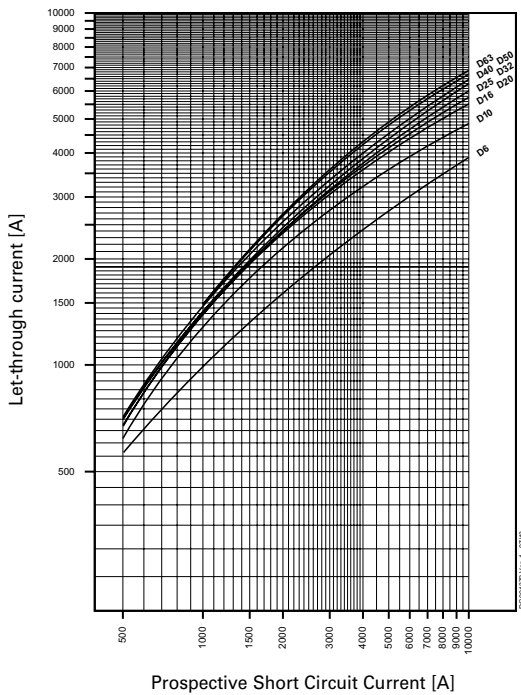

Influence of the Line Frequency FAZ

On the Instantaneous Tripping Current I_{MA}

	Line Frequency f [Hz]						
	16²/₃	50	60	100	200	300	400
$I_{MA}(f)/I_{MA}(50\text{ Hz})$ [%]	91	100	101	106	115	134	141

The use of the products in networks with other frequencies than 50/60 Hz are in the customer's responsibility.

Load Capacity of Series Connected Miniature Circuit Breakers

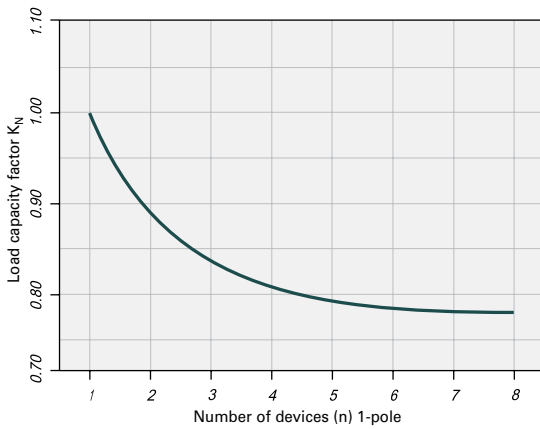

SG51412



Description

- High-quality miniature circuit breakers for industrial and commercial applications
- Contact position indicator red - green
- Accessories suitable for subsequent installation
- Rated currents up to 125 A
- Tripping characteristics B, C, D
- Rated breaking capacity up to 25 kA according to EN 60947-2
- Classified for the use in rail rolling stock

2.288 Miniature Circuit Breakers

AZ Miniature Circuit Breakers

Rated current I_n (A)

Type Designation

Article No.

Units per package

Characteristic B

SG51212



1-pole

20	AZ-B20	174480	12
25	AZ-B25	174481	12
32	AZ-B32	174482	12
40	AZ-B40	174483	12
50	AZ-B50	174484	12
63	AZ-B63	174485	12
80	AZ-B80	174486	12
100	AZ-B100	174487	12
125	AZ-B125	174488	12

SG51312



2-poles

20	AZ-2-B20	174493	6
25	AZ-2-B25	174494	6
32	AZ-2-B32	174495	6
40	AZ-2-B40	174496	6
50	AZ-2-B50	174497	6
63	AZ-2-B63	174498	6
80	AZ-2-B80	174499	6
100	AZ-2-B100	174500	6
125	AZ-2-B125	174501	6

wa_sg00314



3-poles

20	AZ-3-B20	174506	4
25	AZ-3-B25	174507	4
32	AZ-3-B32	174508	4
40	AZ-3-B40	174509	4
50	AZ-3-B50	174510	4
63	AZ-3-B63	174511	4
80	AZ-3-B80	174512	4
100	AZ-3-B100	174513	4
125	AZ-3-B125	174514	4

wa_sg00214



3+N-poles

20	AZ-3N-B20	174519	3
25	AZ-3N-B25	174520	3
32	AZ-3N-B32	174521	3
40	AZ-3N-B40	174522	3
50	AZ-3N-B50	174523	3
63	AZ-3N-B63	174524	3
80	AZ-3N-B80	174525	3
100	AZ-3N-B100	174526	3
125	AZ-3N-B125	174527	3

SG51412



4-poles

20	AZ-4-B20	174532	3
25	AZ-4-B25	174533	3
32	AZ-4-B32	174534	3
40	AZ-4-B40	174535	3
50	AZ-4-B50	174536	3
63	AZ-4-B63	174537	3
80	AZ-4-B80	174538	3
100	AZ-4-B100	174539	3
125	AZ-4-B125	174540	3

Rated current I_n (A)

Type Designation

Article No.

Units per package

Characteristic C

SG51212



1-pole

20	AZ-C20	211769	12
25	AZ-C25	211774	12
32	AZ-C32	211779	12
40	AZ-C40	211784	12
50	AZ-C50	211789	12
63	AZ-C63	211794	12
80	AZ-C80	211799	12
100	AZ-C100	211804	12
125	AZ-C125	211809	12

SG51312



2-poles

20	AZ-2-C20	211770	6
25	AZ-2-C25	211775	6
32	AZ-2-C32	211780	6
40	AZ-2-C40	211785	6
50	AZ-2-C50	211790	6
63	AZ-2-C63	211795	6
80	AZ-2-C80	211800	6
100	AZ-2-C100	211805	6
125	AZ-2-C125	211810	6

wa_sg00314



3-poles

20	AZ-3-C20	211771	4
25	AZ-3-C25	211776	4
32	AZ-3-C32	211781	4
40	AZ-3-C40	211786	4
50	AZ-3-C50	211791	4
63	AZ-3-C63	211796	4
80	AZ-3-C80	211801	4
100	AZ-3-C100	211806	4
125	AZ-3-C125	211811	4

wa_sg00214



3+N-poles

20	AZ-3N-C20	211773	3
25	AZ-3N-C25	211778	3
32	AZ-3N-C32	211783	3
40	AZ-3N-C40	211788	3
50	AZ-3N-C50	211793	3
63	AZ-3N-C63	211798	3
80	AZ-3N-C80	211803	3
100	AZ-3N-C100	211808	3
125	AZ-3N-C125	211813	3

SG51412



4-poles

20	AZ-4-C20	211772	3
25	AZ-4-C25	211777	3
32	AZ-4-C32	211782	3
40	AZ-4-C40	211787	3
50	AZ-4-C50	211792	3
63	AZ-4-C63	211797	3
80	AZ-4-C80	211802	3
100	AZ-4-C100	211807	3
125	AZ-4-C125	211812	3

2.290 Miniature Circuit Breakers

AZ Miniature Circuit Breakers

xEffect

Rated
current
 I_n (A)

Type
Designation

Article No.

Units per
package

Characteristic D

SG51212



1-pole

20	AZ-D20	174489	12
25	AZ-D25	174490	12
32	AZ-D32	174491	12
40	AZ-D40	174492	12
50	AZ-D50	211814	12
63	AZ-D63	211818	12
80	AZ-D80	211822	12
100	AZ-D100	211826	12

SG51312



2-poles

20	AZ-2-D20	174502	6
25	AZ-2-D25	174503	6
32	AZ-2-D32	174504	6
40	AZ-2-D40	174505	6
50	AZ-2-D50	211815	6
63	AZ-2-D63	211819	6
80	AZ-2-D80	211823	6
100	AZ-2-D100	211827	6

wa_sg00314



3-poles

20	AZ-3-D20	174515	4
25	AZ-3-D25	174516	4
32	AZ-3-D32	174517	4
40	AZ-3-D40	174518	4
50	AZ-3-D50	211816	4
63	AZ-3-D63	211820	4
80	AZ-3-D80	211824	4
100	AZ-3-D100	211828	4

wa_sg00214



3+N-poles

20	AZ-3N-D20	174528	3
25	AZ-3N-D25	174529	3
32	AZ-3N-D32	174530	3
40	AZ-3N-D40	174531	3
50	AZ-3N-D50	211817	3
63	AZ-3N-D63	211821	3
80	AZ-3N-D80	211825	3
100	AZ-3N-D100	211829	3

SG51412



4-poles

20	AZ-4-D20	174541	3
25	AZ-4-D25	174542	3
32	AZ-4-D32	174543	3
40	AZ-4-D40	174544	3
50	AZ-4-D50	174545	3
63	AZ-4-D63	174546	3
80	AZ-4-D80	174547	3
100	AZ-4-D100	174548	3

Description

- Independent switching contacts
- With isolator function, meets the requirements of insulation co-ordination, distance between contacts ≥ 4 mm, for secure isolation

Accessories:

Auxiliary switch for subsequent installation (0.5 MU)	Z-LHK	248440
Shunt Trip Release for subsequent installation (1.5 MU)	Z-LHASA/230	248442
	Z-LHASA/24	248441
Switching interlock	LH-SPL	285752
	LHSP-E	215999
Switchoff interlock	LHSP-A	216000

Technical Data

AZ

Electrical

Standards	IEC/EN 60947-2
Classified according to	IEC 61373, EN 45545-2
Current test marks as printed onto the device	
Rated operating voltage	230/400 V AC 60 V DC (per pole)
Limiting breaking capacity according to IEC/EN 60947-2	
Characteristic B	$I_n = 20-63$ A: 25 kA $I_n = 80-100$ A: 20 kA $I_n = 125$ A: 15 kA
Characteristic C	$I_n = 20-63$ A: 25 kA $I_n = 80-100$ A: 20 kA $I_n = 125$ A: 15 kA
Characteristic D	$I_n = 20-63$ A: 25 kA $I_n = 80$ A: 20 kA $I_n = 100$ A: 15 kA
Characteristic	Similar: B, C, D
Max. back-up fuse	200 A gL/gG
Selectivity class	Compliant with class 3
Endurance	>10,000 Operations
Direction of incoming supply	Any

Mechanical

Frame size	45 mm
Device height	90 mm
Mounting width per pole	27 mm
Terminal protection	finger and hand touch safe according to BGV A2
Mounting	Top-hat rail to IEC/EN 60715
Terminals top and bottom	Lift terminals
Terminal capacity	2.5 – 50 mm ² (solid)
Operation temperature	-25 °C up to +55 °C
Storage- and transport temperature	-40 °C up to +75 °C

Connection diagram

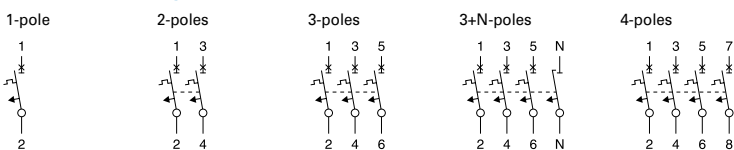

Dimensions (mm)

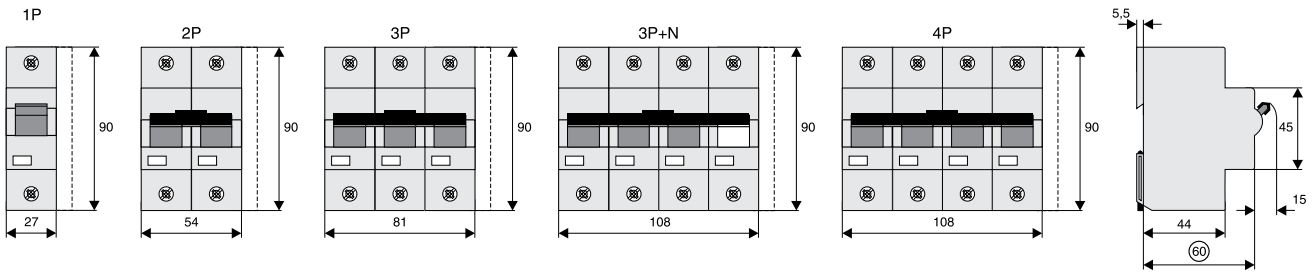

Influence of Ambient Temperature AZ

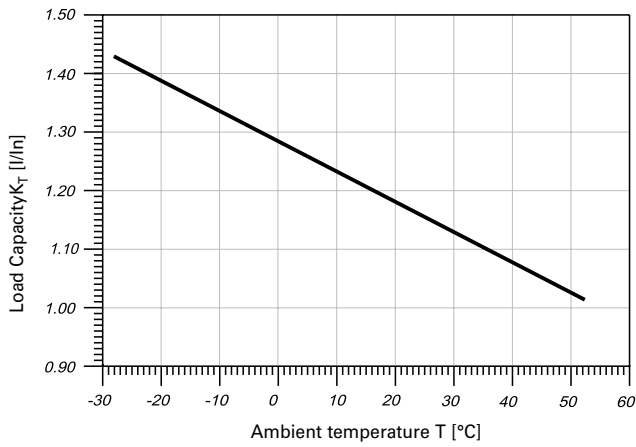

Permitted permanent load at ambient temperature T [°C] and n devices: $I_{DL} = I_n K_T(T) K_N(N)$.

Let-Through Energy AZ

Maximum Let-Through Energy AZ, Characteristic B, 1poles

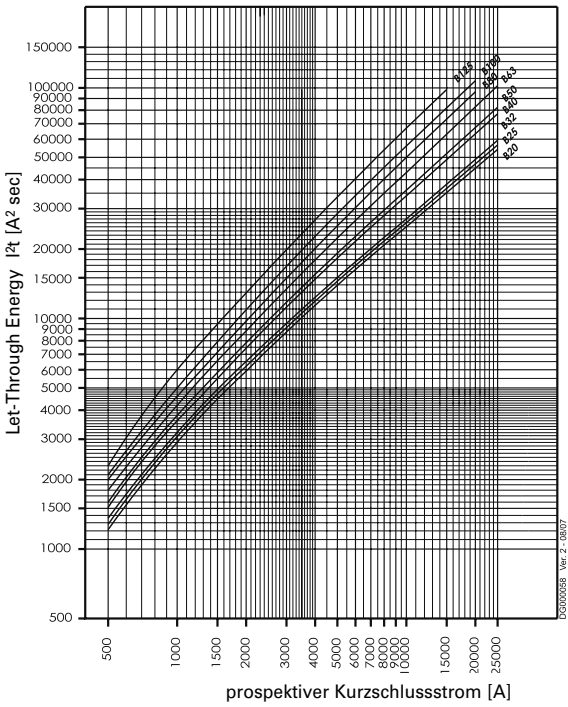

Maximum Let-Through Energy AZ, Characteristic C, 1poles

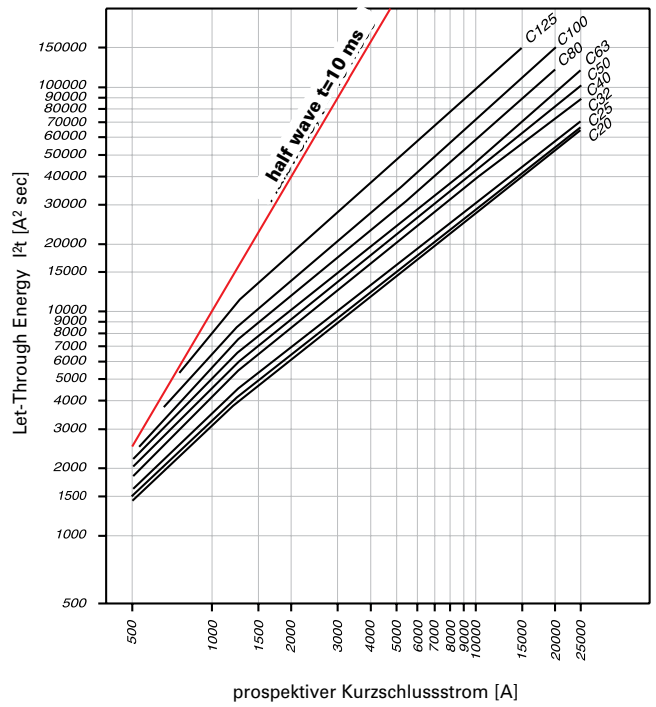

Maximum Let-Through Energy AZ, Characteristic D, 1poles

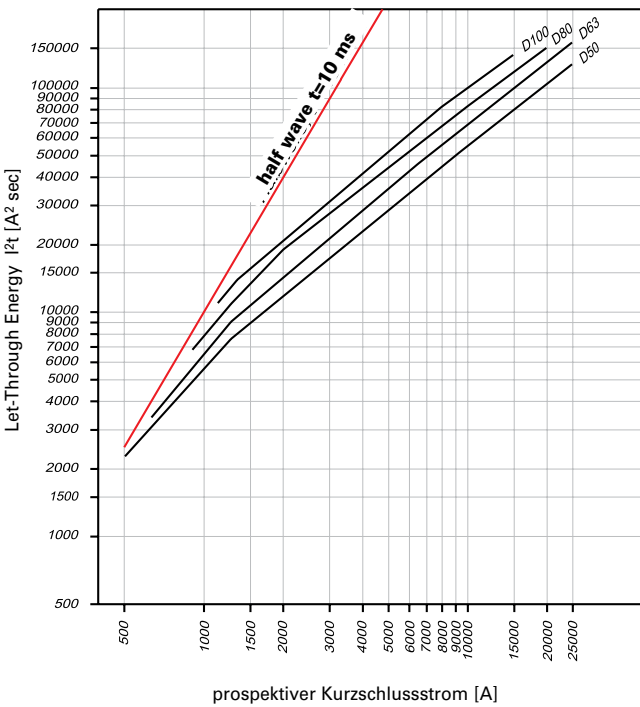

Determined according to EN 60898-1.

Maximum Let-Through Current AZ

Type B

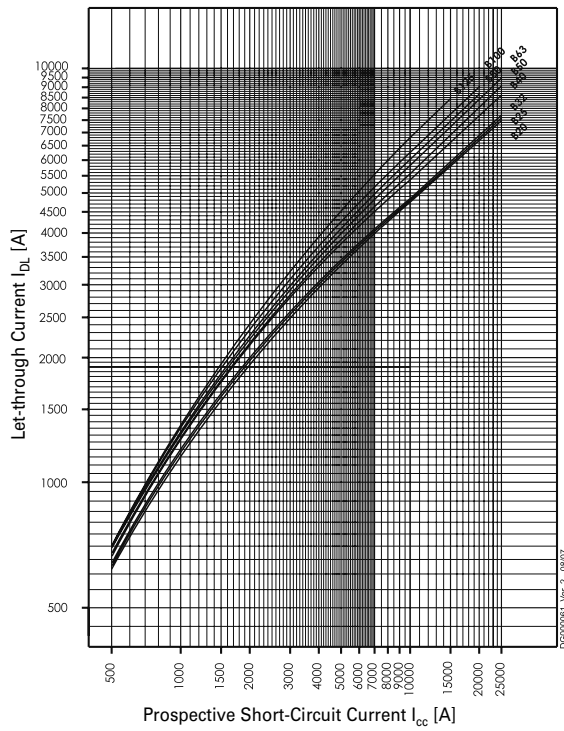

Type C

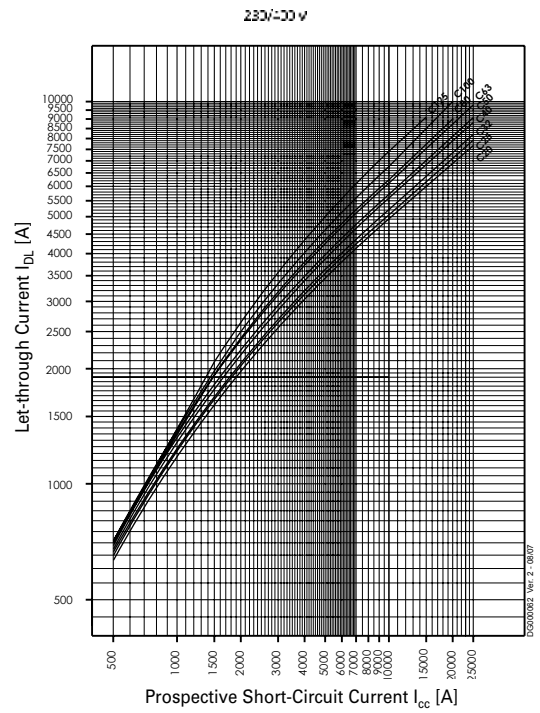

Type D

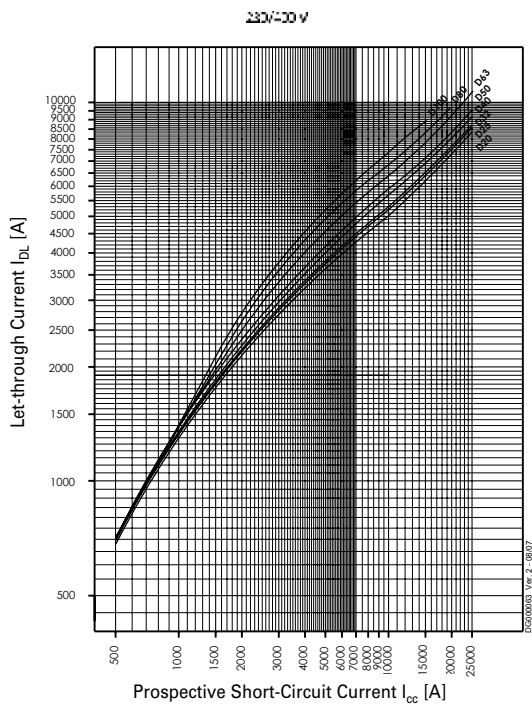

Short Circuit Selectivity AZ

In case of short circuit, there is selectivity between the miniature circuit breakers AZ and the upstream protection devices up to the specified values of the selectivity limit current I_s [kA] (i. e. in case of short-circuit currents I_{ks} under I_s , only the MCB will trip, in case of short circuit currents above this value both protective devices will respond).

AZ towards back-up fuses D01, D02, D03

Characteristic C

AZ	D01. D02. D03					
I_n [A]	25	35	50	63	80	100
20	0.5	1.0	2.0	2.9	3.9	7.6
25		1.0	1.9	2.8	3.8	7.3
32		1.0	1.8	2.7	3.6	7.0
40			1.6	2.2	3.0	5.6
50				2.1	2.8	5.2
63					2.7	4.8
80						4.3
100						
125						

Characteristic D

AZ	D01. D02. D03					
I_n [A]	25	35	50	63	80	100
20	0.5	0.9	1.7	2.5	3.4	6.7
25		0.9	1.6	2.3	3.2	6.2
32		0.9	1.5	2.3	3.0	6.0
40			1.4	2.0	2.6	4.7
50				1.8	2.3	4.3
63					2.1	3.7
80						3.1
100						

AZ towards back-up fuses NH Gr. 00

Characteristic C

AZ	NH Gr. 00									
I_n [A]	25	35	40	50	63	80	100	125	160	200
20	0.5	1.0	1.3	1.9	2.7	3.7	6.7	17.0	25.0	25.0
25		0.9	1.3	1.8	2.6	3.5	6.5	17.0	25.0	25.0
32		0.9	1.2	1.7	2.4	3.3	6.0	15.0	23.0	25.0
40				1.4	2.1	2.9	4.8	12.0	18.0	25.0
50					1.9	2.7	4.5	11.0	17.0	25.0
63							4.2	10.0	15.0	25.0
80							3.8	8.5	12.0	25.0
100								7.0	10.0	25.0
125									7.5	25.0

Characteristic D

AZ	NH Gr. 00									
I_n [A]	25	35	40	50	63	80	100	125	160	200
20	<0.5	0.8	1.1	1.5	2.3	3.1	5.6	16.0	25.0	25.0
25		0.7	1.0	1.4	2.1	3.0	5.3	14.0	23.0	25.0
32		0.7	1.0	1.3	2.1	2.9	5.0	13.0	22.0	25.0
40				1.1	1.8	2.5	4.2	10.0	15.0	25.0
50					1.6	2.3	3.8	8.5	13.0	22.0
63						2.1	3.2	7.0	10.5	18.0
80							2.8	5.5	8.4	15.0
100								4.8	7.5	12.5

AZ towards NZM 1

Characteristic C

AZ	NZM...1-A gL/gG					
I_n [A]	40	50	63	80	100	125
20	0.5	1.0	1.3	1.9	2.7	3.7
20	0.3	0.4	0.5	0.75	0.9	1.25
25	0.3	0.4	0.5	0.7	0.9	1.2
32		0.4	0.5	0.7	0.85	1.2
40			0.5	0.6	0.85	1.1
50				0.6	0.85	1.1
63					0.8	1
80						1
100						
125						

Characteristic D

AZ	NZM...1-A gL/gG					
I_n [A]	40	50	63	80	100	125
50						
63						
80						
100						

Shaded fields: no selectivity

AZ towards NZM 2

Characteristic C

AZ	NZM...2-A gL/gG									
I _n [A]	40	50	63	80	100	125	160	200	250	
20	0.3	0.4	0.5	0.75	0.9	1.25	1.8	2.5	3.5	
25	0.3	0.4	0.5	0.7	0.9	1.2	1.7	2.4	3.3	
32		0.4	0.5	0.7	0.85	1.2	1.65	2.3	3.2	
40			0.5	0.6	0.85	1.1	1.5	2.1	2.9	
50				0.6	0.85	1.1	1.5	2	2.8	
63					0.8	1	1.4	1.8	2.5	
80						1	1.4	1.8	2.4	
100							1.3	1.7	2.3	
125								1.6	2.1	

Characteristic D

AZ	NZM...2-A gL/gG									
I _n [A]	40	50	63	80	100	125	160	200	250	
50								1	1.4	2.6
63								1	1.3	2.3
80										2.1
100										

Shaded fields: no selectivity

Back-up Protection AZ

The up-stream protective devices will protect the down-stream AZ up to the short-circuit current specified.

AZ and NZM(B)(C)(N)(H)1

AZ	NZMB1
I_n [A]	$U_e = 230/400$ V
20	25 kA
25	25 kA
32	25 kA
40	25 kA
50	25 kA
63	25 kA
80	25 kA
100	25 kA
125	25 kA

AZ	NZMC1
I_n [A]	$U_e = 230/400$ V
20	36 kA
25	36 kA
32	36 kA
40	36 kA
50	36 kA
63	36 kA
80	36 kA
100	36 kA
125	36 kA

AZ	NZMN1
I_n [A]	$U_e = 230/400$ V
20	50 kA
25	50 kA
32	50 kA
40	50 kA
50	50 kA
63	50 kA
80	50 kA
100	50 kA
125	50 kA

AZ	NZMH1
I_n [A]	$U_e = 230/400$ V
20	80 kA
25	80 kA
32	80 kA
40	80 kA
50	80 kA
63	80 kA
80	80 kA
100	80 kA
125	80 kA

AZ and NZM(B)(C)(N)(H)2

AZ	NZMB2
I_n [A]	$U_e = 230/400$ V
20	25 kA
25	25 kA
32	25 kA
40	25 kA
50	25 kA
63	25 kA
80	25 kA
100	25 kA
125	25 kA

AZ	NZMC2
I_n [A]	$U_e = 230/400$ V
20	36 kA
25	36 kA
32	36 kA
40	36 kA
50	36 kA
63	36 kA
80	36 kA
100	36 kA
125	36 kA

AZ	NZMN2
I_n [A]	$U_e = 230/400$ V
20	50 kA
25	50 kA
32	50 kA
40	50 kA
50	50 kA
63	50 kA
80	50 kA
100	50 kA
125	50 kA

AZ	NZMH2
I_n [A]	$U_e = 230/400$ V
20	65 kA
25	65 kA
32	65 kA
40	65 kA
50	65 kA
63	65 kA
80	65 kA
100	65 kA
125	65 kA

Load capacity in case of block installation AZ

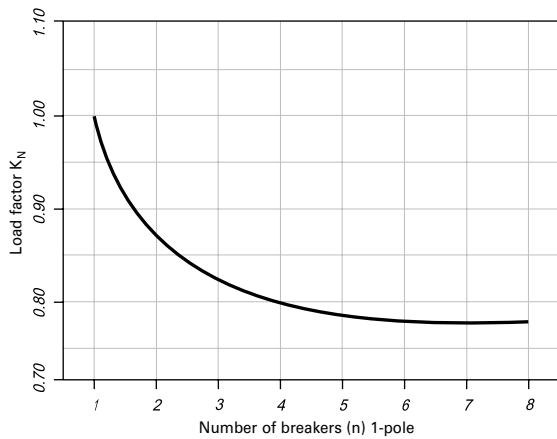

Derating table for AZ above 2000m sea level

60947-2

U_e 230/400 V

80/B, C, D and 100/B, C 80, 100/B, C, D 100/D and 125/B, C 100/D and 125/B, C

Above sea level (m)	Overvoltage category	Disconnect function	I/I_n	I_{cu}	I_{cs}	I_{cu}	I_{cs}
m	x	x	x	kA	kA	kA	kA
≤2000	III	yes	1	20	10	15	7.5
>2000-2500	II	no	0.93	15	7.5	10	6
>2500-3000	II	no	0.88	15	7.5	10	6
>3000-3500	II	no	0.83	15	7.5	10	6
>3500-4000	II	no	0.78	15	7.5	10	6

sg09615



Description

- Photovoltaic - Switch-disconnectors
- Acc .to EN 60947-3 DC-PV1 or DC-PV2 resp.
- Very compact
- Improved reliability due to independent manual operation
- Stable performance at any load current
- Polarity independent
- Only one path per pole => lower power loss

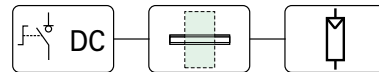

2.300 Photovoltaic - DC-Disconnection

DC Switch-Disconnecter PV-DIS 2-poles

sg09615



Rated operating current I _e (A)	Type Designation	Article No.	Units per package
2-poles with rotary handle, 600 V			
16	PV-DIS-06-16/2-ROT	179259	1
32	PV-DIS-06-32/2-ROT	179260	1
63	PV-DIS-06-63/2-ROT	179261	1
100	PV-DIS-06-100/2-ROT	185503	1
125	PV-DIS-06-125/2-ROT	179262	1
2-poles with rotary handle, 800 V			
16	PV-DIS-08-16/2-ROT	179263	1
32	PV-DIS-08-32/2-ROT	179264	1
63	PV-DIS-08-63/2-ROT	179265	1
100	PV-DIS-08-100/2-ROT	185504	1
125	PV-DIS-08-125/2-ROT	179266	1
2-poles with rotary handle, 1000 V			
16	PV-DIS-10-16/2-ROT	179267	1
32	PV-DIS-10-32/2-ROT	179268	1
63	PV-DIS-10-63/2-ROT	179269	1
100	PV-DIS-10-100/2-ROT	185505	1
125	PV-DIS-10-125/2-ROT	179270	1
2-poles without rotary handle, 600 V			
16	PV-DIS-06-16/2	179255	1
32	PV-DIS-06-32/2	179256	1
63	PV-DIS-06-63/2	179257	1
100	PV-DIS-06-100/2	185502	1
125	PV-DIS-06-125/2	179258	1

Technical Data

	PV-DIS-06...	PV-DIS-08...	PV-DIS-10...
Rated operating voltage	600 V	800 V	1000 V
Rated impulse withstand voltage	4 kV	6 kV	6 kV
	PV-DIS-.../2	PV-DIS-.../2-ROT	
Rated insulation voltage	630 V	1000 V	
Utilization category (acc. to EN 60947-3)			
Rated operating current I _b 16-100 A	DC-PV2		
Rated operating current I _b 125 A	DC-PV1		
Mechanical operations	acc. to IEC 60947-3 Category of utilization DC-PV2 or DC-PV1		
Electrical operations	acc. to IEC 60947-3 Category of utilization DC-PV2 or DC-PV1		
Rated frequency / Operating frequency	DC only		
Approbation	ÖVE, VDE		
Resistance to climatic conditions according to	IEC 60947-2		
Shock resistance, Vibration resistance acc. to	IEC 60947-2		
Dimensions	according to drawing		
Dimensions of terminals	2.5-50 mm ²		
Cable material	Cu		
Degree of protection	IP20		
Degree of protection, built-in	IP40		
Mounting position	DIN-Rail, Rotation +90°, -90°, 180°		
Ambient temperature range	40 to +85 °C		
Storage Temperature	40 to +85 °C		
Max. DC contact rating	100 %		
Safe electrical isolation	yes		
Supply side	interchangeable		
Polarity	interchangeable		

Wiring Examples

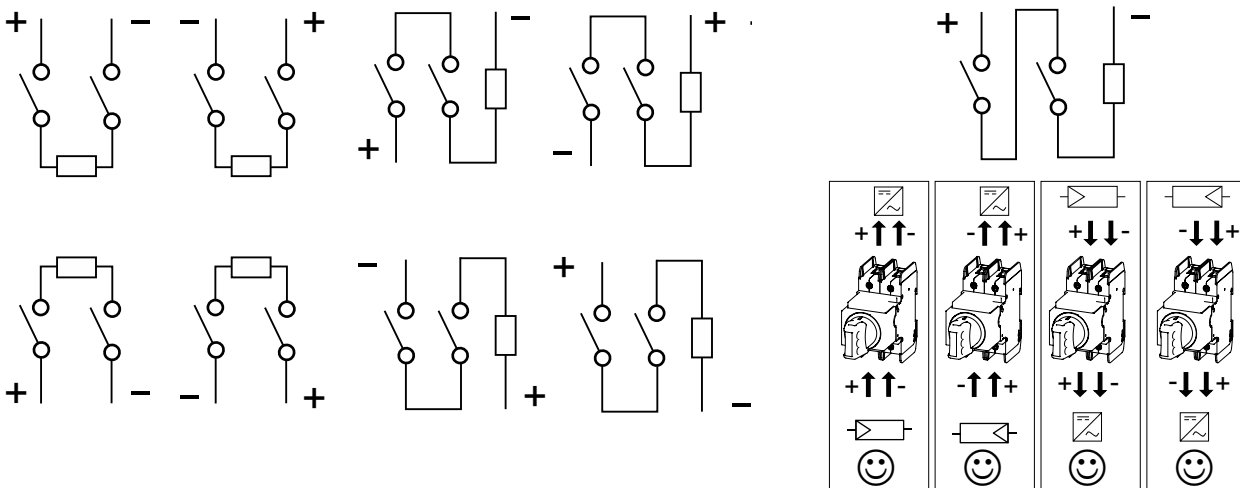

Dimensions (mm)

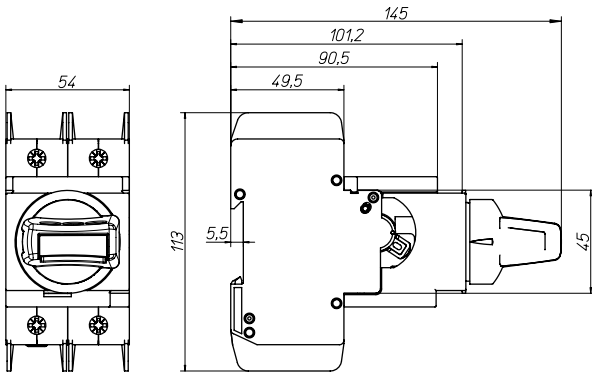

2-poles with rotary handle

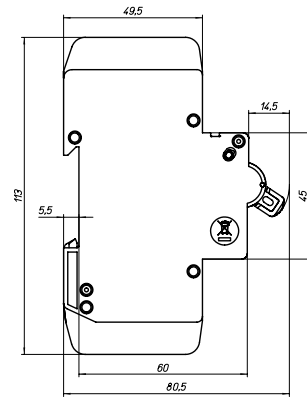
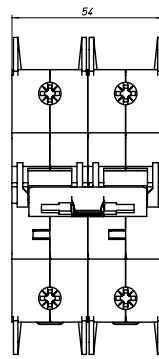

2-poles without rotary handle

Rated operating current at different voltages

DC-PV1: Switching of single PV string(s) without reverse and overcurrents

DC-PV2: Switching of several PV strings with reverse and overcurrents

2-poles with rotary handle, 600V

Type designation	PV-DIS-06-16/2(-ROT)	PV-DIS-06-32/2(-ROT)	PV-DIS-06-63/2(-ROT)	PV-DIS-06-100/2(-ROT)	PV-DIS-06-125/2(-ROT)
DCPV1	Utilization category (acc. to EN 60947-3)				
Rated operating voltage (DC)	Rated operating current I _e				
300V	16A	32A	63A	100A	125A
400V					
500V					
600V					

Type designation	PV-DIS-06-16/2(-ROT)	PV-DIS-06-32/2(-ROT)	PV-DIS-06-63/2(-ROT)	PV-DIS-06-100/2(-ROT)	PV-DIS-06-125/2(-ROT)
DCPV2	Utilization category (acc. to EN 60947-3)				
Rated operating voltage (DC)	Rated operating current I _e				
300V	16A	32A	63A	100A	125A
400V					
500V					
600V					

2-poles without rotary handle, 600V

Type designation	PV-DIS-06-16/2	PV-DIS-06-32/2	PV-DIS-06-63/2	PV-DIS-06-100/2	PV-DIS-06-125/2
DCPV2	Utilization category (acc. to EN 60947-3)				
Rated operating voltage (DC)	Rated operating current I _e				
300V	16A	32A	63A	100A	125A
400V					
500V					
600V					

2-poles with rotary handle, 800 V

Type designation	PV-DIS-06-16/2(-ROT)	PV-DIS-06-32/2(-ROT)	PV-DIS-06-63/2(-ROT)	PV-DIS-06-100/2(-ROT)	PV-DIS-06-125/2(-ROT)
DCPV1	Utilization category (acc. to EN 60947-3)				
Rated operating voltage (DC)	Rated operating current I _e				
300V	16A	32A	63A	100A	125A
400V					
500V					
600V					
700V					
800V					

Type designation	PV-DIS-06-16/2(-ROT)	PV-DIS-06-32/2(-ROT)	PV-DIS-06-63/2(-ROT)	PV-DIS-06-100/2(-ROT)	PV-DIS-06-125/2(-ROT)
DCPV2	Utilization category (acc. to EN 60947-3)				
Rated operating voltage (DC)	Rated operating current I _e				
300V	16A	32A	63A	100A	125A
400V					
500V					
600V					
700V					
800V					

Rated operating current at different voltages

DC-PV1: Switching of single PV string(s) without reverse and overcurrents

DC-PV2: Switching of several PV strings with reverse and overcurrents

2-poles with rotary handle, 1000 V

Type designation	PV-DIS-06-16/2(-ROT)	PV-DIS-06-32/2(-ROT)	PV-DIS-06-63/2(-ROT)	PV-DIS-06-100/2(-ROT)	PV-DIS-06-125/2(-ROT)
DCPV1	Utilization category (acc. to EN 60947-3)				
Rated operating voltage (DC)	Rated operating current I _o				
300V	16A	32A	63A	100A	125A
400V					
500V					
600V					
700V					
800V					
900V					
1000V					

Type designation	PV-DIS-06-16/2(-ROT)	PV-DIS-06-32/2(-ROT)	PV-DIS-06-63/2(-ROT)	PV-DIS-06-100/2(-ROT)	PV-DIS-06-125/2(-ROT)
DCPV2	Utilization category (acc. to EN 60947-3)				
Rated operating voltage (DC)	Rated operating current I _o				
300V	16A	32A	63A	100A	125A
400V					
500V					
600V				90A	110A
700V					
800V					
900V					
1000V					
80A					
100A					

SG10911







Description

- Load circuit breaker with isolating function
- Highly wear resistant contacts
- Quick make
- Terminal capacity 50 mm²
- Compatible busbars
- 1-, 2-, 3-, 4-pole
- Classified for the use in rail rolling stock



2.306 Main Load Disconnecter Switch

xEffect

Main Load Disconnecter Switch (Isolator) IS

	Rated Current (A)	Number of Poles	Type Designation	Article No.	Units per package
	16	1	IS-16/1	276254	12/120
	16	2	IS-16/2	276255	1/60
	16	3	IS-16/3	276256	1/40
	16	4	IS-16/4	276257	1/30
	20	1	IS-20/1	276258	12/120
	20	2	IS-20/2	276259	1/60
	20	3	IS-20/3	276260	1/40
	20	4	IS-20/4	276261	1/30
	25	1	IS-25/1	276262	12/120
	25	2	IS-25/2	276263	1/60
	25	3	IS-25/3	276264	1/40
	25	4	IS-25/4	276265	1/30
	32	1	IS-32/1	276266	12/120
	32	2	IS-32/2	276267	1/60
	32	3	IS-32/3	276268	1/40
	32	4	IS-32/4	276269	1/30
	40	1	IS-40/1	276270	12/120
	40	2	IS-40/2	276271	1/60
	40	3	IS-40/3	276272	1/40
	40	4	IS-40/4	276273	1/30
	63	1	IS-63/1	276274	12/120
	63	2	IS-63/2	276275	1/60
	63	3	IS-63/3	276276	1/40
	63	4	IS-63/4	276277	1/30
	80	1	IS-80/1	276278	12/120
	80	2	IS-80/2	276279	1/60
	80	3	IS-80/3	276280	1/40
	80	4	IS-80/4	276281	1/30
	100	1	IS-100/1	276282	12/120
	100	2	IS-100/2	276283	1/60
	100	3	IS-100/3	276284	1/40
	100	4	IS-100/4	276285	1/30
	125	1	IS-125/1	276286	12/120
	125	2	IS-125/2	276287	1/60
	125	3	IS-125/3	276288	1/40
	125	4	IS-125/4	276289	1/30

Accessories

	Description	Type Designation	Article No.	Units per package
	Switching interlock without lock for Isolators, RCDs, combined RCD/MCBs, ...	IS/SPE-1TE	101911	5/30
	Terminal cover	Z-IS/AK-1TE	276290	10/600

Switching interlock IS/SPE-1TE

- Without lock
- Also suitable for PFIM, CF16, PKNM, CKN6

Terminal Cover Caps Z-IS/AK-1TE

- Can be sealed with leads
- Modular design, width 1 MU

Description

- Load circuit breaker with isolating function
- Design according to IEC/EN 60947-3
- Highly wear resistant contacts
- Quick make, black toggle
- Terminal capacity 50 mm²
- Compatible busbars with switchgear series Xpole by use of the mouth terminal in combination with standard fork busbar

Technical Data

	IS-16	IS-20	IS-25	IS-32	IS-40	IS-63	IS-80	IS-100	IS-125
Electrical									
Design	according to IEC/EN 60947-3								
Classified according to	IEC 61373, EN 45545-2								
Current test marks as printed onto the device									
Rated voltage	240/415 V								
Frequency	50/60 Hz								
Rated insulation voltage	U _i	690 V~							
Rated impulse withstand voltage	U _{imp}	6 kV							
Pollution degree	3								
Rated short-time withstand current	I _{cw}	2 kA							
Rated short-circuit making capacity	I _{cm}	2.8 kA							
Rated current 240/415V, AC23A	16 A	20 A	25 A	32 A	40 A	63 A	80 A	100 A	125 A
Number of poles	1-, 2-, 3-, 4-poles								
Maximum back-up fuse	125 A gG								
Short circuit strength - with back-up fuse according to IEC/EN 60947-3	12.5 kA	12.5 kA	12.5 kA	12.5 kA	12.5 kA	12.5 kA	12.5 kA	10 kA	10 kA
Endurance									
Electrical components operation cycles	≥ 3,000	≥ 3,000	≥ 3,000	≥ 3,000	≥ 3,000	≥ 3,000	≥ 3,000	≥ 3,000	≥ 2,000
Mechanical components operation cycles	≥ 16,000	≥ 16,000	≥ 16,000	≥ 16,000	≥ 16,000	≥ 16,000	≥ 16,000	≥ 16,000	≥ 14,000
Mechanical									
Frame size	45 mm								
Device height	80 mm								
Device width	17.5 mm/Pol								
Mounting	quick fastening with 2 lock-in positions on DIN rail IEC/EN 60715								
Degree of protection, built-in	IP40								
Terminal protection	finger and hand touch safe according to BGV A3								
Terminals top and bottom	open mouthed/lift terminals								
Terminal capacity	2.5 - 50 mm ²								
Busbar thickness	0.8 - 2 mm								
Fastening torque of terminal screws	2.5 - 5 Nm								
Function	irrespective of the position of installation								
Operation temperature	-25°C up to +40°C								
Storage- and transport temperature	-35°C up to +75°C								

Connection diagram

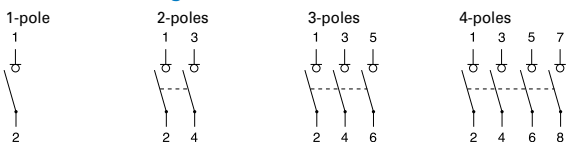

Dimensions (mm)

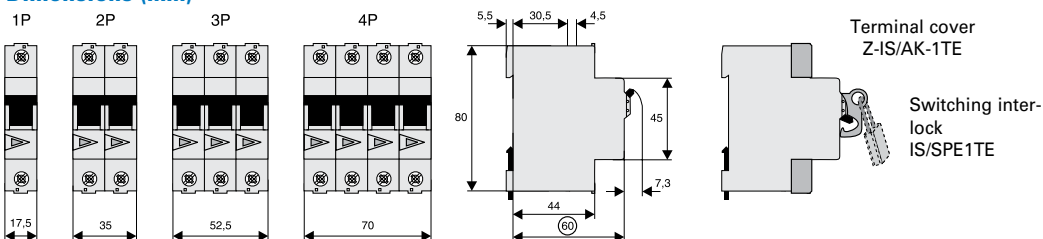

2.308 Main Load Disconnecter Switch

Main Load Disconnecter Switch (Isolator) IS

Derating table for Main Load Disconnecter Switch (Isolator) IS above 2000m sea level

60947-3

U_n 240/415

Above sea level (m)	Overvoltage category	Disconnect function	U_n	U_i	U_{imp}	I/I_n
m	x	x	V	V	kV	x
≤2000	III	yes	240/415	690	6	1
>2000-2500	III	yes	240/415	415	4	0.93
>2500-3000	III	yes	240/415	415	4	0.88
>3000-3500	III	yes	240/415	415	4	0.83
>3500-4000	III	yes	240/415	415	4	0.78

SG30811

SG60811



Description

- SWD Auxiliary Module
- Auxiliary Switch
- RCD-Tripping Module
- Shunt Trip Release
- Undervoltage Release
- Remote Control and Automatic Switching Device
- Switching Interlocks
- Terminal Covers

2.310 Accessories for Protective Devices

Auxiliary SWD Module for MCBs, RCCBs and RCBOs

SG00114, sp01515



Description	Type Designation	Article No.	Units per package
SWD Module	MCB-HK-SWD	177175	1
Spare End Cap	SWD4-OS	178150	10

Description Auxiliary SWD Module

- Auxiliary module for the connection of an MCB, RCCB or RCBO to the SWD line
- Connection to an RCCB on the left side and to an MCB or RCBO on the right side
- Communication of on/off and trip status, trip indicator
- SWD connection on the top and bottom possible
- Integrated SWD-bus LED

Technical Data

	MCB-HK-SWD
Pollution degree	2
Degree of protection	IP20
Power supply	via SWD line
Operation temperature	-25 up to +40°C
Dimensions	W x H x D = 17.5 x 88.3 x 77.3 mm

Combination with the following Types

RCCB

Residual Current Devices FRcdM, digital	✓
Residual Current Devices FRcmM	✓
Residual Current Devices FRcmM-NA & NA-110	✓
Residual Current Devices FRcmM-125	–

RCBO





Combined RCD/MCB Devices FRBdM, digital	✓
FI/LS-RCBO FRBmM, FRBm6, FRBm4	✓
Add-on Residual Current Protection Unit FBSmV	✓ (only on MCB side)
Add-on Residual Current Protection Unit FBHmV	–

MCB

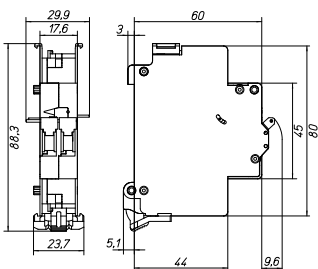
Miniature Circuit Breaker FAZ	✓
Miniature Circuit Breaker FAZ-PN	✓
Miniature Circuit Breaker FAZ-HS	✓
Miniature Circuit Breaker FAZ-T	✓
Miniature Circuit Breaker FAZ-DC	✓
Miniature Circuit Breaker FAZ-NA, FAZ-RT	–
Miniature Circuit Breaker FAZ-NA-DC	–
Miniature Circuit Breaker AZ	–
Main Load Disconnect Switch (Isolator) IS	–

Dimensions (mm)



	For Protective Device / Function	Type Designation	Article No.	Units per package
Design: for screwing				
	RCCB / 1NO+1NC	Z-HK	248432	4/120
	MCB, RCBO (1+N, 3P, 3+N) / 1NO+1NC	Z-AHK	248433	4/120
	MCB, RCBO, RCCB / 2CO	Z-NHK	248434	4/120
	RCCB / 1CO+1NC	Z-HD	265620	1

Description Auxiliary Switch Z-HK, Z-AHK; Tripping Signal Switch Z-NHK

- Design according to IEC/EN 60947-5-1, IEC/EN 62019
- Can be mounted subsequently (screws) onto FRCmM, FRCdM
- The specified minimum voltages are per contact.
Take into account particularly in case of series connection!
- **Z-AHK, Z-NHK:** Contact function with relative movement (selfcleaning contacts)
- Contact material and design particularly suitable for extra low voltage
- **Z-NHK:** The function of one of the two change-over contacts can be switched from "auxiliary switch" to "tripping signal switch"
- Tripping signal contact transmits message of electric tripping, not mechanical switch-off
- Test key for contact function "electrical tripping"

Technical Data

	Z-HK	Z-AHK	Z-NHK
Electrical			
Classified according to	IEC 61373, EN 45545-2		
Current test marks as printed onto the device			
Contact function	1NO + 1NC	1NO + 1NC	2CO
Rated voltage	250 V	250 V	250 V
Frequency	50/60 Hz	50/60 Hz	50/60 Hz
Rated current	8 A	4 A	4 A
Rated thermal current	I_{th} 8 A	4 A	4 A
Utilisation category AC13			
Rated operational current	I_e 6 A / 250 V AC 2 A / 440 V AC	3 A / 250 V AC –	3 A / 250 V AC –
Utilisation category AC15			
Rated operational current	I_e –	2 A / 250 V AC	2 A / 250 V AC
Utilisation category DC12			
Rated operational current	I_e –	0.5 A / 110 V DC	0.5 A / 110 V DC
Utilisation category DC13			
Rated operational current	I_e 0.5 A / 230 V DC 2 A / 110 V DC 4 A / 60 V DC	– – –	– – –
Rated insulation voltage	U_i 250 V AC	250 V AC	250 V AC
Minimum operational voltage per contact	U_{min} 24 V AC/DC	5 V DC	5 V DC
Minimum operational current	I_{min} 50 mA AC/DC	10 mA DC	10 mA DC
Rated impulse withstand voltage (1,2/50 μ)	U_{imp} 2.5 kV	2.5 kV	2.5 kV
Conditional short circuit current with back-up fuse 6 A or FAZ-B4-HS	1 kA	1 kA	1 kA
Max. back-up fuse, overload and short circuit	6 A gL / FAZ-4/.. /B-HS	4 A gL / FAZ-4/.. /B-HS	4 A gL / FAZ-4/.. /B-HS
Mechanical			
Can be mounted from the left onto	RCCB	MCB, RCBO (1+N, 3P, 3+N) MCB, RCBO	
Can be mounted from the right onto	–	–	FI
Tripping indicator “electrical tripping”	–	–	blue/white
Frame size	45 mm	45 mm	45 mm
Device height	80 mm	80 mm	80 mm
Device width	8.8 mm (0.5MU)	8.8 mm (0.5MU)	8.8 mm (0.5MU)
Mounting	onto switching device	onto switching device	onto switching device
Degree of protection, built-in	IP40	IP40	IP40
Terminal protection	finger and hand touch safe according to DGUV VS3, EN 50274		
Terminals	Lift terminals	Lift terminals	Lift terminals
Terminal capacity	0.5-2.5 mm ²	0.5-2.5 mm ²	0.5-2.5 mm ²
Terminal screws	M3.5 (Pozidrive Z2)	M3 (Pozidrive Z1)	M3 (Pozidrive Z1)
Fastening torque of terminal screws	max. 0.8-1.0 Nm	max. 0.8-1.0 Nm	max. 0.8-1.0 Nm

Connection diagram

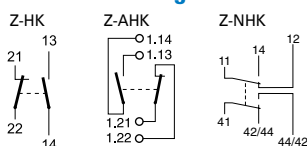

Dimensions (mm)

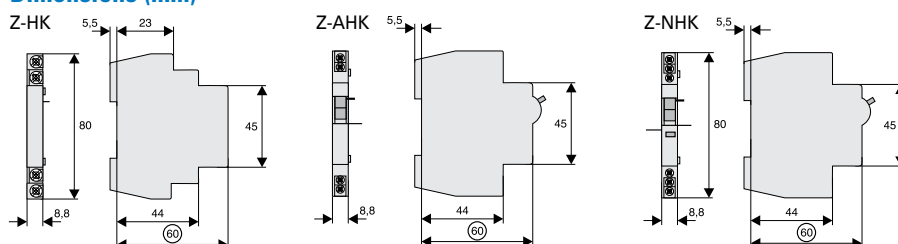

Example: Z-HK+FI

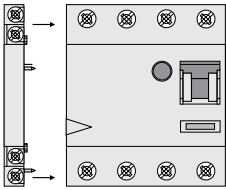

1NO+1NC 24V 50mA min.

Example: Z-AHK+LS

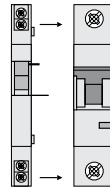

1NO+1NC 5V 10mA min.

Example: Z-NHK+LS FI+Z-NHK

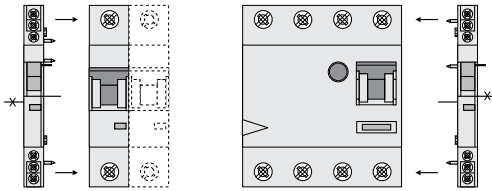

2CO 5V 10mA min.

Description Auxiliary Switch Z-HD

Function Auxiliary Switch Z-HD

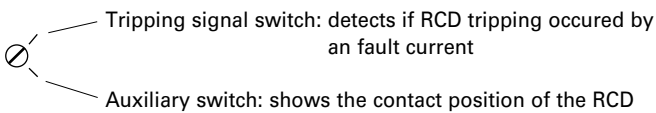

Technical Data

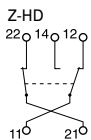

	Z-HD
Electrical	
Can be mounted from the left onto	FRCmM-125A
Contact functions	1CO + 1NC
Min. creeping distance	> 12.7 mm/50.8 mm (intern/external)
Load rating	
AC11	6 A / 230 V AC
DC11	1 A / 230 V DC
Mechanical	
Terminal capacity	up to 2.5 mm ²

Connection diagram

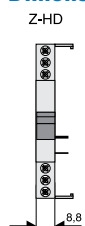

Dimensions (mm)



	For Protective Device / Function	Type Designation	Article No.	Units per package
Design: for snapping				
SG60811 	MCB, RCBO / 1NO+1NC	ZP-IHK	286052	4/120
SG34612 	MCB, RCBO / 1CO	ZP-WHK	286053	4/120
SG34512 	MCB, RCBO / 2CO	ZP-NHK	248437	4/120

Description Auxiliary Switch ZP-IHK, ZP-WHK; Tripping Signal Switch ZP-NHK

- Design according to IEC/EN 62019
- No screws required. Can be snapped onto FAZ and FRBmM-1N subsequently
- **ZP-IHK, ZP-WHK:** Can be snapped on additionally 1 time onto itself
- The specified minimum voltages are per contact. Take into account particularly in case of series connection!
- Contact material and design particularly suitable for extra low voltage.
- Contact function with relative movement (self-cleaning contacts)e)
- **ZP-NHK:** The function of one of the two change-over contacts can be switched from "auxiliary switch" to „tripping signal switch“
- Tripping signal contact transmits message of electric tripping, not mechanical switch-off
- **ZP-NHK:** The "Service button" is used to check whether or not the auxiliary switch is correctly wired in the tripping-signal-switch position. Activating the "service button" will mechanically simulate an electrical switch-off, so the mechanism for the electrical switchoff will disengage and can be checked. The main switchgear (MCB or combined MCB/RCD) connected to the ZP-NHK auxiliary switch does not need to trip as well during an inspection through the service button.

Technical Data

	ZP-IHK	ZP-WHK	ZP-NHK
Electrical			
Classified according to	IEC 61373, EN 45545-2		
Current test marks as printed onto the device			
Contact function	1NO + 1NC	1CO	2CO
Rated voltage	250 V	250 V	250 V
Frequency	50/60 Hz	50/60 Hz	50/60 Hz
Rated current	6 A	6 A	4 A
Rated thermal current	I_{th} 6 A	6 A	4 A
Utilisation category AC13			
Rated operational current	I_e 3 A / 250 V AC	3 A / 250 V AC	3 A / 250 V AC
Utilisation category AC15			
Rated operational current	I_e 2 A / 250 V AC	2 A / 250 V AC	2 A / 250 V AC
Utilisation category DC12			
Rated operational current	I_e 0.5 A / 110 V DC	0.5 A / 110 V DC	0.5 A / 110 V DC
Rated insulation voltage	U_i 250 V AC	250 V AC	250 V AC
Minimum operational voltage per contact	U_{min} 5 V DC	5 V DC	5 V DC
Minimum operational current	I_{min} 10 mA DC	10 mA DC	10 mA DC
Rated impulse withstand voltage (1,2/50 μ)	U_{imp} 2.5 kV	2.5 kV	2.5 kV
Conditional short circuit current with back-up fuse 6 A or FAZ-B4-HS	1 kA	1 kA	1 kA
Max. back-up fuse, overload and short circuit	6 A gL / FAZ-4/./B-HS	6 A gL / FAZ-4/./B-HS	6 A gL / FAZ-4/./B-HS
Mechanical			
Can be mounted from the left onto	MCB, RCBO	MCB, RCBO	MCB, RCBO
Accessories	ZP-ASA	ZP-ASA	ZP-ASA
Tripping indicator "electrical tripping"	–	–	blue/white
Frame size	45 mm	45 mm	45 mm
Device height	80 mm	80 mm	80 mm
Device width	8.8 mm (0.5MU)	8.8 mm (0.5MU)	8.8 mm (0.5MU)
Mounting	onto switching device	onto switching device	onto switching device
Degree of protection, built-in	IP40	IP40	IP40
Terminal protection	finger and hand touch safe according to DGUV VS3, EN 50274		
Terminals	Lift terminals	Lift terminals	Lift terminals
Terminal capacity	0.5-2.5 mm ²	0.5-2.5 mm ²	0.5-2.5 mm ²
Terminal screws	M4 (Pozidrive Z2)	M4 (Pozidrive Z2)	M3 (Pozidrive Z1)
Fastening torque of terminal screws	max. 1.2 Nm	max. 1.2 Nm	max. 0.8-1.0 Nm

Connection diagram

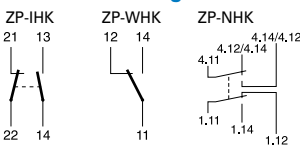

Dimensions (mm)

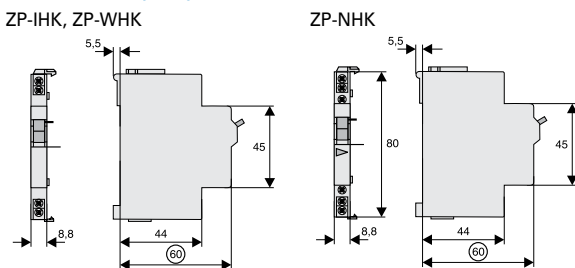

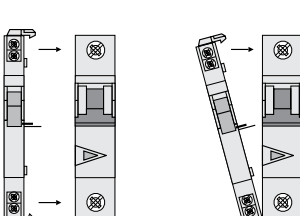

Example: ZP-IHK/(ZP-WHK)+LS

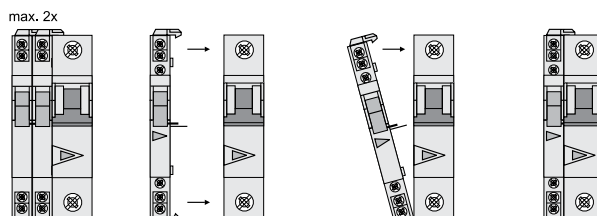

Example: ZP-NHK+LS



	For Protective Device	Type Designation	Article No.	Units per package
 <p>SG16011</p>	RCCB	Z-FAM	248293	1/60
 <p>SG16211</p>	RCBO	Z-KAM	248294	1/60

Description RCCB Tripping Module Z-FAM, Z-KAM

- For remote switch-off of RCCBs, standard and electronic combined RCD/MCB devices
- Remote switch-off by one or several parallel potential-free contacts, e.g. pushbutton max. rated current 3 A at 250 V, take into account maximum pushbutton voltage
- Remote tripping test by means of remote testing module Z-FW
- Can be mounted subsequently, to be wired according to connection diagram with the respective terminals of the RCCB
- No undesired voltage rise in the consumer system during remote switch-off thanks to integrated breaker contact K1-K2

Technical Data

	Z-FAM	Z-KAM
Electrical		
Classified according to	IEC 61373, EN 45545-2	
Current test marks as printed onto the device		
Rated voltage	230(400) V AC	230(400) V AC
Frequency	50/60 Hz	50/60 Hz
Rated tripping current	$I_{\Delta n}$ 0.01 - 0.3 A	0.01 - 0.3 A
Function	1NO	1NO
Mechanical		
Tripping module for	RCCB	RCBO
Frame size	45 mm	45 mm
Device height	80 mm	80 mm
Device width	8.8 mm (0.5MU)	8.8 mm (0.5MU)
Degree of protection, built-in	IP40	IP40
Terminal protection	finger and hand touch safe according to DGUV VS3, EN 50274	
Terminal capacity	1 - 2x2.5 mm ²	1 - 2x2.5 mm ²

Connection diagram

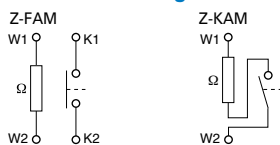

Dimensions (mm)

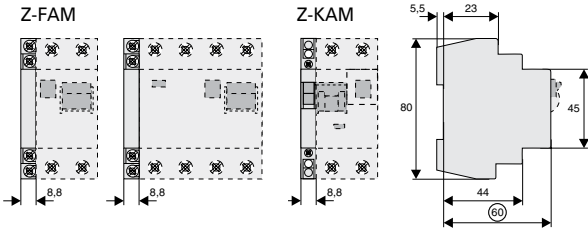

Connection examples: Lay lines to the switching devices with double insulation and overload protection, e.g. 4A gL or CLS6-4..-HS

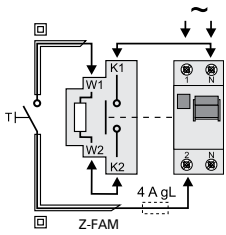

Connection diagram:
RCCB-2p, RCCB feed above

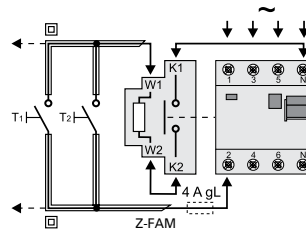

Connection diagram:
RCCB-4p, RCCB feed above

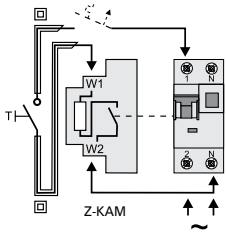

Connection diagram:
RCBO-2p, RCBO feed below

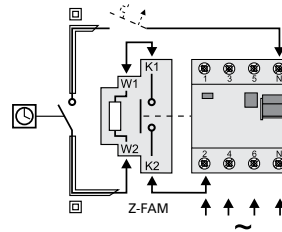

Connection diagram:
RCCB-4p, RCCB feed below

Poles	Rated Breaking Capacity (kA)	Type Designation	Article No.	Units per package
-------	------------------------------	------------------	-------------	-------------------

MCB for Auxiliary Switch Circuits PLSM-B4/-HS,

1	10	PLSM-B4-HS	247221	2 / 120
1+N	10	PLSM-B4/1N-HS	236722	2 / 80
2	10	PLSM-B4/2-HS	247222	1 / 60

SG54312



Description MCB for Auxiliary Switch Circuits PLSM-B4/-HS

- Design according to EN 60898-1, 4 A, Characteristic B
- Very low let-through energy in order to prevent contact welding in auxiliary switches of any and all switchgear, as well as thermostats control devices, timers, etc.
- Busbar connection to PFIM, PKN, ...

Technical Data

PLSM-B4/-HS	
Electrical	
Number of poles	1-, 1+N-, 2pole
Rated voltage	230/400 V
Frequency	50/60 Hz
Rated current	4 A
Rated breaking capacity	10 kA
Mechanical	
Frame size	45 mm
Device height	80 mm
Device width	17.5 mm (1MU) / 26.3 mm / 35 mm (2MU)
Mounting	quick fastening with 2 lock-in positions on DIN rail IEC/EN 60715
Degree of protection, built-in	IP40
Terminal protection	finger and hand touch safe according to DGVV VS3, EN 50274
Terminals	Twin-purpose terminals
Terminal capacity	1-25 mm ²
Terminal screws	M3 (Pozidrive)
Tightening torque of terminal screws	0.8-1.0 Nm
Busbar thickness	0.8 - 2 mm

Connection diagram

e.g. 1pole



Dimensions (mm)

PLSM-B4/-HS

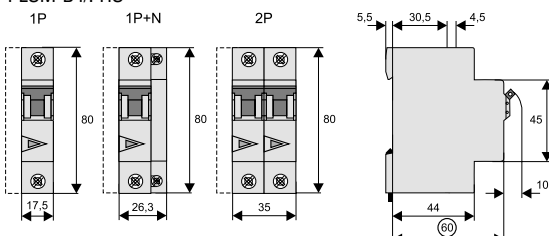

Let-through Energy PLSM-B4-HS, Characteristic B, 1pole

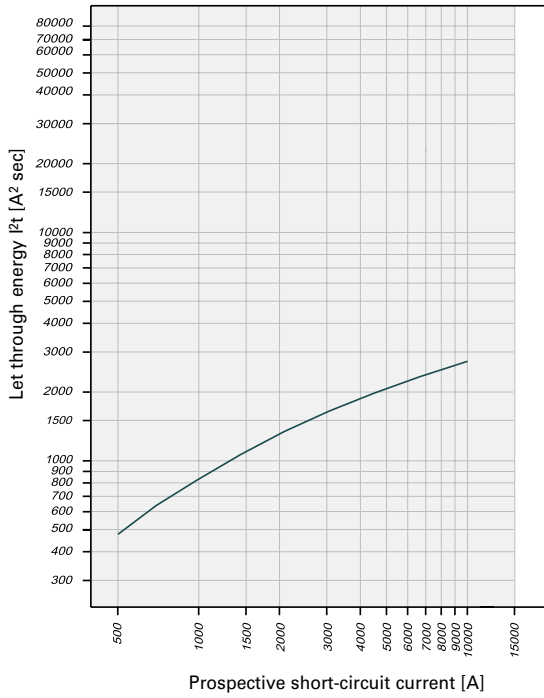

Practical Hint

Even auxiliary switches must be protected against overload and short circuit by means of suitable back-up fuses according to manufacturer specification. According to IEC 60947-5 a maximum back-up fuse is specified for conditional short circuit prevention up to 1,000 A. Therefore, connection of the auxiliary switch to the nearest MCB is not permitted. Danger of contact welding! The MCB for auxiliary switch circuits ...-HS offers a simple solution.

2.320 Accessories for Protective Devices

Shunt Trip Release Z-ASA, ZP-ASA

Operational voltage range (V~)	Type Designation	Article No.	Units per package
--------------------------------	------------------	-------------	-------------------

To be glued on

SG00712



12-110	Z-ASA/24	248286	1/60
110-415	Z-ASA/230	248287	1/60

To be snapped on

SG00212



12-110	ZP-ASA/24	248438	1/60
110-415	ZP-ASA/230	248439	1/60

Description Shunt Trip Release Z-ASA, ZP-ASA

- Remote release for subsequent mounting onto PXL, PLI, PXK, FAZ, FRBmM-1N, Z-MS
- Module width 1MU
- Additional installation of standard auxiliary switch is possible
- Position indicator red - green
- Type ZP-ASA for snap-on mounting

Technical Data

	Z-ASA24	Z-ASA230	ZP-ASA24	ZP-ASA230
Electrical				
Classified according to	IEC 61373, EN 45545-2			
Current test marks as printed onto the device				
Minimum pulse duration	15 ms	10 ms	15 ms	10 ms
Internal resistance	2,2 Ω	215 Ω	2,2 Ω	215 Ω
Duty cycle	100%	100%	100%	100%
Tripping time	< 20 ms	< 20 ms	< 20 ms	< 20 ms
Rated peak withstand voltage (1.2/50μs)	2.5 kV	2.5 kV	2.5 kV	2.5 kV
Endurance	>4000 operating cycles	>4000 operating cycles	>4000 operating cycles	>4000 operating cycles
AC voltage range				
Operating limit	10 V	60 V	10 V	60 V
Operational voltage range	12-110 V	110-415 V	12-110 V	110-415 V
Maximum current consumption during switch-on	15 A	2.1 A	15 A	2.1 A
Current flow time at max. current consumption	10 ms	10 ms	10 ms	10 ms
DC voltage range				
Operating limit	9 V	72 V	9 V	72 V
Operational voltage range	10-60 V	110-220 V	10-60 V	110-220 V
Maximum current consumption during switch-on	21 A	1 A	21 A	1 A
Current flow time at max. current consumption	2 ms	2 ms	2 ms	2 ms
Mechanical				
Frame size	45 mm	45 mm	45 mm	45 mm
Device height	80 mm	80 mm	80 mm	80 mm
Device width	17.5 mm (1MU)	17.5 mm (1MU)	17.5 mm (1MU)	17.5 mm (1MU)
Mounting	bonding	bonding	aufschnappen	aufschnappen
Degree of protection, built-in	IP40	IP40	IP40	IP40
Terminals above/below	open mouthed/lift	open mouthed/lift	open mouthed/lift with guide	open mouthed/lift with guide
Terminal capacity	1-25 mm ²	1-25 mm ²	1-25 mm ²	1-25 mm ²
Fastening torque of terminal screws	max. 2.4 Nm	max. 2.4 Nm	max. 2.4 Nm	max. 2.4 Nm

Connection diagram

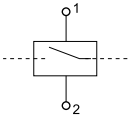

Dimensions (mm)

Z-ASA

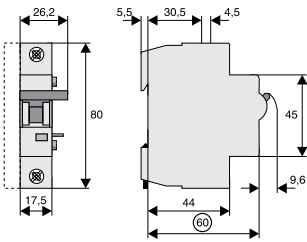

ZP-ASA

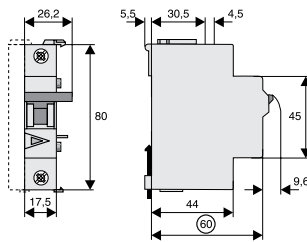

Connection Example 230 V

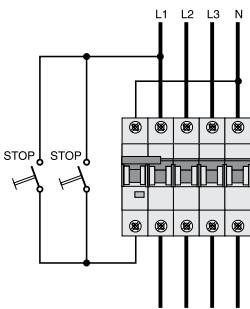

Connection Example 24 V

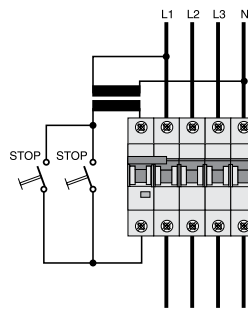

Example: Z-ASA + LS

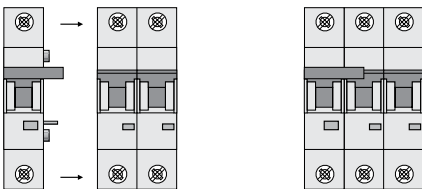

Example: ZP-ASA + LS

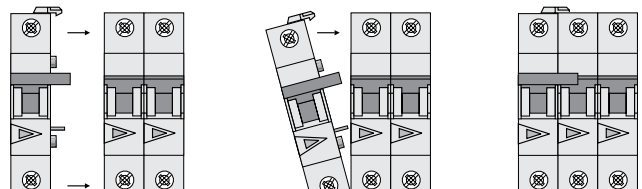

2.322 Accessories for Protective Devices

Undervoltage Release Z-USA, Z-USD

Operational voltage range (V~)	Function	Type Designation	Article No.	Units per package
--------------------------------	----------	------------------	-------------	-------------------

To be screwed on

SG78811



115	undelayed	Z-USA/115	248288	1/60
230	undelayed	Z-USA/230	248289	1/60
400	undelayed	Z-USA/400	248290	1/60
115	delayed 0.4s	Z-USD/115	248292	1/60
230	delayed 0.4s	Z-USD/230	248291	1/60

Description Undervoltage Release Z-USA, Z-USD

- Tripping:
 - Instantaneous Z-USA
 - Delayed Z-USD, typ. 0.4 s
- Voltage control indicator blue/white
- Service key for zero voltage switch-on for testing purposes
- Can be used with PXL, PLI, PXK, FAZ

Technical Data

	Z-US./115	Z-US./230	Z-US./400
Electrical			
Classified according to	IEC 61373, EN 45545-2		
Current test marks as printed onto the device			
Rated voltage	U_n 115 V AC	230 V AC	400 V AC
Frequency	50/60 Hz	50/60 Hz	50/60 Hz
Making threshold	80% of U_n	80% of U_n	80% of U_n
Tripping threshold	30% of U_n	30% of U_n	30% of U_n
Mechanical			
Frame size	45 mm	45 mm	45 mm
Device height	80 mm	80 mm	80 mm
Device width	17.5 mm (1MU)	17.5 mm (1MU)	17.5 mm (1MU)
Mounting	quick fastening on DIN rail IEC/EN 60715		
Degree of protection, built-in	IP40	IP40	IP40
Terminal protection	finger and hand touch safe according to DGUV VS3, EN 50274		
Terminals	open mouthed/lift	open mouthed/lift	open mouthed/lift
Terminal capacity	1 - 2x2.5 mm ²	1 - 2x2.5 mm ²	1 - 2x2.5 mm ²

Connection diagram

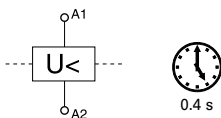

Dimensions (mm)

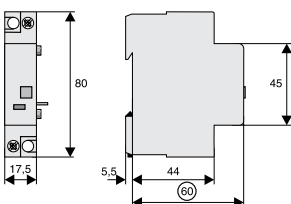

Connection Example Release

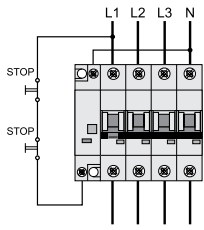

Connection Example 400V and 230V

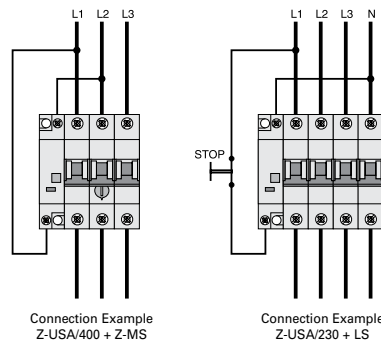

2.324 Accessories for Protective Devices

Switching Interlock IS/SPE-1TE, Z-IS/SPE-1TE

	Description	Type Designation	Article No.	Units per package
	PHASE OUT Switching interlock without lock for Isolators, RCDs, combined RCD/MCBs, ...	IS/SPE-1TE	101911	5/30
	Switching interlock without lock for MCBs and Circuit Breaker ZP-A	Z-IS/SPE-1TE	274418	5/30

Description Switching Interlock IS/SPE-1TE, Z-IS/SPE-1TE

- without lock

Type IS/SPE-1TE:

- for Isolators, RCDs, combined RCD/MCBs, ...

Type Z-IS/SPE-1TE:

- for MCBs
- maximum usable diameter of the padlock: 4-5 mm

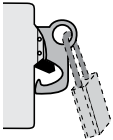

Operational voltage range (V-)

Type Designation

Article No. Units per package

Shunt Trip Release Kit Z-BHASA

SG09411



110-415	Z-BHASA/230	248445	8
12-60	Z-BHASA/24	248444	8

Description Shunt Trip Release Kit Z-BHASA

- Can be mounted subsequently
- Contact position indicator red - green
- Wide operational voltage range
- Sufficient power of extra low voltage source must be ensured FBHmV-ASA/24: min. 90 VA
- Screws for mounting included FBHmV => Z-BHASA => AZ

Technical Data

	Z-BHASA/24	Z-BHASA/230
Electrical		
Classified according to	IEC 61373, EN 45545-2	
Current test marks as printed onto the device		
Minimum pulse duration	15 ms	10 ms
Internal resistance	2 Ω	130 Ω
Duty cycle	100%	100%
Tripping time	< 20 ms	< 20 ms
Rated peak withstand voltage (1.2/50µs)	2 kV	2 kV
Endurance	>4000 operating cycles	>4000 operating cycles
AC voltage range		
Operating limit	8 V	70 V
Operational voltage range	12-60 V	110-415 V
Maximum current consumption during switch-on	14 A	3.4 A
Current flow time at max. current consumption	4.0 ms	4.0 ms
DC voltage range		
Operating limit	11 V	90 V
Operational voltage range	12-60 V	110-230 V
Maximum current consumption during switch-on	23.5 A typ.	1.7 A typ.
Current flow time at max. current consumption	2 ms	4 ms
Mechanical		
Frame size	45 mm	45 mm
Device height	90 mm	90 mm
Device width	27 mm	27 mm
Mounting	quick fastening on DIN rail IEC/EN 60715	
Degree of protection, built-in	IP40	IP40
Terminals above/below	Lift terminals	Lift terminals
Terminal capacity	2.5-30 mm ²	2.5-30 mm ²
Fastening torque of terminal screws	4 Nm	4 Nm

Connection diagram

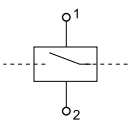

Dimensions (mm)

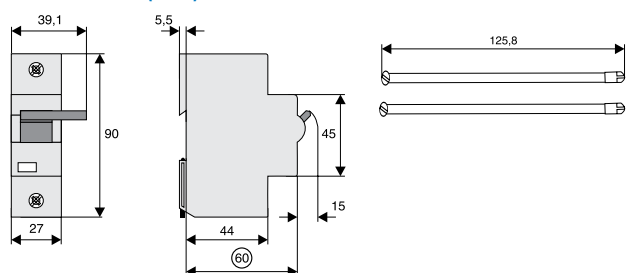

Operational voltage range (V-)

Type Designation

Article No. Units per package

Shunt Trip Release Z-LHASA

SG09311



110-415	Z-LHASA/230	248442	8
12-60	Z-LHASA/24	248441	8

Description Shunt Trip Release Z-LHASA

- Can be mounted subsequently
- Contact position indicator red - green
- Wide operational voltage range
- Sufficient power of extra low voltage source must be ensured. Z-LHASA/24: min. 90 VA

Technical Data

	Z-LHASA/24	Z-LHASA/230
Electrical		
Classified according to	IEC 61373, EN 45545-2	
Current test marks as printed onto the device		
Minimum pulse duration	15 ms	10 ms
Internal resistance	2 Ω	130 Ω
Duty cycle	100%	100%
Tripping time	< 20 ms	< 20 ms
Rated peak withstand voltage (1.2/50µs)	2 kV	2 kV
Endurance	>4000 operating cycles	>4000 operating cycles
AC voltage range		
Operating limit	8 V	70 V
Operational voltage range	12-60 V	110-415 V
Maximum current consumption during switch-on	14 A	3.4 A
Current flow time at max. current consumption	4.0 ms	4.0 ms
DC voltage range		
Operating limit	11 V	90 V
Operational voltage range	12-60 V	110-230 V
Maximum current consumption during switch-on	23.5 A typ.	1.7 A typ.
Current flow time at max. current consumption	2 ms	4 ms
Mechanical		
Frame size	45 mm	45 mm
Device height	90 mm	90 mm
Device width	27 mm	27 mm
Mounting	quick fastening on DIN rail IEC/EN 60715	
Degree of protection, built-in	IP40	IP40
Terminals above/below	Lift terminals	Lift terminals
Terminal capacity	2.5-30 mm ²	2.5-30 mm ²
Fastening torque of terminal screws	4 Nm	4 Nm

Connection diagram

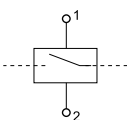

Dimensions (mm)

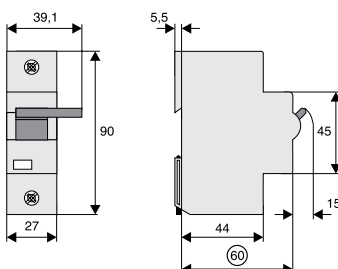

Function	Type Designation	Article No.	Units per package
Auxiliary Switch Z-LHK			
1NO+1NC	Z-LHK	248440	10/100

SG16111



Description Auxiliary Switch Z-LHK

- Auxiliary switch according to IEC 947-5-1
- Can be mounted subsequently

Technical Data

		Z-LHK
Electrical		
Classified according to		IEC 61373, EN 45545-2
Current test marks as printed onto the device		
Contact function		1NO + 1NC
Rated voltage		250 V
Frequency		50/60 Hz
Rated current		8 A
Rated thermal current	I_{th}	8 A
Utilisation category AC13		
Rated operational current	I_e	6 A / 250 V AC 2 A / 440 V AC
Utilisation category AC15		
Rated operational current	I_e	–
Utilisation category DC12		
Rated operational current	I_e	–
Utilisation category DC13		
Rated operational current	I_e	0.5 A / 230 V DC 2 A / 110 V DC 4 A / 60 V DC
Rated insulation voltage	U_i	250 V AC
Minimum operational voltage per contact	U_{min}	24 V AC/DC
Minimum operational current	I_{min}	50 mA AC/DC
Rated impulse withstand voltage (1,2/50µ)	U_{imp}	2.5 kV
Conditional short circuit current with back-up fuse 6 A or FAZ-B4-HS		1 kA
Max. back-up fuse, overload and short circuit		6 A gL / FAZ-4/.. /B-HS
Mechanical		
Can be mounted from the left onto		AZ
Can be mounted from the right onto		–
Tripping indicator “electrical tripping”		–
Frame size		45 mm
Device height		80 mm
Device width		8.8 mm (0.5MU)
Mounting		onto switching device
Degree of protection, built-in		IP40
Terminal protection		finger and hand touch safe according to DGUV VS3, EN 50274
Terminals		Lift terminals
Terminal capacity		0.5-2.5 mm ²
Terminal screws		M3.5 (Pozidrive Z2)
Fastening torque of terminal screws		max. 0.8-1.0 Nm

Connection diagram

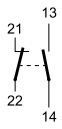

Dimensions (mm)

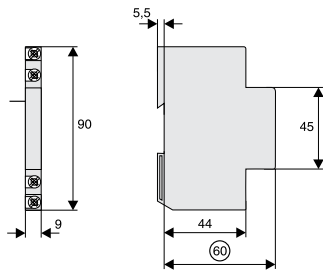

Function	Type Designation	Article No.	Units per package
----------	------------------	-------------	-------------------

Switching Interlock LH-SP

SG02214



Switching interlock	LH-SPL	285752	1
---------------------	--------	--------	---

SG01014



Switching interlock	LHSP-E	215999	1
---------------------	--------	--------	---

SG01114



Switchoff interlock	LHSP-A	216000	1
---------------------	--------	--------	---

Description Switching Interlock LHSP-E, LH-SPL

- Prevents undesired switching ON or OFF

Description Switchoff interlock LHSP-A

- Prevents undesired switch-OFF

Dimensions (mm)

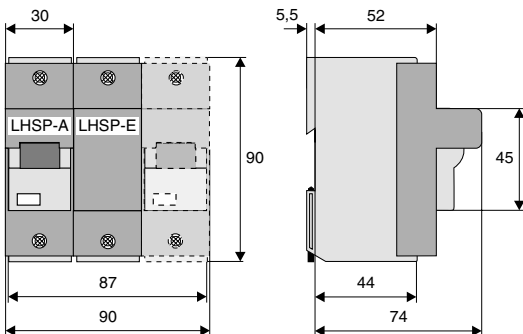

Operational voltage range V-

Type
Designation

Article No.

Units per
package**Auxiliary Switch Z-IHK-NA**

SG60711



250

Z-IHK-NA

113895

1

Description Auxiliary Switch Z-IHK-NA

- Design according to IEC/EN 60947-5-1, IEC/EN 62019
- Field installable
- The specified minimum voltages are per contact—take into account particularly in case of series connection
- Self-cleaning contacts
- Contact material and design particularly suitable for extra low voltage
- Tripping signal contact transmits message of electric tripping, not mechanical switch-off
- Test key for contact function “electrical tripping”
- Will allow for > 480Y/277 VAC rating

Technical Data

		Z-IHK-NA
Electrical		
Classified according to		IEC 61373, EN 45545-2
Current test marks as printed onto the device		
Contact function		1NO + 1NC
Rated voltage		250 V
Rated current		6 A
Rated thermal current	I_{th}	6 A
Utilisation category AC13		
Rated operational current	I_e	3 A / 250 V AC
Utilisation category AC15		
Rated operational current	I_e	2 A / 250 V AC
Utilisation category DC12		
Rated operational current	I_e	0.5 A / 110 V DC 0.25 A / 220 VDC
Rated insulation voltage	U_i	250 V AC
Minimum operational voltage per contact	U_{min}	5 V DC
Minimum operational current	I_{min}	10 mA AC/DC
Rated impulse withstand voltage (1,2/50 μ)	U_{imp}	4 kV
Conditional short circuit current with back-up fuse 6 A or FAZ-B4-HS		1 kA
Max. back-up fuse, overload and short circuit		6 A gL / FAZ-4/.../B-HS
Mechanical		
Tripping indicator “electrical tripping”		–
Frame size		45 mm
Device height		80 mm
Device width		8.8 mm (0.5MU)
Mounting		onto switching device
Degree of protection, built-in		IP40
Terminal protection		finger and hand touch safe according to DGUV VS3, EN 50274
Terminals		Lift terminals
Terminal capacity		0.5-2.5 mm ²
Terminal screws		M4 (Pozidrive Z2)
Fastening torque of terminal screws		max. 1.2 Nm

Connection diagram

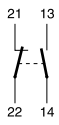

Dimensions (mm)

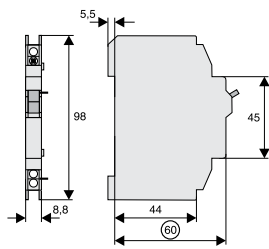

Operational voltage range

Type
Designation

Article No.

Units per
package**Shunt Trip Release FAZ-XAA-NA**

SG13511



12–110 V AC, 12–60 V DC	FAZ-XAA-NA12-110VAC	102037	1
110–415 V AC, 110–230 V DC	FAZ-XAA-NA110-415VAC	102036	1

Description Shunt Trip Release FAZ-XAA-NA

- Remote release for subsequent mounting onto FAZ-NA
- Additional installation of standard auxiliary switch is possible
- Position indicator red–green

Technical Data

	FAZ-XAA-NA12-110VAC	FAZ-XAA-NA110-415VAC
Electrical		
Classified according to	IEC 61373, EN 45545-2	
Current test marks as printed onto the device		
Can be mounted onto	FAZ-NA / FAZ-NA-DC / FAZ-RT	FAZ-NA / FAZ-NA-DC / FAZ-RT
Operational voltage range	12–110 V AC 12–60 V DC	110–415 V AC 110–230 V DC
Frequency	50/60 Hz	50/60 Hz
Function	1NO	1NO
Mechanical		
Frame size	45 mm	45 mm
Device height	105 mm	105 mm
Device width	17.5 mm	17.5 mm
Mounting	Quick fastening with two lock-in positions on EN 50022	
Degree of protection, built-in	IP40	IP40
Terminal protection	finger and hand touch safe according to DGUV VS3, EN 50274	
Terminals	open mouthed/lift	open mouthed/lift
Terminal capacity, one and two wires	18–10 AWG	18–10 AWG

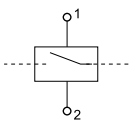
Connection diagram

Description	Type Designation	Article No.	Units per package
-------------	------------------	-------------	-------------------

Terminal Covers for RCDs

SG82011

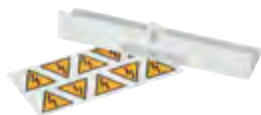

2-poles	Z-RC/AK-2TE	285385	10
4-poles	Z-RC/AK-4TE	101062	10

Terminal Covers for Add-on Device

SG02614



2-poles	Z-TC/AO-2P	178097	10
3+4-poles	Z-TC/AO-3-4P	178098	10

Terminal Covers for MCB, RCBO

SG02314



2-poles	Z-TC/SD-2P	178099	10
3-poles	Z-TC/SD-3P	178100	10
4-poles	Z-TC/SD-4P	178101	10

Terminal Cover for MCBs

1-pole	Z-TC/MCB-1P	178102	10
--------	-------------	--------	----

2.334 Accessories for Protective Devices

Remote Control and Automatic Switching Device Z-FW

Function	Type Designation	Article No.	Units per package
----------	------------------	-------------	-------------------

Remote Control Device Z-FW

SG30811



Automatic restarting 230VAC	Z-FW-LP	248296	1/20
Automatic restarting 24-48VDC	Z-FW-LPD	265244	1/20

SG30711



+ Remote control module ON/OFF/TEST (only in connection with Z-FW-LP, -LPD from delivery date 2006!)	Z-FW-MO	284730	1
---	---------	--------	---

Operational voltage range	Type Designation	Article No.	Units per package
---------------------------	------------------	-------------	-------------------

Pre-mounted sets Z-FW

Automatic restoring + remote control

SG31311



230 VAC	Z-FW-LP/MO	290171	1/12
24-48 VDC	Z-FW-LPD/MO	290172	1/12

Remote control

230 VAC	Z-FW-LPE/MO	108104	1/12
24-48 VDC	Z-FW-LPS/MO	100052	1/12

Rated Fault Current	Type Designation	Article No.	Units per package
---------------------	------------------	-------------	-------------------

Remote Testing Module Z-FW

- for Z-FW-LP./MO set use only

SG12111



0.01 A	Z-FW/001	248297	4/120
0.03 A	Z-FW/003	248298	4/120
0.1 A	Z-FW/010	248299	4/120
0.3 A	Z-FW/030	248300	4/120
0.5 A	Z-FW/050	248301	4/120

Description Remote Testing Module and Remote Control Device Z-FW

- Shape compatible switching device suitable for subsequent installation for automatic re-setting and remote control of MCBs, RCCBs and Z-MS
- Mechanical interlock, can be sealed with leads
- Mechanical switching capability up to max. RCCB-100/4p, MCB-100/4p
- Operating and alarm display by green and red LED
- Function extension with Switching Modul Z-FW-MO
Operating and trouble display by LED pre-assembled only with Z-FW...

Technical Data

	Z-FW-LP	Z-FW-LPD	Z-FW-MO
Electrical			
Possible operating voltages	220-240 V AC	24-48 V DC	–
Frequency	50/60 Hz	–	–
Testing module (0.5MU) for remote testing of RCDs	Z-FW...	Z-FW...	–
Control voltage for remote control	–	–	24-230 V AC/DC
Relay output for tripping test with Z-FW	–	–	400 V AC max.
Relay output for alarm, potential-free	5 A / 250 V AC	5 A / 250 V AC	–
Functions	Automatic restarting	Automatic restarting	+ON/OFF/TEST
Function selector	Automatic 5x, OFF/RESET	Automatic 5x, OFF/RESET	ON, OFF/RESET
Remote control function via telephone with Telecommander	–	–	–
Mechanical			
Frame size	45 mm	45 mm	45 mm
Device height	80 mm	80 mm	80 mm
Device width	70 mm	70 mm	35 mm
Mounting	quick fastening with 2 lock-in positions on DIN rail IEC/EN 60715	–	–
Degree of protection, built-in	IP40	IP40	IP40
Terminal protection	finger and hand touch safe according to DGUV VS3, EN 50274	–	–
Terminals	Lift terminals	Lift terminals	Lift terminals
Terminal capacity	2 x 1.5 mm ² or 1 x 2.5 mm ²	2 x 1.5 mm ² or 1 x 2.5 mm ²	4 x 1,5 mm ² or 2 x 2.5 mm ²
Scope of delivery	–	–	Coupling plug

Connection diagram

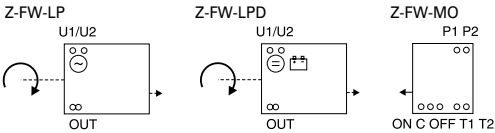

Dimensions (mm)

Z-FW-LP, -LPD, -LPE, -LPS

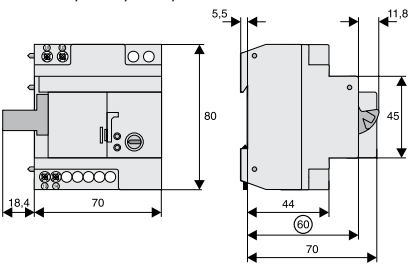

Z-FW-MO

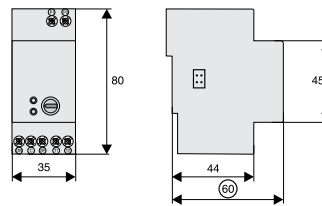

Connection Example

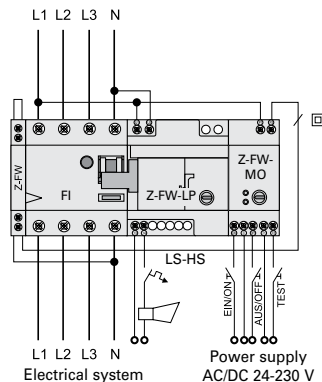
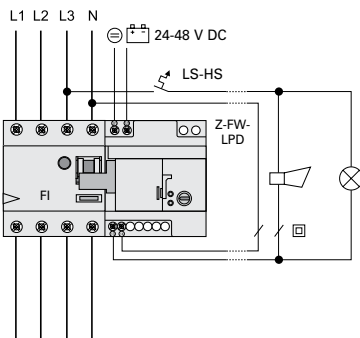

Description Remote Testing Module Z-FW (for Z-FW-LP)

- External testing module with testing resistor for RCDs
- Proper „external“ test key function according to the applicable rules thanks to design adapted to the rated tripping current
- For remote testing with remote control and automatic switching device Z-FW-LP
- No undesired voltage rise in the consumer system during remote switch-off thanks to integrated breaker contact K1-K2
- Can also be used as a remote tripping module for RCDs

Technical Data

	Z-FW-LP/MO	Z-FW-LPD/MO	Z-FW-LPE/MO	Z-FW-LPS/MO
Electrical				
Possible operating voltages	220-240 V AC	24-48 V DC	220-240 V AC	24-48 V DC
Frequency	50/60 Hz	–	50/60 Hz	–
Testing module (0.5MU) for remote testing of RCDs	Z-FW...	Z-FW...	Z-FW...	Z-FW...
Control voltage for remote control	24-230 V AC/DC	24-230 V AC/DC	24-230 V AC/DC	24-230 V AC/DC
Relay output for tripping test with Z-FW	400 V AC max.	400 V AC max.	400 V AC max.	400 V AC max.
Relay output for alarm, potential-free	5 A / 250 V AC	5 A / 250 V AC	5 A / 250 V AC	5 A / 250 V AC
Functions	Automatic restoring + remote control	Automatic restoring + remote control	Remote control	Remote control
Mechanical				
Frame size	45 mm	45 mm	45 mm	45 mm
Device height	80 mm	80 mm	80 mm	80 mm
Device width	105 mm	105 mm	105 mm	105 mm
Mounting	quick fastening with 2 lock-in positions on DIN rail IEC/EN 60715			
Degree of protection, built-in	IP40	IP40	IP40	IP40
Terminal protection	finger and hand touch safe according to DGUV VS3, EN 50274			
Terminals	Lift terminals	Lift terminals	Lift terminals	Lift terminals

Dimensions (mm)

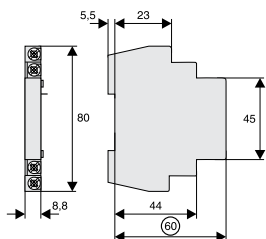

SG13113

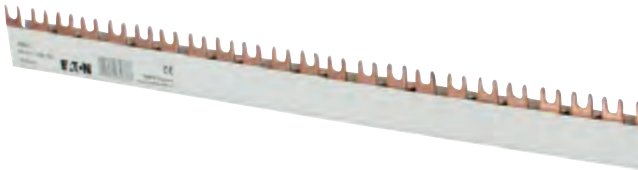

Description

Busbar System xEffect is the modular design system for busbars. xEffect busbars are available as yard goods with 1, 2 or 3 poles. Now, there is a special feature: each bar can easily be extended by one-pole bar as you like. The additional pole can be added completely without tools by easy clamping technique. The lugs or forks in the xEffect bars - available in 10 and 16 mm² and all common distances - can be broken out at a predetermined breaking point. There is actually no more flexibility available.

Busbar System xEffect saves time and material

The yard good can be cut with a saw of course. However, there is no need neither for deburring nor for cutting the conductor. Just cut to the required dimension and close with the fitting end cap -ready! The end caps have also breakable edges, which enable further connecting of the Busbar System xEffect. By overlapping assembly, doubling the cross section can be achieved.

Busbar System xEffect in use

Busbar System xEffect is especially well suited for solving flexible busbar applications rack-mounted models in series. Fork-pin combinations for 1+N-applications can be realized by individual combinations - for this also the one-pole version with blue isolation is available besides the one with grey isolation. Even different cross sections can be combined in this case.

Accessories, such as feeder terminals and self adhesive phase marking labels will complete the comfortable total package. Existing contact prevention caps can be used.

Busbar System xEffect at a glance:

- Yard goods can be cut
- No cutting back of copper required
- No deburring required
- Almost no waste during cutting
- End caps available with 1- to 4-poles, end caps can be broken out for further extensions
- 4-pole end cap molded in pairs (left and right)
- Overlapping rail extension possible

- Rails can be extended on demand by 1-pole rails (plug-in technology)
- All step distances
- 10 and 16 mm²
- Fork and stud
- Lugs can be broken out at any predetermined breaking point
- Self adhesive phase indication labels available
- Contact preventing caps (ZV-BS-G) can be used
- Simple, flexible handling
- All assembly requirements can be covered by the Busbar System xEffect
- Low storage space requirements due to modular system
- Less time consuming (no deburring, no cutting back)
- Individual and self configurable
- Fork-pin combination for 1+N application possible, feeding through rail (terminal clamp) not possible.
- Protected technology

Description	Step Distance (mm)	Cu-factor	Type Designation	Article No.	Units per package
-------------	--------------------	-----------	------------------	-------------	-------------------

For MCBs, RCCBs, RCBOs, SPDs

- Delivered without end caps

SG13113



10 mm², Rated current 63 A

1-phase	17.8	0.22	BB-EVF-10/1P-1MU	168826	10
	27	0.24	BB-EVF-10/1P-1,5MU	168830	10
	36	0.24	BB-EVF-10/1P-2MU	168834	10
2-phase	17.8	0.31	BB-EVF-10/2P-1MU	168838	10
	27	0.36	BB-EVF-10/2P-1,5MU	168840	10
	36	0.36	BB-EVF-10/2P-2MU	168842	10
3-phase	17.8	0.46	BB-EVF-10/3P-1MU	168842	10
	27	0.58	BB-EVF-10/3P-1,5MU	168844	10
	36	0.56	BB-EVF-10/3P-2MU	168850	10
3-phase + AUX	3x17.8+1x9	0.58	BB-EVF-10/3P-1MU/AUX	168846	10
	3x17.8+2x9	0.57	BB-EVF-10/3P-1MU/2AUX	168848	10
Neutral	17.8	0.22	BB-EVF-10/N-1MU	168828	10
	27	0.24	BB-EVF-10/N-1,5MU	168832	10
	36	0.24	BB-EVF-10/N-2MU	168836	10

SG13413

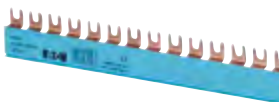

SG13213



16 mm², Rated current 80 A

1-phase	17.8	0.33	BB-EVF-16/1P-1MU	168827	10
	27	0.36	BB-EVF-16/1P-1,5MU	168831	10
	36	0.32	BB-EVF-16/1P-2MU	168835	10
2-phase	17.8	0.46	BB-EVF-16/2P-1MU	168839	10
	17.8	0.57	BB-EVF-16/2P-1MU/AUX	500526	10
	27	0.54	BB-EVF-16/2P-1,5MU	168841	10
3-phase	17.8	0.69	BB-EVF-16/3P-1MU	168843	10
	27	0.87	BB-EVF-16/3P-1,5MU	168845	10
	36	0.84	BB-EVF-16/3P-2MU	168851	10
3-phase + AUX	3x17.8+1x9	0.87	BB-EVF-16/3P-1MU/AUX	168847	10
	3x17.8+2x9	0.86	BB-EVF-16/3P-1MU/2AUX	168849	10
Neutral	17.8	0.33	BB-EVF-16/N-1MU	168829	10
	27	0.36	BB-EVF-16/N-1,5MU	168833	10
	36	0.32	BB-EVF-16/N-2MU	168837	10

SG13613



Description	Step Distance (mm)	Cu-factor	Type Designation	Article No.	Units per package
-------------	--------------------	-----------	------------------	-------------	-------------------

For MCBs, RCCBs, RCBOs, SPDs

- Delivered without end caps



10 mm², Rated current 63 A

1-phase	17.8	0.22	BB-EVP-10/1P-1MU	168852	10
	27	0.24	BB-EVP-10/1P-1,5MU	168856	10
	36	0.24	BB-EVP-10/1P-2MU	168860	10
2-phase	17.8	0.31	BB-EVP-10/2P-1MU	168864	10
	27	0.36	BB-EVP-10/2P-1,5MU	168866	10
3-phase	17.8	0.46	BB-EVP-10/3P-1MU	168868	10
	27	0.58	BB-EVP-10/3P-1,5MU	168870	10
	36	0.56	BB-EVP-10/3P-2MU	168876	10
3-phase + AUX	3x17.8+1x9	0.58	BB-EVP-10/3P-1MU/AUX	168872	10
	3x17.8+2x9	0.57	BB-EVP-10/3P-1MU/2AUX	168874	10
Neutral	17.8	0.22	BB-EVP-10/N-1MU	168854	10
	27	0.24	BB-EVP-10/N-1,5MU	168858	10
	36	0.24	BB-EVP-10/N-2MU	168862	10

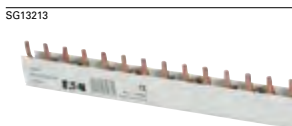
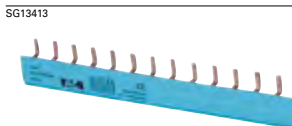

16 mm², Rated current 80 A

1-phase	17.8	0.33	BB-EVP-16/1P-1MU	168853	10
	27	0.36	BB-EVP-16/1P-1,5MU	168857	10
	36	0.32	BB-EVP-16/1P-2MU	168861	10
2-phase	17.8	0.46	BB-EVP-16/2P-1MU	168865	10
	27	0.54	BB-EVP-16/2P-1,5MU	168867	10
3-phase	17.8	0.69	BB-EVP-16/3P-1MU	168869	10
	27	0.87	BB-EVP-16/3P-1,5MU	168871	10
	36	0.84	BB-EVP-16/3P-2MU	168877	10
3-phase + AUX	3x17.8+1x9	0.87	BB-EVP-16/3P-1MU/AUX	168873	10
	3x17.8+2x9	0.86	BB-EVP-16/3P-1MU/2AUX	168875	10
Neutral	17.8	0.33	BB-EVP-16/N-1MU	168855	10
	27	0.36	BB-EVP-16/N-1,5MU	168859	10
	36	0.32	BB-EVP-16/N-2 MU	168863	10

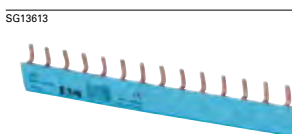

Accessories

End Caps BB-EV-EC



1-phase	-	-	BB-EV-EC/1P	168878	40
2+3-phase	-	-	BB-EV-EC/2-3P	168823	40
4-phase	-	-	BB-EV-EC/4P	168824	20
Neutral	-	-	BB-EV-EC/N	168879	20

Terminal BB-EV-MU/35



-	-	0.04	BB-EV-MU/35	168825	3
---	---	------	-------------	--------	---

Sticker Phase Sequence

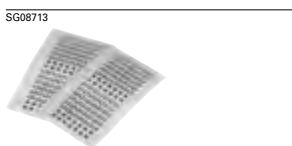

-	-	-	BB-S-PS	169831	5
---	---	---	---------	--------	---

Busbar Tag Shrouds ZV-BS-G

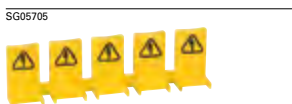

-	-	-	ZV-BS-G	104903	10/600
---	---	---	---------	--------	--------

Technical Data

		BB-EV.
General		
Heat deflection temperature		≥ 80°C UL94 V0
Standards		EN 60947-1:2007 / IEC 60947-1:2007 / IEC 60999:2000
Climate stability		according to DIN EN 60068
Insulation coordination		Overvoltage category III / Pollution degree 2
Electrical		
Impulse voltage strenght		≥ 4.5 kV
Min. air distance		>5.5 mm
Min. creeping distance		>5 mm
Max. operating voltage		690 V AC/DC 1,000 V DC 1-pole only
Max. busbar current	I_s /Phase	
10 mm ²		63 A
16 mm ²		80 A
Protection class		IP20
Short circuit rating	I_{cc}	25 kA - NH3 355A, gC500V JM
Dielectric strenght		PC - ABS >32 kV / mm

Assembly instruction:

Cutting

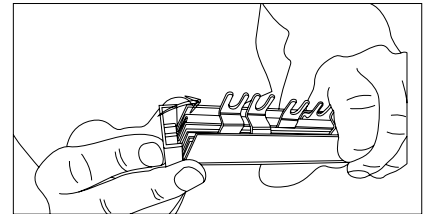
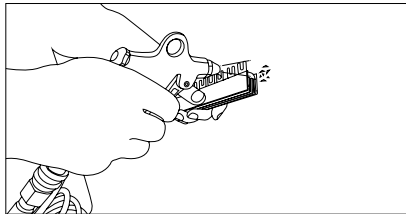
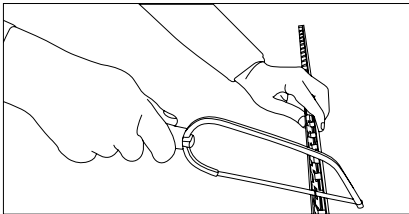

Mounting of an extension busbar

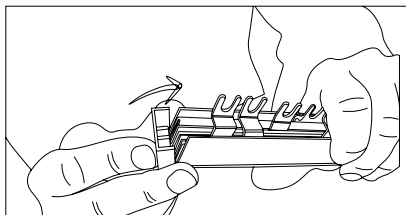
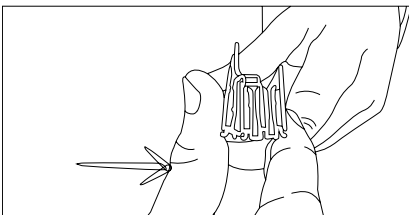
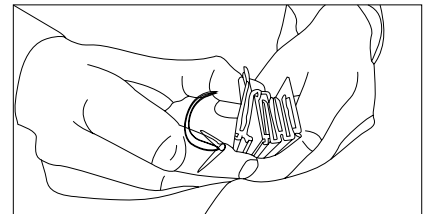
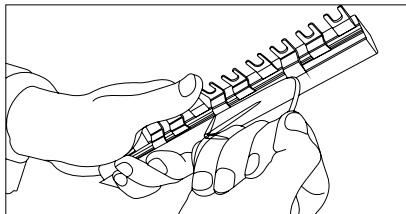
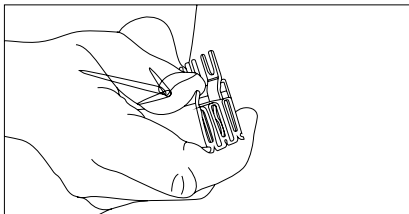

Overlapping mounting or further connection, resp.

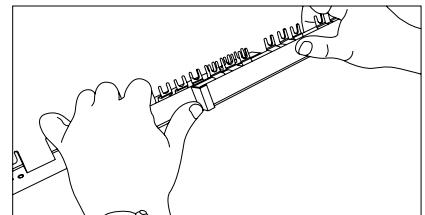
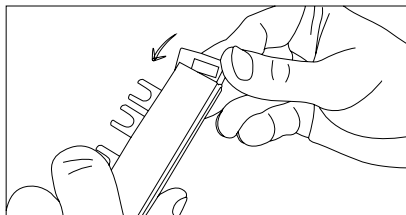
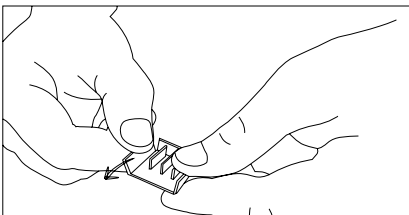

Breacking out of connection lugs

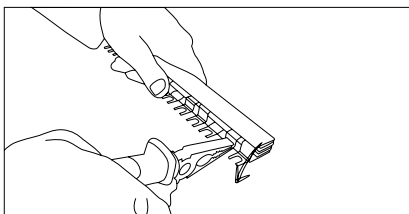

Sticking on phase marking

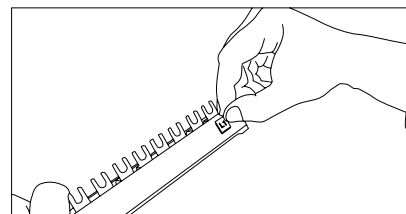

SG13713



Description

- For MCB FAZ-NA/RT
- Sliceable
- 18 and 25 mm²
- Pin busbar
- Accessories available:
 - End cap
 - Terminal
 - Busbar tag shrouds
- Length 1 m

Description	Step Distance (mm)	Cu-factor	Type Designation	Article No.	Units per package
-------------	--------------------	-----------	------------------	-------------	-------------------

For FAZ-NA/RT

- Delivered without end caps

SG13713



18 mm², Rated current 80 A

1-phase	17.6	0.39	Z-BB/UL18/1P1MU/57	171128	10
1-phase + AUX	26.4	0.378	Z-BB/UL18/1P1MU+AUX/37	171134	10
2x 1-phase + AUX	26.4	0.56	Z-BB/UL18/2X1P1MU+AUX/38	171142	10
3x 1-phase + AUX	26.4	0.945	Z-BB/UL18/3X1P1MU+AUX/39	171140	10
2-phase	17.6	0.625	Z-BB/UL18/2P1MU/56	171129	10
2-phase + AUX	17.6 + 26.4	0.625	Z-BB/UL18/2P1MU+AUX/46	171135	10
3-phase	17.6	0.95	Z-BB/UL18/3P1MU/57	171130	10
3-phase + AUX	2x 17.6 + 26.4	0.93	Z-BB/UL18/3P1MU+AUX/48	171136	10

SG14213



25 mm², Rated current 100 A

1-phase	17.6	0.535	Z-BB/UL25/1P1MU/57	171131	10
1-phase + AUX	26.4	0.745	Z-BB/UL25/1P1MU+AUX/37	171137	10
2x 1-phase + AUX	26.4	0.78	Z-BB/UL25/2X1P1MU+AUX/38	171143	10
3x 1-phase + AUX	26.4	1.315	Z-BB/UL25/3X1P1MU+AUX/39	171141	10
2-phase	17.6	0.888	Z-BB/UL25/2P1MU/56	171132	10
2-phase + AUX	17.6 + 26.4	0.87	Z-BB/UL25/2P1MU+AUX/46	171138	10
3-phase	17.6	1.31	Z-BB/UL25/3P1MU/57	171133	10
3-phase + AUX	2x 17.6 + 26.4	1.28	Z-BB/UL25/3P1MU+AUX/48	171139	10

Accessories

End Cap Z-ECUL

SG02514

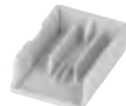

-	-	-	Z-ECUL	171145	10
---	---	---	--------	--------	----

Terminal Z-MUUL35

SG03014



-	-	0.038	Z-MUUL35	171144	10
---	---	-------	----------	--------	----









Busbar Tag Shrouds Z-FPUL

SG08613



-	-	-	Z-FPUL	171146	10
---	---	---	--------	--------	----

Description of the Busbar UL489 Z-BB/UL for FAZ-NA, -RT

									
Z-BB/UL18/1P1MU/57	171128	57	-	-	-	-	-	-	-
Z-BB/UL18/2P1MU/56	171129	-	56	-	-	-	-	-	-
Z-BB/UL18/3P1MU/57	171130	-	-	57	-	-	-	-	-
Z-BB/UL25/1P1MU/57	171131	57	-	-	-	-	-	-	-
Z-BB/UL25/2P1MU/56	171132	-	56	-	-	-	-	-	-
Z-BB/UL25/3P1MU/57	171133	-	-	57	-	-	-	-	-
Z-BB/UL18/1P1MU+AUX/37	171134	-	-	-	37	-	-	-	-
Z-BB/UL18/2P1MU+AUX/46	171135	-	-	-	-	-	-	46	-
Z-BB/UL18/3P1MU+AUX/48	171136	-	-	-	-	-	-	-	48
Z-BB/UL25/1P1MU+AUX/37	171137	-	-	-	37	-	-	-	-
Z-BB/UL25/2P1MU+AUX/46	171138	-	-	-	-	-	-	46	-
Z-BB/UL25/3P1MU+AUX/48	171139	-	-	-	-	-	-	-	48
Z-BB/UL18/3X1MU+AUX/39	171140	-	-	-	-	-	39	-	-
Z-BB/UL25/3X1MU+AUX/39	171141	-	-	-	-	-	39	-	-
Z-BB/UL18/2X1MU+AUX/38	171142	-	-	-	-	38	-	-	-
Z-BB/UL25/2X1MU+AUX/38	171143	-	-	-	-	38	-	-	-
Z-TEUL35	171144	-	-	-	-	-	-	-	-
Z-ECUL	171145	-	-	-	-	-	-	-	-
Z-FPUL	171146	-	-	-	-	-	-	-	-

Technical Data

Z-BB/UL	
General	
Heat deflection temperature	>100°C - UL94 V0
Standards	UL489, EN 60947-1, IEC 60947-1:2004
Climate stability	according to DIN EN 60068
Insulation coordination	Overvoltage category III / Pollution degree 2
Electrical	
Impulse voltage strenght	≥ 10 kV
Min. air distance	≥ 1" ext.
Min. creeping distance	≥ 2" ext.
Max. operating voltage	
1-pole	1.000 V AC/DC
2-, 3-poles	600 V AC/DC
Max. busbar current	I _s /Phase
18 mm ²	80 A
25 mm ²	100 A
Protection class	IP20
Short circuit rating	I _{cc} 10 kA
Dielectric strenght	PA66-V0, >35 kV

Mounting example of busbar UL489 Z-BB/UL for FAZ-NA, -RT

Z-BB/UL18/XX
Z-BB/UL25/XX

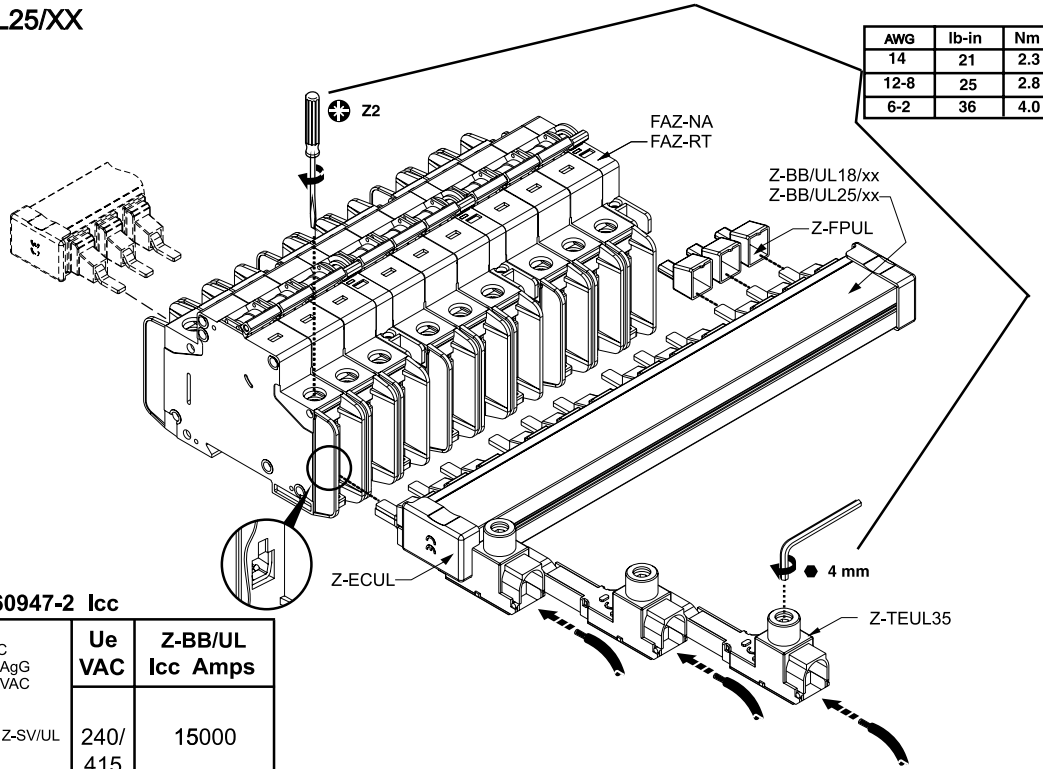

IEC/EN 60947-2 Icc

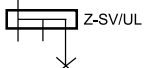
Ue HRC 315AgG 500VAC	Ue VAC	Z-BB/UL Icc Amps
 Z-SV/UL	240/	15000
	415	

UL SCCR

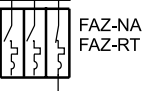
Ue Z-SV/UL	FAZ-NA FAZ-RT In Amps	Ue VAC	Z-BB/UL SCCR RMS Sym Amps
 FAZ-NA FAZ-RT	0.5-32	480Y/ 277	10000
	35-40	240	10000

SG01914



Description

- For MCB FAZ
- Sliceable
- 18 and 25 mm²
- Pin busbar
- Accessories available:
 - End caps
 - Terminals
 - Busbar tag shrouds
- Length 1 m

Description	Step Distance (mm)	Cu-factor	Type Designation	Article No.	Units per package
-------------	--------------------	-----------	------------------	-------------	-------------------

For FAZ

- Delivered without end caps

SG01914



18 mm², Rated current 80 A

1-phase	17.8	0.33	BB-UL-18/1P-1M/57	121981	10
2-phase	17.8	0.508	BB-UL-18/2P-2M/56	121982	10
3-phase	17.8	0.8	BB-UL-18/3P-3M/57	121983	10
1-phase + AUX	27	0.33	BB-UL-18/1P-1,5M/37	121984	10
2-phase + AUX	17.8 + 26.7	0.52	BB-UL-18/2P+AS-2,5M/46	121987	10
3-phase + AUX	2x 17.8 + 26.7	0.8	BB-UL-18/3P+AS-3,5M/48	121988	10

SG01814



25 mm², Rated current 100 A

1-phase	17.8	0.45	BB-UL-25/1P-1M/57	121989	10
2-phase	17.8	0.68	BB-UL-25/2P-2M/56	121990	10
3-phase	17.8	1.07	BB-UL-25/3P-3M/57	121991	10
1-phase + AUX	27	0.45	BB-UL-25/1P-1,5M/37	121992	10
2-phase + AUX	17.8 + 26.7	0.69	BB-UL-25/2P+AS-2,5M/46	121995	10
3-phase + AUX	2x 17.8 + 26.7	1.03	BB-UL-25/3P+AS-3,5M/48	121996	10

Accessories

End Caps BB-UL-EC

SG02114



1-phase	-	-	BB-UL-EC/1	122000	10
3-phase	-	-	BB-UL-EC/3	122001	10

Terminals BB-UL-TE

SG00113



6 - 35mm ² (single and multi wire)	0.035		BB-UL-TEP/35	121997	10
6 - 50mm ²	0.038		BB-UL-TEPA/35	169823	10
6 - 50mm ² (single and multi wire)	0.038		BB-UL-TE/50	121998	10







Busbar Tag Shrouds BB-IP/5

SG05705

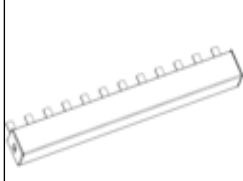

for 5 pins	-	-	BB-IP/5	121999	10
------------	---	---	---------	--------	----

Description of the Busbar UL508 BB-UL for FAZ



							
Article No.							
121981	BB-UL-18/1P-1M/57	57	-	-	-	-	-
121982	BB-UL-18/2P-2M/56	-	28	-	-	-	-
121983	BB-UL-18/3P-3M/57	-	-	19	-	-	-
121984	BB-UL-18/1P-1,5M/37	-	-	-	37	-	-
121987	BB-UL-18/2P+AS-2,5M/46	-	-	-	-	23	-
121988	BB-UL-18/3P+AS-3,5M/48	-	-	-	-	-	16
121989	BB-UL-25/1P-1M/57	57	-	-	-	-	-
121990	BB-UL-25/2P-2M/56	-	28	-	-	-	-
121991	BB-UL-25/3P-3M/57	-	-	19	-	-	-
121992	BB-UL-25/1P-1,5M/37	-	-	-	37	-	-
121995	BB-UL-25/2P+AS-2,5M/46	-	-	-	-	23	-
121996	BB-UL-25/3P+AS-3,5M/48	-	-	-	-	-	16
121997	BB-UL-TEP/35	-	-	-	-	-	-
169823	BB-UL-TEPA/35	-	-	-	-	-	-
121998	BB-UL-TE/50	-	-	-	-	-	-
121999	BB-IP/5	-	-	-	-	-	-
122000	BB-UL-EC/1	-	-	-	-	-	-
122001	BB-UL-EC/3	-	-	-	-	-	-

Technical Data

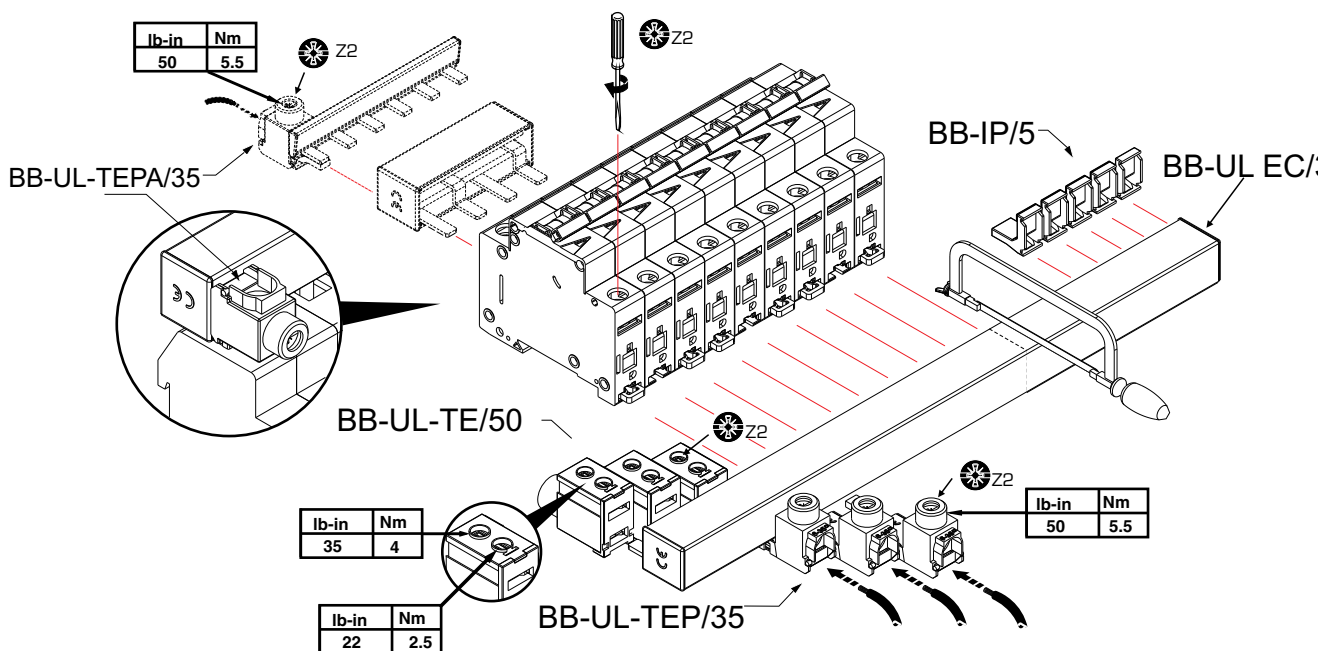

		BB-UL
General		
Heat deflection temperature	125°C - UL94 V0	
Standards	DIN EN 60947-2, VDE 0660 - 101 = IEC 60947-2, IEC 60999:2000, UL508, UL486A, CSA C22.2	
Climate stability	according to DIN EN 60068	
Insulation coordination	Overvoltage category III / Pollution degree 2	
Electrical		
Impulse voltage strenght	≥ 9.5 kV	
Min. air distance	> 9.5 mm	
Min. creeping distance	> 12.7 mm	
Max. operating voltage		
1-pole	1.000 V AC/DC	
2-, 3-poles	IEC/EN 690 V AC/DC 600 V AC/DC UL Fuse 480 V AC/DC UL-SP	
Max. busbar current	I _s /Phase	
18 mm ²		80 A
25 mm ²		100 A
Protection class	IP20	
Short circuit rating	10 kA 3 cycles @ 480 V / 100 kA Fuse Class J 175 A @ 18 mm ² - 200 A @ 25 mm ²	
Dielectric strenght	>32 kV/mm	

Mounting example of busbar UL508, BB-UL for FAZ

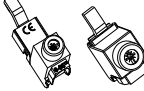

BB-UL-TE/50		
	UL508	EN/IEC 60947-2
U_e	480 V AC	240/690V AC
f	50/60 Hz	50/60 Hz
I_e	115 A @ 40°C	160 A @ 30°C
	#1-14 AWG 60/75°C Cu	1.5–50 mm ² Cu
	0.56 in	14 mm

BB-UL		
	UL508	EN/IEC 60947-2
U_e	480 V AC	690V AC
f	50/60 Hz	
I_{pk}	10kA	15kA
I_e	18mm ²	25mm ²
Infeed at the start of the busbar	80A @ 40 °C	100A @ 30°C
Infeed at the center of the busbar	160A @ 40°C	200A @ 30°C

BB-UL-TEP/35 / BB-UL-TEPA/35		
	UL508	EN/IEC 60947-2
U_e	480 V AC	240/690V AC
f	50/60 Hz	50/60 Hz
I_e	115 A @ 40°C	80 A @ 30°C
	#2-14 AWG 60/75°C Cu	2.5–35 mm ² Cu
	0.56 in	14 mm

*-UL508 SHORT CIRCUIT RATINGS

- SUITABLE FOR USE ON A CIRCUIT CAPABLE OF DELIVERING NOT MORE THAN 10,000 RMS SYMETRICAL AMPERES, 600 VOLTS MAXIMUM.
- SUITABLE FOR USE ON A CIRCUIT CAPABLE OF DELIVERING NOT MORE THAN 100,000 RMS SYMETRICAL AMPERES, 600 VOLTS MAXIMUM WHEN PROTECTED BY A CLASS J FUSE RATED 175A.

wa_sg03511



Description

- For MCB FAZ-NA/RT
- 16 mm²
- Pin busbar
- Accessories available:
 - Terminals
 - Busbar tag shrouds
- Several length

2.350 Busbar Systems

xEffect Busbar System UL489 16mm², (Pin) Z-SV/UL16

Description	Step Distance (mm)	Cu-factor	Type Designation	Article No.	Units per package
-------------	--------------------	-----------	------------------	-------------	-------------------

For FAZ-NA/RT, not sliceable!!

- Delivered with end caps

wa_sg03511



16 mm², Rated current 80 A

1-phase, 6MU	17.6	0.035	Z-SV/UL-16/1P-1TE/6	104892	10
1-phase, 12MU	17.6	0.07	Z-SV/UL-16/1P-1TE/12	104893	10
1-phase, 18MU	17.6	0.105	Z-SV/UL-16/1P-1TE/18	104894	10
2-phase, 6MU	17.6	0.07	Z-SV/UL-16/2P-2TE/6	104895	10
2-phase, 12MU	17.6	0.14	Z-SV/UL-16/2P-2TE/12	104896	10
2-phase, 18MU	17.6	0.21	Z-SV/UL-16/2P-2TE/18	104897	10
3-phase, 6MU	17.6	0.14	Z-SV/UL-16/3P-3TE/6	104898	10
3-phase, 12MU	17.6	0.221	Z-SV/UL-16/3P-3TE/12	104899	10
3-phase, 18MU	17.6	0.332	Z-SV/UL-16/3P-3TE/18	104900	10

Accessories

Terminals

SG07506



2,5 - 35mm ²	-	0.035	Z-EK/35/UL	104901	3
1,5 - 50mm ²	-	0.038	Z-EB/50/UL	104902	3

Busbar Tag Shrouds

SG07706



for 3 pins	-	-	ZV-BS-UL	104904	10
------------	---	---	----------	--------	----

Description of the Busbar UL489 Z-SV/UL-16 for FAZ-NA/RT

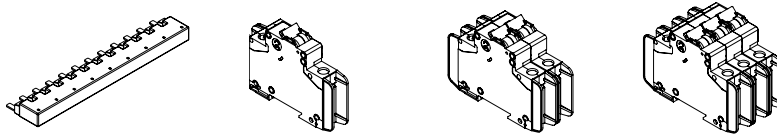

Article No.				
104892	Z-SV/UL-16/1P-1TE/6	6	-	-
104893	Z-SV/UL-16/1P-1TE/12	12	-	-
104894	Z-SV/UL-16/1P-1TE/18	18	-	-
104895	Z-SV/UL-16/2P-2TE/6	-	3	-
104896	Z-SV/UL-16/2P-2TE/12	-	6	-
104897	Z-SV/UL-16/2P-2TE/18	-	9	-
104898	Z-SV/UL-16/3P-3TE/6	-	-	2
104899	Z-SV/UL-16/3P-3TE/12	-	-	4
104900	Z-SV/UL-16/3P-3TE/18	-	-	6
104901	Z-EK/35/UL	-	-	-
104902	Z-EB/50/UL	-	-	-
104904	ZV-BS-UL	-	-	-

Technical Data

		Z-SV/UL16
General		
Heat deflection temperature		125°C - UL94 V0
Standards		
Busbar		UL489, DIN EN 60947-1, VDE 0660 Teil 100 = IEC 60947-1:2004, IEC 60947-2:2003
Terminal		IEC 60999:2000, UL489, UL486A, CSA C22.2
Climate stability		according to DIN EN 60068
Insulation coordination		Overvoltage category III / Pollution degree 2
Electrical		
Impulse voltage strenght		≥ 9.5 kV (1 kV / mmLS)
Min. air distance		> 9.5 mm/25.4 mm (intern/external)
Min. creeping distance		> 12.7 mm/50.8 mm (intern/external)
Max. operating voltage		
1-, 3-phase		690 V IEC 480Y/277V & 240 V AC
Terminals		1.000 V AC/DC
Max. busbar current	I _g /Phase	80 A
Protection class		IP20
Short circuit rating		15 kA mit NH3 355 A gL 500 V JM / 7.5 kA 3 cycles @ 600 V
Dielectric strenght		>30 kV/mm

Mounting example of busbar UL489 Z-SV/UL-16 for FAZ-NA/RT

- ! ATTENTION:** Maximum of 3 commoning links allowed. Any combination of same pole configuration.
- ATTENTION:** 3 liaisons communes autorisées au maximum. Toute combinaison de configurations de polarité identiques.
- ACHTUNG:** Maximal 3 Schienenblöcke. Beliebige Kombination gleichpoliger Konfigurationen.
- ATTENZIONE:** Sono consentiti al massimo 3 pettini di collegamento in qualsiasi combinazione della stessa configurazione di poli.
- ATEÖION:** Se permite un máximo de 3 enlaces comunes. Cualquier combinación del mismo tipo de configuración de polo

- ! ~~✂~~ ATTENTION:** Do not cut.
- ATTENTION:** Ne pas couper.
- ACHTUNG:** Nicht durchschneiden.
- ATTENZIONE:** Non tagliare.
- ATEÖION:** No corte.

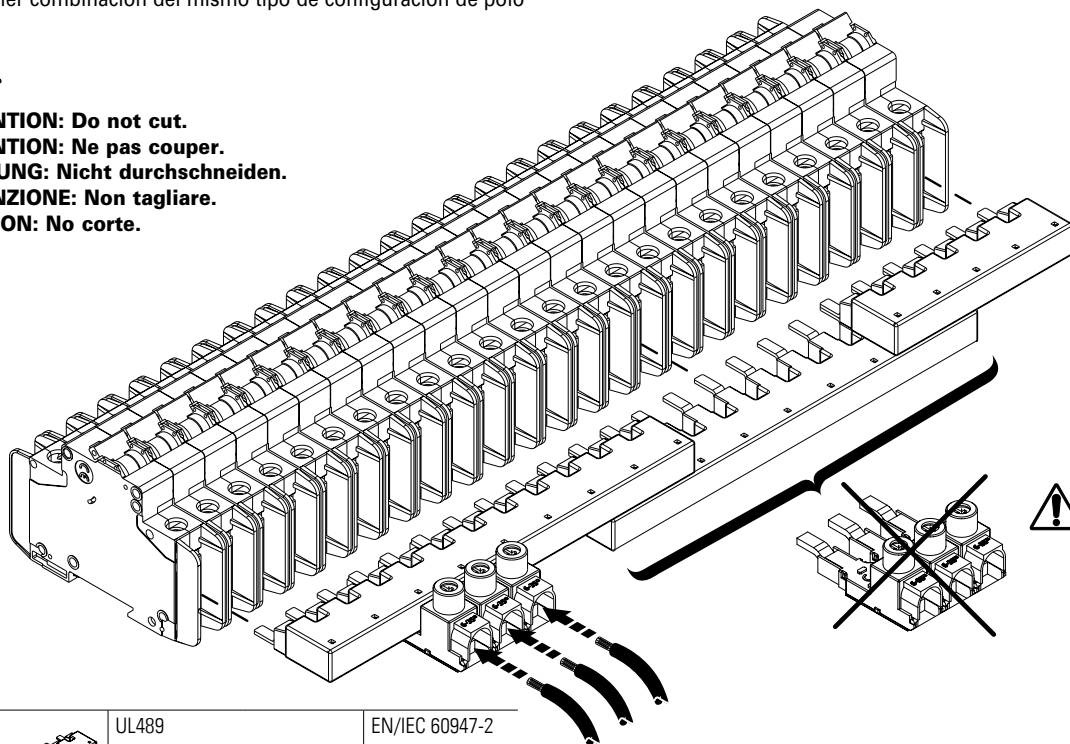

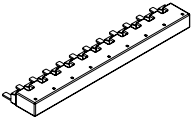
	UL489	EN/IEC 60947-2	
U_e	480 V AC	96 V DC	240/415 V AC
f	50/60 Hz	—	50/60 Hz
U_{imp}	—	—	9,5 kV
I_e	80 A @ 40°C	—	80 A @ 30°C
Terminal capacity	—	—	16 mm ²

Z-EB/50/UL

	UL489	EN/IEC 60947-2	
U_e	480 V AC	96 V DC	240/415 V AC
f	50/60 Hz	—	50/60 Hz
U_{imp}	—	—	9,5 kV

Cross section:

	U - single wire	K - fine wire (with sleeve)	Torque
	R - multi wire	F - fine wire (with sleeve)	
Max. cross section	50 mm ² 1 AWG copper wire	35 mm ² 2 AWG copper wire	4 Nm 35 lbf.in
Min. cross section	1,5 mm ² 14 AWG copper wire		
Busbar-side	Pin max. 5,5x2 / 0.2"x0.07" Länge min. 12,7 mm / Length min. 0.5"		2,5 Nm 22 lbf.in

Z-EK/35/UL

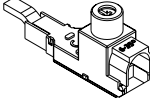
	UL489	EN/IEC 60947-2	
U_e	480 V AC	96 V DC	240/415 V AC
f	50/60 Hz	—	50/60 Hz
U_{imp}	—	—	9,5 kV

Cross section:

	U - single wire	K - fine wire (with sleeve)	Torque
	R - multi wire	F - fine wire (with sleeve)	
Max. cross section	35 mm ² 2 AWG copper wire		5,5 Nm 50 lbf.in
Min. cross section	2,5 mm ² 14 AWG copper wire		

Mounting example of busbar UL489 Z-SV/UL-16 for FAZ-NA/RT

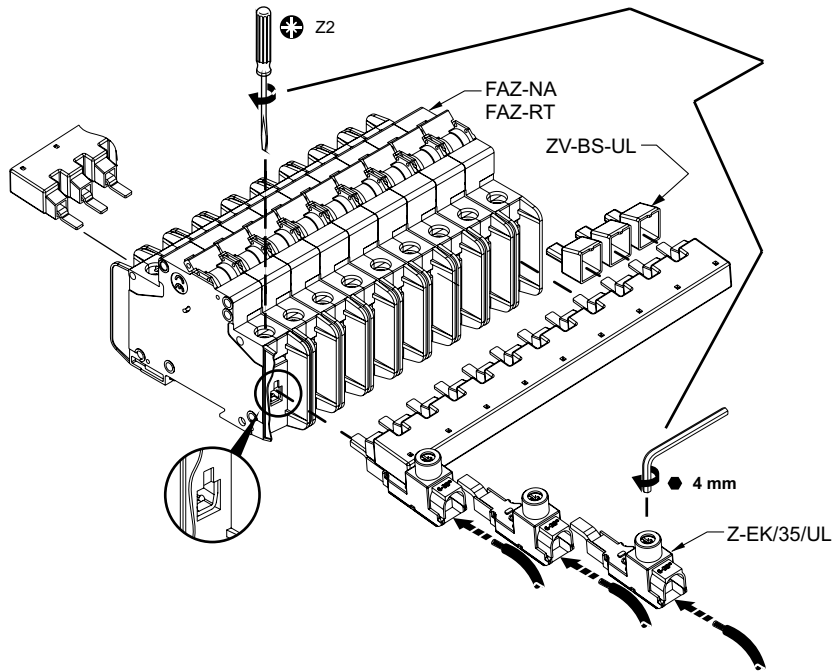

AWG	lb-in	Nm
14	21	2.3
12-8	25	2.8
6-2	36	4.0

IEC/EN 60947-2 I_{cc}

	U _e V AC	Z-SV/UL I _{cc} A
	240/415	15000

UL SCCR

	FAZ-NA FAZ-RT I _n A	U _e V AC	Z-SV/UL SCCR RMS Sym A
	0.5-32 35-40	480Y/277 240	10000 10000

2.354 Busbar Systems

AFDD Busbar EVG-2PHAS/4AFDD

xEffect

sg05517



Phases	Cu-factor	Type Designation	Article No.	Units per package
2-phase	0.114	EVG-2PHAS/4AFDD	193378	10



Technical Data



Products are EU conform and correspond to the RoHS of the EU

EVG-2PHAS/4AFDD	
General	
Busbar	Copper
Surface busbar	plain
Insulation	PC/ABS
Surface insulation	grey
Standards	EN 60947-1:2007 / IEC 60947-1:2007
Heat deflection temperature	90 °C – UL94 V0
Glow Wire Flammability Index	960 °C / 1 mm
Insulation coordination	Overvoltage category III / Pollution degree 2
Electrical	
Max. operating voltage	690 V AC/DC
Protection class	IP20
Rated impulse withstand voltage	$U_{imp} \geq 4,5 \text{ kV}$
Max. operating voltage	690 V IEC
1-, 3-phase	480Y/277V & 240 V AC
Load Capacity at 35°C ambient temperature depending of feeding point	
Max. busbar current feeding at beginning / ending	I_g/Phase 50 A
Busbar cross section	10 mm ²
Connection cross section	10 mm ²

Dimensions (mm)

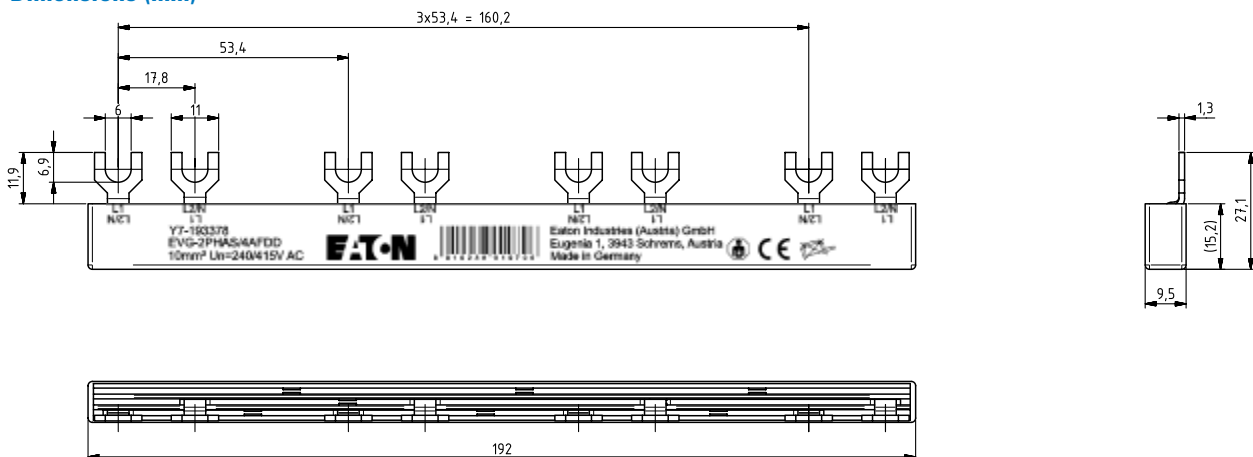

sg00121

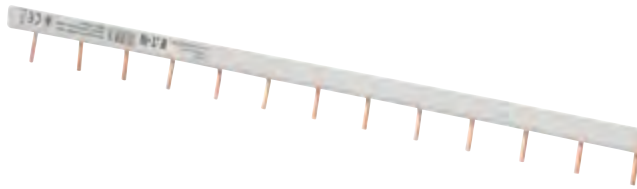

Description

- For Auxiliary and Signal Switches
- Sliceable
- 4 mm²
- Pin busbar
- Length ~ 1m
- Accessories available:
 - End cap

Description	Type Designation	Article No.	Units per package
Busbar for auxiliary contact			
4 mm²			
Short pin	Z-VPS-4/1p+HS	302375	20/200
Long pin	Z-VPL-4/1p+HS	302376	20/200
End cap	Z-VP-AK/1p	302377	10/500

sg00121



Description Busbar 4 mm²



Products are CE conform and correspond to the RoHS of the EU

Technical Data

Z-VPS / Z-VPL	
General	
Busbar	Copper
Surface busbar	plain
Insulation	PC/ABS
Surface insulation	grey
Standards	EN 60947-1:2007 / IEC 60947-1:2007
Heat deflection temperature	90 °C flame-retardant
Comparative Tracking Index	PLC 1
Insulation coordination	Overvoltage category III / Pollution degree 2
Electrical	
Max. operating voltage	1000 V AC / 1500V DC
Protection class	IP20

Load Capacity at 35 °C ambient temperature depending of feeding point

Max. busbar current feeding at beginning / ending	I _s /Phase 32 A
Busbar cross section	4 mm ²

Dimensions (mm)

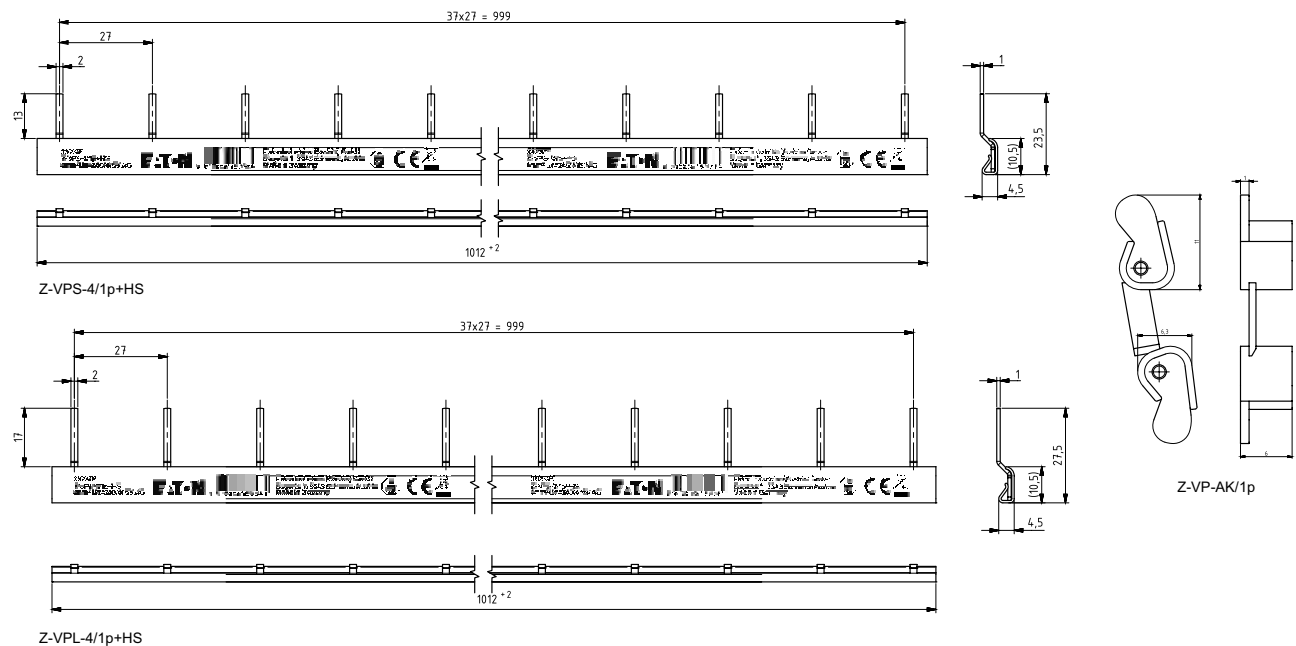

2.358 Busbar Systems

Busbar VPS, VPL for auxiliary contact

Connection examples

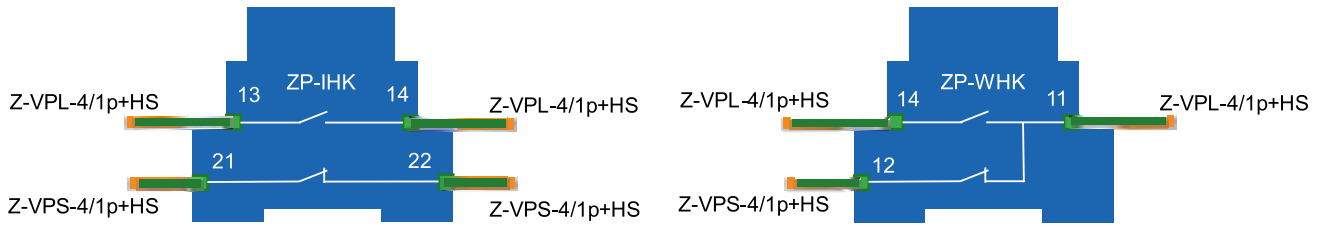

Approvals and shipping classifications for world markets

In their basic version, the Moeller-branded Eaton devices are approved for use throughout the world, including the USA and Canada. As such, they can be used without restriction as devices for world markets.

The standard versions of some devices, such as circuit breakers, can be used worldwide except in the USA and Canada.

For export to North America, numerous devices are available in special UL- and CSA-approved versions.

For currently available approvals, see our website:

<http://www.eaton.eu/approvals>

Eaton's Moeller-branded low-voltage switchgear and switchgear assemblies conform to national and international specifications, making it possible to construct control systems that will conform to the national and international specifications of any country in the world.

This, of course, means that due consideration must be given to the national standards of the respective country, such as those concerning installation, operation, installation materials and methods, as well as any pertaining to circumstances such as severe environmental conditions.

The device rating data given in this catalog for 220 – 240 V, 380 – 440 V, 500 V, 600 V, and 690 V covers virtually all existing three-phase systems worldwide.

Deviating requirements for the USA and Canada are given in detail in each chapter of this catalog. Read also the detailed description "Switchgear for North America" from Page 22/13. For the worldwide use of switchgear, special installation standards and approval requirements must also be observed in addition to the widely differing system conditions:

Where screw fuses are used in a control system, some European countries – such as Denmark, Finland, the Netherlands, Norway and Sweden – require gage screws. In this case, "FORM P" fuse bases must be used. Switzerland no longer requires the use of gage screws, but they are still often requested by customers.

The majority of countries permit the import of switchgear assemblies and devices on the manufacturer's undertaking that they have been constructed in accordance with the pertinent specifications. In some countries, such as the USA and Canada, however, there is a legal obligation to obtain official approval. In these countries, devices and enclosures – sometimes even complete control systems – are tested and approved by independent bodies.

In Scandinavia and in Switzerland, an official approval for low-voltage switchgear and controlgear had to be sought to some extent. For industrial switchgear, this legal obligation has now been abolished, provided the devices have been manufactured and tested in accordance with harmonized European standards (such as IEC/EN 60947). There is then no longer a requirement for them to carry their country's own approval mark. Eaton develops switchgear to international

standards, such as IEC/EN 60947 and applies the corresponding marks. Devices that conform to the European Low-Voltage Directive and are sold within the European Union must contain the CE mark.



Europe, Conformité Européen (CE)

The CE mark indicates that the device corresponds with all relevant requirements and standards. Mandatory marking allows unrestricted use of marked devices within the European economic area.

Devices sold within the European union must comply with the Electromagnetic Compatibility (EMC) Directive. Eaton has performed the required tests for all Moeller-branded products subject to this Directive and applied the CE mark, which demonstrates compliance with the EMC Directive.

Because devices bearing the CE mark comply with the harmonized standards, approval and the associated marking is no longer required in the following countries: Belgium, Denmark, Finland, France, the Netherlands, Norway, Sweden, and Switzerland.

An exception is installation material. In some areas, miniature circuit breakers and residual current device must still be labeled and therefore carry the corresponding approval mark.



Belgien, Comité Electrotechnique Belge/Belgisch Elektrotechnisch Comité (CEBEC)



Germany, Verband Deutscher Elektrotechniker (VDE)



France, Union Technique de l'Electricité (UTE)



Austria, Österreichischer Verband für Elektrotechnik (ÖVE)



Switzerland, Schweizerischer Elektrotechnischer Verein (SEV)

Devices for export to the USA and Canada have either additional UL and CSA approval or are available in a separate version with UL and CSA approval.



USA, Underwriters Laboratories (UL) - Listing



USA, Underwriters Laboratories (UL) - Recognition



Canada, Canadian Standards Association (CSA)

Approval for electrical products is also required in Argentina, China, Russia, South Africa, and the Ukraine. Marking is partly mandatory for these countries. As in other European countries, the IEC rating data is accepted here. Romania requires that components that are to be used in public buildings must be approved by the Romanian test authority ICECON.

Russia

Devices for Russia must bear the appropriate marking.



Russia, Goststandart (GOST-R)

Ukraine

Devices for the Ukraine must bear the appropriate marking.



Ukraine, Goststandart (Ukrain-GOST)

China

Devices for China must bear the appropriate marking.



China, China Suitable Certification (CCC)

South Africa

In South Africa approval is mandatory for circuit breakers and busbar trunking systems: These devices must bear the appropriate marking.



South Africa, South African Bureau of Standards (SABS)

Argentina

In Argentina, mandatory approval is based on Resolution 92/98. From April 01, 2001, miniature circuit breakers and residual-current circuit breakers are subject to mandatory approval. As of this date, circuit breakers up to $I_n = 63$ A and $U_e \text{ max} = 440$ V must carry the following marks:



Argentinien, Instituto Argentino de Normalización y Certificación (IRAM)

Selection of devices

In addition to the required approvals and conformance with applicable regulations, the design of devices and systems themselves must be suitable for the target market. Points to keep in mind when selecting switchgear for export include:

Motor-protective circuit breakers

Use auto-protected circuit breakers, which are capable of controlling the highest prospective fault levels at the point of installation without the need for back-up protection.

Advantages

Can be positioned anywhere and are fully independent of the local circuit-protection system; no spare part problems

Circuit-breakers

Use makes with visible contacts, and quick-make and quick-break operation as standard. For high short-circuit levels, use current-limiting circuit breakers. Selective switches are recommended for the selective graduation of networks.

Advantages

Independence from local accident prevention regulations requiring visible contacts, and safety from faults caused by inexperienced operating personnel. The effects of shortcircuits are kept to a minimum. Fuseless installations offer greater safety and reliability in plant operation. In the event of a fault, only the faulty section of the system is isolated.

Contactors

Use contactors whose entire range provides consistently reliable operation in the event of voltage drops (80% U_n should be aimed for) and whose contact system will not assume an indeterminate position on closing or opening under these conditions.

Advantages

During the electrification work in areas such as Africa and the Middle East, an insufficient voltage stability is – at least for a certain time – likely in many applications (for example due to long spur lines or small local generators).

The use of devices that fulfil the above requirements will eliminate one of the main failure causes related to contactors.

Enclosures

Use insulated enclosures with transparent covers (i.e. "totally insulated" enclosures).

Approvals and shipping classifications for world markets

Advantages

Total insulation is the best possible protective measure from the user's point of view, avoiding, reliance on the possibly doubtful skills of unknown installation personnel. Furthermore, protective measures based on grounding are often extremely difficult, if not impossible (in the Middle East, for example, due to the dryness of the ground). Insulated enclosures completely eliminate the need for any additional protection against corrosion. The transparent covers contribute significantly to the correct operation of a system, because switchgear operation can be monitored even with the doors or covers closed, thus virtually eliminating the possibility of these being left open through carelessness. The transparent cover is an important contribution to safety, especially where exports to areas of uncertain skills are concerned.

Overcurrent protection devices

Always use circuit breakers or motor-protective circuit breakers and avoid fuses wherever possible.

Advantages

The operational reliability of a system is especially important for export contracts. Circuit-breakers and motor-protective circuit breakers provide this reliability in full measure since they can be immediately reclosed once a fault has been cleared, they disconnect all poles, they have ideal protection through high tripping accuracy and they can be used for selective operation. Because they have no fuses or other consumables, they also greatly reduce the problem of obtaining replacement parts. The advantages of fuseless design for export are especially evident in this case. No complicated investigation is needed to find out which fusing system is used in the respective location and which specifications have to be followed to select the correct fuses. Often several different fuse systems with widely varying characteristics are used side-by-side in the same country. For the uninitiated, it may be almost impossible to find the right fuse in these circumstances. These problems do not arise where a circuit-breaker is used.

Main switch and safety switch

Use devices with positive contact separation and clear switch position indication.

Advantages

The mechanical coupling of the actuating element with the contacts ensures that the Off position is indicated only when all main contacts are separated by the prescribed distance, and only in this position can the switch be padlocked. This ensures safety when carrying out maintenance and repair work on the installation or machinery.

Shipping classifications

Many Moeller-branded Eaton devices are approved by all important shipping associations: Germanischer Lloyd, Lloyd's Register of Shipping, Bureau Veritas, Russian Maritime Register of Shipping, Registro Italiano Navale, Det Norske Veritas, Polski Rejestr Statków, etc. Because the status of currently valid shipping approvals is subject to significant variations, this Catalog does not provide an overview, as this would quickly be out of date.

Please see our corresponding, up-to-date information on the Internet. <http://www.eaton.eu/approvals>

Switchgear for the global market and for North America:

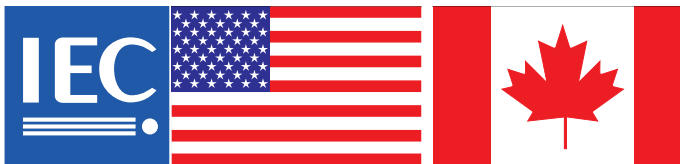

Practically all devices can be used in compliance with IEC norms.

The selection pages of this catalogue indicate the products that have been approved for the North American market with the USA and Canadian flags. This does not mean these devices are exclusively for North America! Approval for North America has been granted special emphasis due to the strong export share of these devices and because standards deviate from IEC/EN norms, selection and processing requirements must be highlighted. The article "Switchgear for North America" in the appendix of this catalogue contains everything you need to know about this subject. A glossary in the appendix explains the specifically American technical terms.

Information relevant for export to North America

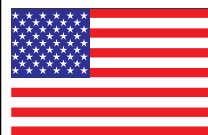

Product Standards	IEC/EN 60947-5; UL 508, CSA-C22.2 No. 14; CE marking
UL File No.	E29184
UL CCN	NKCR
CSA File No.	12528
CSA Class No.	3211-03
NA Certification	UL Listed, CSA Certified
Degree of Protection	IEC: IP65, UL/CSA Type 3R, 4X (indoor use only), 12, 13

Example for such an instruction.

The Std. pack column on the order pages also uses flags to indicate the articles for which the UL/CSA notes apply. Selecting a technically appropriate device also opens information to help you document suitability for use in North America on your own with a minimum of research (see above).

Eaton Online Catalog – find product details quickly and efficiently!

You can find comprehensive up-to-date product information at <http://ecat.eaton.com>

Lookup

You can search by keywords, product names, article numbers, technical data: The search understands everything and takes you straight to the product you're looking for.

Graphical navigation

Graphical representation of the fields of application and product groups.

Selection aids

Tailored to the typical expert's approach, this search aid helps you quickly find the product you need.

Data sheets

For every article the catalog can generate a technical data sheet, which you can convert to a PDF file for printing or saving with a single click.

Parts lists

From your search results you can create a parts list that you can then send to your Eaton sales partner as a query.



HTML data sheet; can be saved as PDF file.

Parts list

Item	Qty	Photo	Article no.	PART No.	Short Text
1	1		118117	ES4P-221-DARD1	64Ntr control eqp, 24V DC bias.
2	1		220150	FAK-C08EY100V1	Complete I/OB
3	1		204011	ME22-JULM-20-A1110	Double act. Jrm. 500V off autor cut
4	1		250000	SLM15-21-15M15KZ-COV1MKT	Contact 7 250V/50V AC-operated
5	1		118116	PKS140110	PKS14 + 100-100V 1500W/0.5-6EA

Submit as:

Desktop position Save changes Add new questions

Parts list, e.g. for queries to Eaton Sales.

You can find comprehensive up-to-date information about Eaton's automation products and switchgear in our Online Catalog.



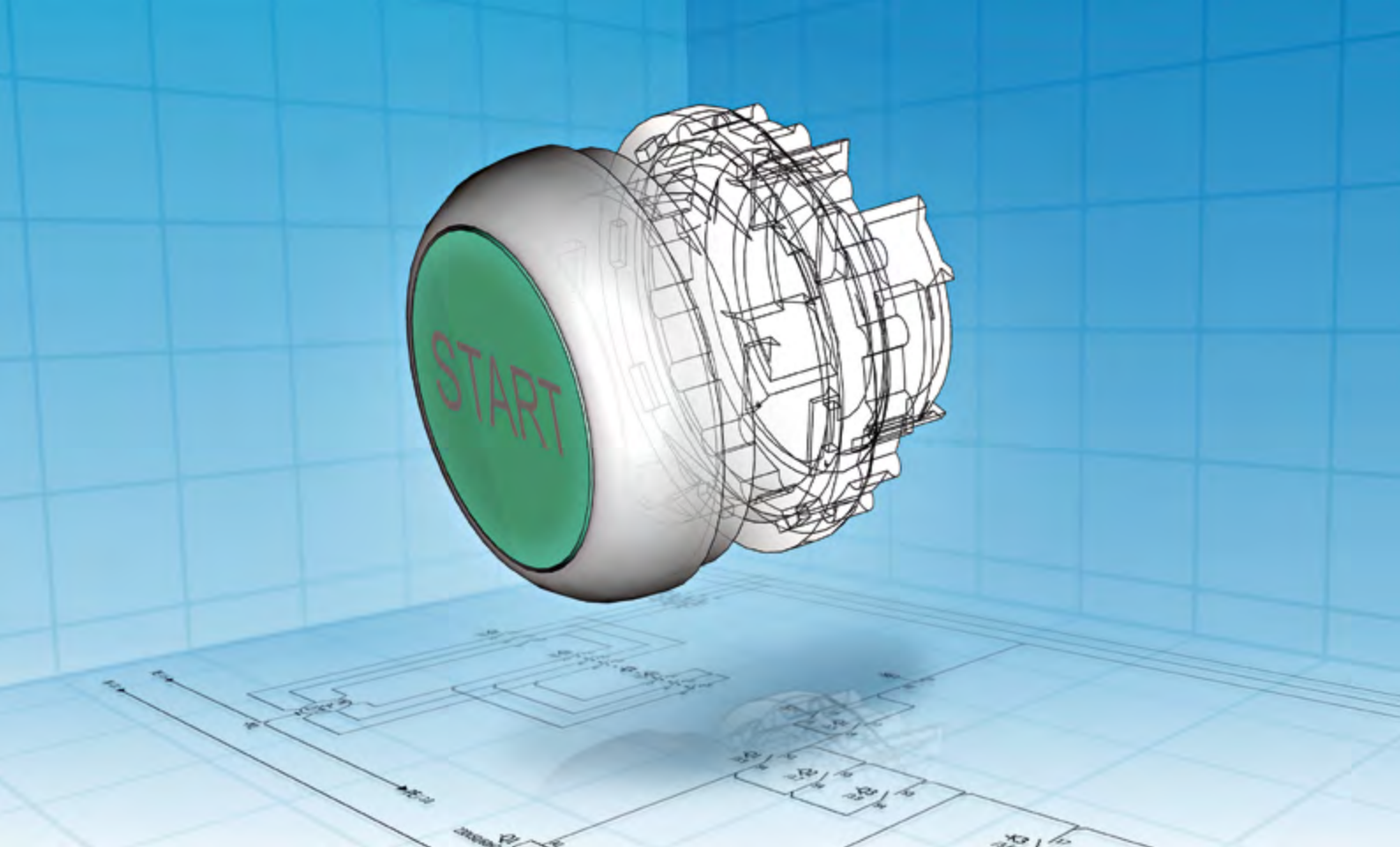

Planning safety and process optimization: CAD data at the click of a mouse!



- 22,000 article data items and macros
- Download from EPLAN Data Portal
- Version P8



- Models for approx. 22,000 products
- 80 different neutral & native formats



www.eaton.eu/cad

Eaton is providing its customers with CAD data to offer optimum support during planning. Both electrical and mechanical design data can be called up quickly and conveniently from the Internet at any time. This reduces processing times, minimizes errors and thus reduces costs already in the engineering phase of control panels, systems and machinery.

eCAD: Eaton has product data and macros available for EPLAN Electric P8. More than 22,000 products, but will also be able to export them and import them into your own EPLAN item database.

mCAD: Eaton makes 2D and 3D data available for more than 20,000 products. Over 80 different neutral and native formats guarantee compatibility with the project engineering systems of the customer. The models can either be integrated directly into the planning software from the Partcommunity Portal on the Internet or via the CADENAS Partsolution software.

Eaton's electrical business is a global leader with deep regional application expertise in power distribution and circuit protection; power quality, backup power and energy storage; control and automation; life safety and security; structural solutions; and harsh and hazardous environment solutions. Through end-to-end services, channel and an integrated digital platform & insights Eaton is powering what matters across industries and around the world, helping customers solve their most critical electrical power management challenges.

For more information, visit [Eaton.com](https://www.eaton.com).



<http://id1.hu/eaton>

Eaton Industries (Austria) GmbH
Scheydgasse 42
1210 Vienna
Austria

Eaton
EMEA Headquarters
Route de la Longeraie 7
1110 Morges, Switzerland

© 2018 Eaton
All Rights Reserved
Publication No. CA003002EN
Article number 173023-MK
February 2023

Changes to the products, to the information contained in this document, and to prices are reserved; as are errors and omissions. Only order confirmations and technical documentation by Eaton is binding. Photos and pictures also do not warrant a specific layout or functionality. Their use in whatever form is subject to prior approval by Eaton. The same applies to trademarks (especially Eaton, Moeller, and Cutler-Hammer). The Terms and Conditions of Eaton apply, as referenced on Eaton Internet pages and Eaton order confirmations.

Eaton is a registered trademark.

All other trademarks are property of their respective owners.

Follow us on social media to get the latest product and support information.

