

# Controlling & Switching Busbar Systems Other Accessories



Catalog



Powering Business Worldwide

SG10611



SG83911







SG82911



## Description

- Switches
- Installation Contactors
- Relays
- Signalling Devices
- Transformers

### Main Load Disconnecter Switch (Isolator) IS

	Rated current (A)	Poles	Type Designation	Article No.	Units per package
	16	1	IS-16/1	276254	12/120
	16	2	IS-16/2	276255	1/60
	16	3	IS-16/3	276256	1/40
	16	4	IS-16/4	276257	1/30
	20	1	IS-20/1	276258	12/120
	20	2	IS-20/2	276259	1/60
	20	3	IS-20/3	276260	1/40
	20	4	IS-20/4	276261	1/30
	25	1	IS-25/1	276262	12/120
	25	2	IS-25/2	276263	1/60
	25	3	IS-25/3	276264	1/40
	25	4	IS-25/4	276265	1/30
	32	1	IS-32/1	276266	12/120
	32	2	IS-32/2	276267	1/60
	32	3	IS-32/3	276268	1/40
	32	4	IS-32/4	276269	1/30
	40	1	IS-40/1	276270	12/120
	40	2	IS-40/2	276271	1/60
	40	3	IS-40/3	276272	1/40
	40	4	IS-40/4	276273	1/30
	63	1	IS-63/1	276274	12/120
	63	2	IS-63/2	276275	1/60
	63	3	IS-63/3	276276	1/40
	63	4	IS-63/4	276277	1/30
	80	1	IS-80/1	276278	12/120
	80	2	IS-80/2	276279	1/60
	80	3	IS-80/3	276280	1/40
	80	4	IS-80/4	276281	1/30
	100	1	IS-100/1	276282	12/120
	100	2	IS-100/2	276283	1/60
	100	3	IS-100/3	276284	1/40
	100	4	IS-100/4	276285	1/30
	125	1	IS-125/1	276286	12/120
	125	2	IS-125/2	276287	1/60
	125	3	IS-125/3	276288	1/40
	125	4	IS-125/4	276289	1/30

Description	Type Designation	Article No.	Units per package
-------------	------------------	-------------	-------------------

### Accessories

	Terminal cover	Z-IS/AK-1MU	276290	10/600
---	----------------	-------------	--------	--------

### Switching interlock IS/SPE-1MU

- Without lock
- Also suitable for PFIM, PKNM

### Terminal cover Z-IS/AK-1MU

- Can be sealed with leads
- Modular design, width 1 MU

**Description Main Load Disconnecter Switch (Isolator) IS**

- Load circuit breaker with isolating function
- Design according to IEC/EN 60947-3
- Highly wear resistant contacts
- Quick make, black toggle
- Terminal capacity 50 mm<sup>2</sup>
- Compatible busbars with switchgear series Xpole by use of the mouth terminal in combination with standard fork busbar

**Technical Data**

	IS-16	IS-20	IS-25	IS-32	IS-40	IS-63	IS-80	IS-100	IS-125
<b>Electrical</b>									
Design	according to IEC/EN 60947-3								
Rated voltage	240/415 V								
Frequency	50/60 Hz								
Rated insulation voltage	$U_i$	690 V~							
Rated peak withstand voltage	$U_{imp}$	6 kV							
Pollution degree	3								
Rated short-time withstand current	$I_{cw}$	2 kA							
Rated short-circuit making capacity	$I_{cm}$	2.8 kA							
Rated current 240/415 V, AC23A	16 A	20 A	25 A	32 A	40 A	63 A	80 A	100 A	125 A
Number of poles	1-, 2-, 3-, 4-pole								
Maximum back-up fuse	125 A gG								
Short-circuit current strength - with back-up fuse according to IEC/EN 60947-3	12.5 kA	12.5 kA	12.5 kA	12.5 kA	12.5 kA	12.5 kA	12.5 kA	10 kA	10 kA
Endurance									
operating cycles electrical components	≥ 3,000	≥ 3,000	≥ 3,000	≥ 3,000	≥ 3,000	≥ 3,000	≥ 3,000	≥ 3,000	≥ 2,000
operating cycles mechanical components	≥ 16,000	≥ 16,000	≥ 16,000	≥ 16,000	≥ 16,000	≥ 16,000	≥ 16,000	≥ 16,000	≥ 14,000
<b>Mechanical</b>									
Frame size	45 mm								
Device height	80 mm								
Device width	17.5mm/pole								
Mounting	quick fastening with 2 lock-in positions on DIN rail IEC/EN 60715								
Degree of protection, built-in	IP40								
Terminal protection	finger and hand touch safe according to DGUV VS3, EN 50274								
Upper and lower terminals	Twin-purpose terminals								
Terminal capacity	2.5 - 50 mm <sup>2</sup>								
Busbar thickness	0.8 - 2 mm								
Tightening torque of terminal screws	2.5 - 5 Nm								
Function	irrespective of the position of installation								

**Connection diagram**

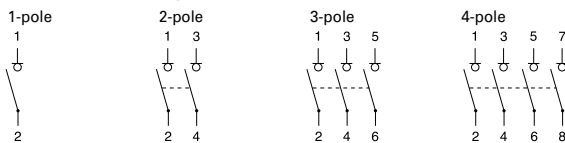

**Dimensions (mm)**

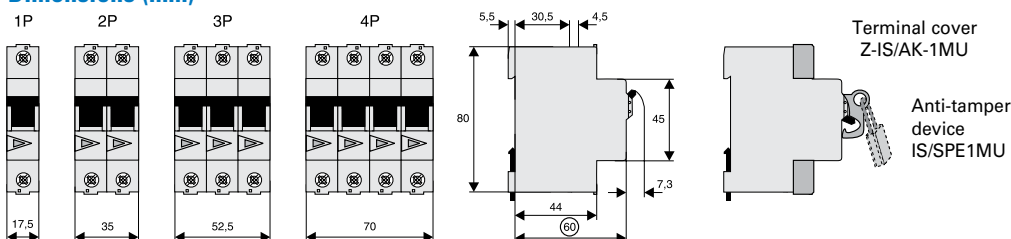



SG00912



Poles	Rated current (A)	Type Designation	Article No.	Units per package
<b>Circuit Breaker ZP-A</b>				
1	40	ZP-A40/1	248263	12 / 120
2	40	ZP-A40/2	248264	1 / 60
3	40	ZP-A40/3	248265	1 / 40
3+N	40	ZP-A40/3N	248266	1 / 30
1	63	ZP-A63/1	284906	12 / 120
2	63	ZP-A63/2	284907	1 / 60
3	63	ZP-A63/3	284908	1 / 40
3+N	63	ZP-A63/3N	284909	1 / 30

### Description Circuit Breaker ZP-A

- Design according to IEC/EN 60947-1, -3
- Poles: 1, 2, 3, 3N
- Rated current: 40 A, 63 A
- Accessories for switchgear also for ZP-A usable!

#### Accessories:

Auxiliary switch for subsequent installation	ZP-IHK	286052
	ZP-WHK	286053
Tripping signal contact for subsequent installation	ZP-NHK	248437
Shunt trip release	ZP-ASA/..	248438, 248439
Undervoltage release	Z-USA/..	248288-248291
Additional terminal 35 mm <sup>2</sup>	BB-UL-TEPA/35	169823
Anti-tamper device	Z-IS/SPE-1MU	274418

### Technical Data

ZP-A		
<b>Electrical</b>		
Rated operational voltage	$U_e$	230/400 V AC
Rated frequency		50 Hz
Rated insulation voltage	$U_i$	440 V AC
Rated peak withstand voltage (1.2/50 $\mu$ S)	$U_{imp}$	4 kV
Conventional thermal current	$I_{th}$	
ZP-A40		40 A
ZP-A63		63 A
Utilisation category AC22A		
Minimum voltage per contact	$I_e$	
ZP-A40		40 A AC
ZP-A63		63 A AC
Utilisation category AC23A		
Minimum voltage per contact	$I_e$	16 A AC
Short-circuit current strength with back-up fuse 40 A gG		3 kA ( $U = 240$ V, $\cos\phi = 0.87$ )
Endurance		
electrical components		$\geq 8,000$ switching operations
mechanical components		$\geq 20,000$ switching operations
<b>Mechanical</b>		
Frame size		45 mm
Device height		80 mm
Device width		17.5mm/pole
Mounting		quick fastening on DIN rail IEC/EN 60715
Degree of protection, built-in		IP40
Terminal protection		finger and hand touch safe according to DGUV VS3, EN 50274
Upper and lower terminals		lift terminals + guide for secure terminal
Terminal capacity		1.5-25 mm <sup>2</sup>
Terminal screws		M5 (Pozidrive) Z2
Tightening torque of terminal screws		max. 2.4 Nm

Connection diagram

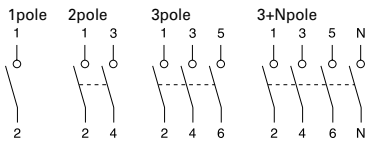

Dimensions (mm)

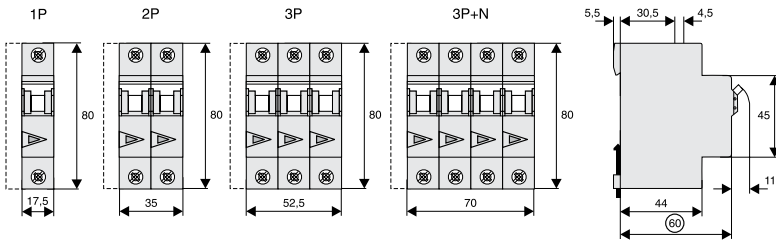

Practical Hint

e.g. 16(2)A ....

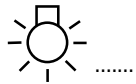

Ratings for resistive/inductive consumers

Ratings for incandescent lamp load (AC 5b IEC 60947-4)

ÖVE-SN45, § 305

Practical Hint

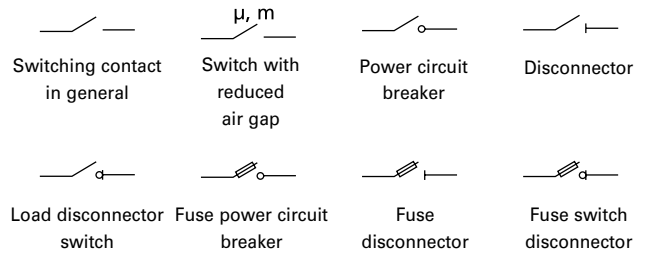

ÖVE-SN45, § 207, IEC 60947-3

# 1.6

## Controlling & Switching

xPole

Pushbutton Z-T/; Control Switch Z-S/..; Changeover Switch Z-S/W

Colour	Pushbutton/Function	Type Designation	Article No.	Units per package
--------	---------------------	------------------	-------------	-------------------

### Pushbutton Z-T/

SG37112



green	4NO	Z-T/4S-G	248328	12 / 120
black	3NO+1NC	Z-T/3S10	248330	12 / 120

Function	Type Designation	Article No.	Units per package
----------	------------------	-------------	-------------------

### Control Switch Z-S/..

SG38912



3NO	Z-S/3S	248334	12 / 120
4NO	Z-S/4S	248335	12 / 120
2NO+2NC	Z-S/SS00	248337	12 / 120
3NO+1NC	Z-S/3S10	248338	12 / 120

Function	Type Designation	Article No.	Units per package
----------	------------------	-------------	-------------------

### Changeover Switch Z-S/W

SG39012



1CO I-0-II	Z-S/WM	248345	12 / 120
2CO I-0-II	Z-S/2WM	248346	12 / 120
1CO DAY-0-NIGHT	Z-S/WTN	248347	12 / 120
2CO DAY-0-NIGHT	Z-S/2WTN	248348	12 / 120

**Description Pushbutton Z-T/; Control Switch Z-S/..; Changeover Switch Z-S/W**

- Design according to IEC 60669, IEC 60669-1
- Types Z-S/WM and /2WM with central position (0-position)
- Types Z-S/WTN and -2WTN with TAG-0-NACHT (DAY-0-NIGHT) printed onto the device

**Technical Data**

	Z-T/	Z-S/..	Z-S/W
<b>Electrical</b>			
Rated voltage	230 V AC	240 V AC	240 V AC
Frequency	50 HZ	50 HZ	50 HZ
Rated current	16 A / 230 V~	20 A / 240 V~	20 A / 240 V~
Switching capacity	–	1.25 x I <sub>n</sub> ; 1.1 x U <sub>n</sub>	1.25 x I <sub>n</sub> ; 1.1 x U <sub>n</sub>
Short-circuit current strength	10 kA	10 kA	10 kA
<b>Mechanical</b>			
Switching toggle	–	black	black
Pushbutton colour	green - NO black - NO/NC	–	–
Frame size	45 mm	45 mm	45 mm
Device height	80 mm	80 mm	80 mm
Device width	17.5 mm (1MU)	17.5 mm (1MU)	17.5 mm (1MU)
Mounting	quick fastening with 2 lock-in positions on DIN rail IEC/EN 60715		
Degree of protection, built-in	IP40	IP40	IP40
Upper and lower terminals	lift terminals	lift terminals	lift terminals
Terminal capacity (rigid wires only)	1-10 mm <sup>2</sup>	1-10 mm <sup>2</sup>	1-10 mm <sup>2</sup>
Terminal protection	finger and hand touch safe according to DGUV VS3, EN 50274		
Resistance to climatic conditions	acc. to IEC/EN 60068	acc. to IEC/EN 60068	acc. to IEC/EN 60068
Load of self-ballasted lamp (SBL)		200 W cap. load	200 W cap. load
Operation temperature		-25° C .... +40° C	-25° C .... +40° C

**Connection diagram**

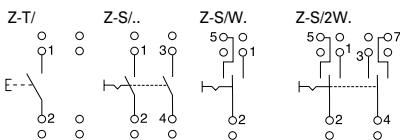

**Dimensions (mm)**

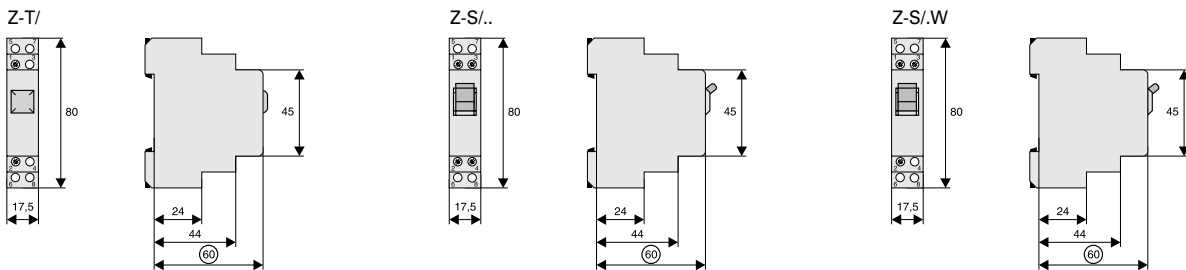



Switch Z-SW.; Signal Lamps Z-EL, Z-DL., Z-BEL; Pushbutton Z-PU.

Rated voltage LED	Function	Type Designation	Article No.	Units per package
-------------------	----------	------------------	-------------	-------------------

**Switch Z-SW, Z-SWL**

- Z-SWL: with LED
- 16 A 250 VAC

SG59911



–	1NO	Z-SW/S	276300	2 / 120
–	2NO	Z-SW/SS	276301	2 / 120
–	1NO+1NC	Z-SW/SO	276302	2 / 120
–	1CO	Z-SW/W	276303	2 / 120
24 V AC/DC	2NO	Z-SWL24/SS	276304	2 / 120
24 V AC/DC	1NO+1NC	Z-SWL24/SO	276305	2 / 120
230 V AC/DC	1NO	Z-SWL230/S	292300	2 / 120
230 V AC/DC	2NO	Z-SWL230/SS	276306	2 / 120
230 V AC/DC	1NO+1NC	Z-SWL230/SO	276307	2 / 120

Additional LED colours, voltages and contact functions upon enquiry.

Description	Type Designation	Article No.	Units per package
-------------	------------------	-------------	-------------------

**Busbar**

wa\_sg02512



Z-EK/25

1pole angulated grey 10 mm <sup>2</sup>	Z-SV-10/1P-F/13	264918	10
1pole angulated blue 10 mm <sup>2</sup>	Z-SV-10/N-F/13	264919	10
1pole angulated grey 16 mm <sup>2</sup>	Z-SV-16/1P-1MU/F	269523	25
1pole angulated blue 16 mm <sup>2</sup>	Z-SV-16/N-1MU/F	269524	25
Extension terminal 25 mm <sup>2</sup> long, straight	Z-EK/25	264935	10 / 600
Extension terminal 25 mm <sup>2</sup> short, straight	Z-EK/25/K	269525	10 / 600
Extension terminal 25 mm <sup>2</sup> long, crosswise	Z-EK/25/QL	264937	10 / 600
Extension terminal 25 mm <sup>2</sup> short, crosswise	Z-EK/25/Q	264936	10 / 600

Rated voltage LED	Colour	Type Designation	Article No.	Units per package
-------------------	--------	------------------	-------------	-------------------

**Signal Lamps**

SG59211



Z-BEL/R230

**Single Lamp Z-EL**

24 V AC/DC	orange	Z-EL/OR24	275444	2 / 120
24 V AC/DC	white	Z-EL/WH24	107493	2 / 120
230 V AC/DC	red	Z-EL/R230	284921	2 / 120
230 V AC/DC	green	Z-EL/G230	284922	2 / 120
230 V AC/DC	orange	Z-EL/OR230	275865	2 / 120
230 V AC/DC	blue	Z-EL/BL230	103131	2 / 120
230 V AC/DC	white	Z-EL/WH230	107494	2 / 120

**Twin Lamp Z-DLD**

2 x 24 V AC/DC	red + green	Z-DLD/2/24	284926	2 / 120
2 x 230 V AC/DC	red + green	Z-DLD/2/230	284925	2 / 120
2 x 24 V AC/DC	white + white	Z-DLD/WH24	108897	2 / 120
2 x 230 V AC/DC	white + white	Z-DLD/WH230	108898	2 / 120

**Universal Single Lamp - changeover function Z-UEL**

24 V AC/DC	red/green	Z-UEL24	284924	2 / 120
230 V AC/DC	red/green	Z-UEL230	284923	2 / 120

**Universal Twin Lamp - changeover function Z-UDL**

2 x 24 V AC/DC	red/green	Z-UDL24	284928	2 / 120
2 x 230 V AC/DC	red/green	Z-UDL230	284927	2 / 120

**Signal Lamp - with integrated flash function Z-BEL**

24 V AC/DC	red	Z-BEL/R24	284931	2 / 120
24 V AC/DC	green	Z-BEL/G24	284932	2 / 120
230 V AC/DC	red	Z-BEL/R230	284929	2 / 120
230 V AC/DC	green	Z-BEL/G230	284930	2 / 120

Switch Z-SW.: Signal Lamps Z-.EL, Z-.DL., Z-BEL; Pushbutton Z-PU.

Rated voltage LED	Function	Type Designation	Article No.	Units per package
-------------------	----------	------------------	-------------	-------------------

**Pushbutton Z-PU, Z-PUL**

- Z-PUL: with LED
- 16 A 250 VAC

SG59811



–	1NO	Z-PU/S	276291	2 / 120
–	2NO	Z-PU/SS	276292	2 / 120
–	1NO+1NC	Z-PU/SO	276293	2 / 120
–	2NC	Z-PU/OO	276294	2 / 120
24 V AC/DC	2NO	Z-PUL24/SS	276295	2 / 120
24 V AC/DC	1NO+1NC	Z-PUL24/SO	276296	2 / 120
230 V AC/DC	2NO	Z-PUL230/SS	276297	2 / 120
230 V AC/DC	1NO+1NC	Z-PUL230/SO	276298	2 / 120
230 V AC/DC	2NC	Z-PUL230/OO	276299	2 / 120

**Description Pushbutton Z-T/; Control Switch Z-S/..; Changeover Switch Z-S/W**

- Design according to IEC/EN 60669, VDE 0632
- Low power loss
- Long service life
- Twin lamp with separate connections
- Colour red/green, can be selected by alternative wiring
- Flash option by usage of different terminals only, changeover option, no additional relay necessary (Z-BEL)
- Terminals with guide for secure terminal connection
- Identical terminal screws for coil and contacts

**Technical Data**

	Z-.EL, Z-.DL., Z-BEL	Z-PU, Z-PUL	Z-SW, Z-SWL
<b>Electrical</b>			
Rated voltage	–	250 V AC	250 V AC
Frequency	–	50 HZ	50 HZ
Rated current	–	16 A	16 A
<b>LED</b>			
Rated voltage	230 V AC/DC 24 V AC/DC	230 V AC/DC 24 V AC/DC	230 V AC/DC 24 V AC/DC
Range of operational voltage	(50 V) 110-240 V AC/DC (5 V) 12-24 V AC/DC	(50 V) 110-240 V AC/DC (5 V) 12-24 V AC/DC	(50 V) 110-240 V AC/DC (5 V) 12-24 V AC/DC
Luminosity	15 mcd	15 mcd	15 mcd
Power loss	2 W / LED	2 W	2 W
Switching capacity (200 operations)	–	1.25 x I <sub>n</sub> , 1.1 x U <sub>n</sub>	1.25 x I <sub>n</sub> , 1.1 x U <sub>n</sub>
Contact function	–	1S, 2S, 1NO+1NC, 2Ö	1S, 2S, 1NO+1NC
Flashing frequency	typ. 2 Hz (Z-BEL)	–	–
Maximum back-up fuse, short circuit	–	20 A gG	20 A gG
Self-ballasted load	–	200 W cap. load	200 W cap. load
<b>Mechanical</b>			
LED-Colour	red, green, red + green, white + white, red/green, orange, blue, white	orange	orange
Taster-Colour	–	green - NO red - NC black - NO/NC	black
Frame size	45 mm	45 mm	45 mm
Device height	90 mm	90 mm	90 mm
Device width	17.5 mm (1MU)	17.5 mm (1MU)	17.5 mm (1MU)
Mounting	quick fastening with 2 lock-in positions on DIN rail IEC/EN 60715		
Degree of protection, built-ines Gerät	IP40	IP40	IP40
Upper and lower terminals	lift terminals with guides for secure connection		
Terminal capacity			
one- or more wire	1 x (0.5 ...10) mm <sup>2</sup>	1 x (0.5 ...10) mm <sup>2</sup>	1 x (0.5 ...10) mm <sup>2</sup>
fine wires with wire end sleeve	1 x (0.5 ...10) mm <sup>2</sup>	1 x (0.5 ...10) mm <sup>2</sup>	1 x (0.5 ...10) mm <sup>2</sup>
Terminal protection	finger and hand touch safe according to DGUV VS3, EN 50274		
Resistance to climatic conditions	acc. to IEC/EN 60068	acc. to IEC/EN 60068	acc. to IEC/EN 60068

Switch Z-SW.; Signal Lamps Z-EL, Z-DL., Z-BEL; Pushbutton Z-PU.

### Connection diagram

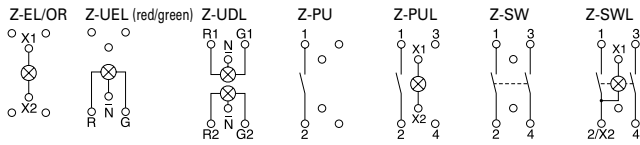

### Dimensions (mm)

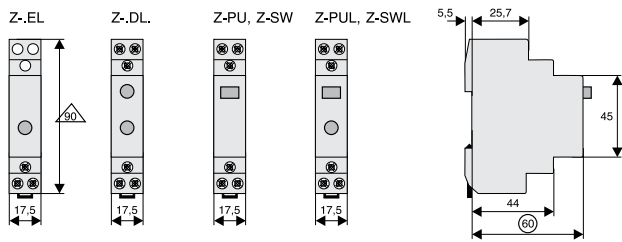

### Connection example for LED red/green

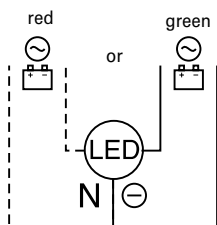

L(+) ≡ L(+) → same potential  
N(-) = neutral conductor

Changing of colour by connecting either R- or G-conductor terminal.

### Connection example for Blinkfunktion

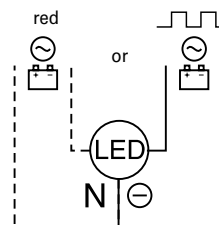

L(+) ≡ L(+) → same potential  
N(-) = neutral conductor

Changing of function by connecting either X2- or X3-conductor terminal.

SG85211



Z-DSU1-102

SG85311



Z-DSA2-01-SL

Function	Position	Type Designation	Article No.	Units per package
<b>Rotary Switch Z-DS</b>				
1pole OFF	0 - 1	Z-DSA1-01	248868	1 / 40
1pole CO	1 - 0 - 2	Z-DSU1-102	248869	1 / 40
1pole CO	HA - 0 - AU	Z-DSU1-H0A	248870	1 / 40
1pole CO	TA - 0 - NA	Z-DSU1-T0N	248871	1 / 40
2pole OFF	0 - 1	Z-DSA2-01	248872	1 / 40
2pole OFF	0 - 1	Z-DSA2-01-SL	248873	1 / 40
2pole CO	1 - 2	Z-DSU2-12	248874	1 / 40
2pole CO	1 - 0 - 2	Z-DSU2-102	248875	1 / 40
2pole CO	HA - 0 - AU	Z-DSU2-H0A	248876	1 / 40
3pole CO	1 - 0 - 2	Z-DSU3-102	248877	1 / 40
Voltmeter L-N	L1 - N...	Z-DSV-LN	248878	1 / 40
Voltmeter L-L	L1 - L2...	Z-DSV-LL	248879	1 / 40
Voltmeter L+N	L1 - N3...	Z-DSV-LLLN	248880	1 / 40
Ammeter	0-1-2-3	Z-DSAM-0123	129712	1 / 40

**Description Rotary Switch Z-DS**

- Rotary switches of series Z-DS are of a modular design:  
The switch proper consists of the engaging work and the switching package. The switching cams (for which it is also called cam switch) are driven by a stable, torsion-proof aluminium shaft. The switching package consists of one or several switching cells with one or two independent contacts. Connections of adjoining switch terminals (necessary in case of voltmeter changeover switch Z-DSV) are contained in the pressed switch component. Consequently, there is no obstacle when connecting the connection lines.
- Application:  
Suitable for virtually any application, e.g. motor switch, garage doors, fans, shutters, heating system control, lighting fixtures, instrument switches, different control purposes, etc.



## Technical Data

		<b>Z-DS</b>	
Data according to		IEC 60947-3, IEC 60947-5-1, VDE 0660, EN 60947-3, SEV	
Nominal thermal current			
open	$I_{th}$	20 A	
hermetically enclosed	$I_{thg}$	20 A	
Nominal operational voltage			
Rated peak withstand voltage	$U_e$	690 V	
Disconnecter conditions according to ÖVE, IEC met up to	$U_{imp}$	6 kV	
Circuit breaking capacity			
3 x 220-440V	$I_v$	160 A	
3 x 500 V		100 A	
3 x 660-690V		80 A	
Utilisation category AC21A, AC21B			
Switching resistive loads including low overloads			
Nominal operational current	$I_n$	20 A	
Utilisation category AC23A, AC23B			
Switching motors and other highly inductive loads			
Nominal operational current 400 V	$I_n$	16 A	
Nominal power 220-240 V		4 kW	
3phase 3pole 380-440 V		7.5 kW	
3phase 3pole 500 V		7.5 kW	
3phase 3pole 660-690 V		7.5 kW	
Star-delta starting switch			
for squirrel cage motors			
Nominal power			
3phase 3pole 220-240 V		3.7 kW	
3phase 3pole 380-415 V		7.5 kW	
Utilisation category AC3			
Switching of 3phase AC motors			
Nominal operational current 400 V	$I_n$	12 A	
Nominal power 220-240 V		3 kW	
3phase 3pole 380-440 V		5.5 kW	
3phase 3pole 500 V		5.5 kW	
3phase 3pole 660-690 V		5.5 kW	
Utilisation category AC15			
Switching of electromagnetic drives, contactors, valves, pull-type electromagnets			
Nominal operational current to 240 V	$I_n$	6 A	
Nominal operational current 380-440 V	$I_n$	4 A	
2pole disconnection 500 V		5 A	
Utilisation category DC21A, DC21B			
Switching of resistive loads, time constant L/R ≤ 1 ms			
Nominal operational current	$I_n$	20 A	
1pole 30 V		4 A	
1pole 60 V		0.6 A	
1pole 110 V		0.3 A	
1pole 220 V		-	
1pole 440 V		-	
Utilisation category DC3 - DC5			
Switching of shunt motors and series motors, time constant L/R ≤ 15 ms			
Nominal operational current	$I_n$	8 A	
1pole 30 V		1 A	
1pole 60 V		0.3 A	
1pole 110 V		-	
Terminal capacity			
one or several wires		1 - 2.5 mm <sup>2</sup>	
fine-wire		0.75 - 2.5 mm <sup>2</sup>	
fine wires with wire end sleeve		0.75 - 1.5 mm <sup>2</sup>	
terminal screw		M3.5	
number of conductors per terminal		2	

**Technical Data (continue page)**

		<b>Z-DS</b>
Switching of capacitive load		
maximum making capacity up to 500 V		140 A
Degree of protection from behind		
		IP20
Short circuit protection		
max. fuse gL (gG)		20 A
Rated short-time withstand current (1 second current)		250 A
Conditional rated short circuit current		10 kA <sub>r.m.s.</sub>
Short-time load capacity		
Load duration (values applicable to already closed contacts only)		
3 s		100 A
10 s		60 A
30 s		35 A
60 s		25 A

**Rotary Switch Z-DS for Lighting Systems**

		<b>Z-DS</b>
Utilisation category AC1		
Rated operational current 60 °C	$I_{eAC1}$	20 A
Utilisation category AC5a		
Rated operational power $\cos\varphi$ 0.5		1.1 kW
Rated operational power 220-240 V~ $\cos\varphi$ 0.9		0.4 A
Rated operational power DUO		3 kW
Utilisation category AC5b		
 Rated operational power 220-240 V~		1.4 kW

**Incandescent Lamps**

Utilisation category AC5b	Power	Current	Z-DS
Incandescent Lamps AC5B	W	A	max. number of lamps per current path at 230 V, 50 Hz
	60	0.27	22
	100	0.45	13
	200	0.91	7
	300	1.36	4
	500	2.27	3
	1000	4.5	1

**Fluorescent Tubes, Mercury Arc Lamps**

Utilisation category AC5a	Power	Current	Capacitor	Z-DS
Lamp Types	W	A	µF	max. number of lamps per current path at 230 V, 50 Hz
Fluorescent tubes without compensation or with series compensation	11	0.16	-	60
	18	0.37	2.7	25
	24	0.35	2.5	25
	36	0.43	3.4	20
	58	0.67	5.3	14
	65	0.67	5.3	13
	85	0.8	-	11
Fluorescent tubes lead-lag circuit	11	0.07	-	2 x 100
	18	0.11	-	2 x 50
	24	0.14	-	2 x 40
	36	0.22	-	2 x 30
	58	0.35	-	2 x 20
	65	0.35	-	2 x 15
	85	0.47	-	2 x 10
Fluorescent tubes with parallel compensation	11	0.16	2.0	30
	18	0.37	2.0	20
	24	0.35	3.0	15
	36	0.43	4.5	10
	58	0.67	7.0	6
	65	0.67	7.0	5
	85	0.8	8.0	4
Fluorescent tubes with electronic ballast	18	0.09	-	40
	36	0.16	-	20
	58	0.25	-	15
	2 x 18	0.17	-	2 x 20
	2 x 36	0.32	-	2 x 10
	2 x 58	0.49	-	2 x 7
Mercury arc lamps, high pressure without compensation e.g.: HQL, HPL	50	0.61	-	16
	80	0.8	-	12
	125	1.15	-	8
	250	2.15	-	4
	400	3.25	-	3
	700	5.4	-	1
	1000	7.5	-	1
Mercury arc lamps, high pressure with compensation e.g.: HQL, HPL	50	0.28	7	7
	80	0.41	8	5
	125	0.65	10	3
	250	1.22	18	2
	400	1.95	25	1
	700	3.45	45	1
	1000	4.8	60	-

**Metal Halide Lamps**

Lamp Types	Power W	Current A	Capacitor µF	Z-DS max. number of lamps per current path at 230 V, 50 Hz
Metal halide lamps without compensation e.g. HQI, HPI	35	0.53	-	22
	70	1	-	12
	150	1.8	-	6
	250	3	-	4
	400	3.5	-	3
	1000	9.5	-	1
	2000	16.5	-	-
Metal halide lamps with compensation e.g. HQI, HPI	35	0.25	6	8
	70	0.45	12	4
	150	0.75	20	2
	250	1.5	33	1
	400	2.1	35	1
	1000	5.8	95	-
	2000	11.5	148	-
Transformers for low-voltage halogen lamps	20	-	-	40
	50	-	-	20
	75	-	-	13
	100	-	-	10
	150	-	-	7
	200	-	-	5
	300	-	-	3

**Sodium Vapour Lamps**

Lamp Types	Power W	Current A	Capacitor µF	Z-DS max. number of lamps per current path at 230 V, 50 Hz
Sodium vapour lamps low-pressure without compensation	35	1.5	-	7
	55	1.5	-	7
	90	2.4	-	4
	135	3.5	-	3
	150	3.3	-	3
	180	3.3	-	3
	200	3.3	-	3
Sodium vapour lamps low-pressure with compensation	35	0.31	20	3
	55	0.42	20	2
	90	0.63	30	1
	135	0.94	45	1
	150	1	40	1
	180	1.16	40	1
	200	1.32	25	1
Sodium vapour lamps high-pressure without compensation	150	1.8	-	5
	250	3	-	4
	330	3.7	-	3
	400	4.7	-	2
	1000	10.3	-	1
Sodium vapour lamps high pressure with compensation	150	0.83	20	2
	250	1.5	33	2
	330	2	40	1
	400	2.4	48	1
	1000	6.3	106	-



### Connection diagram

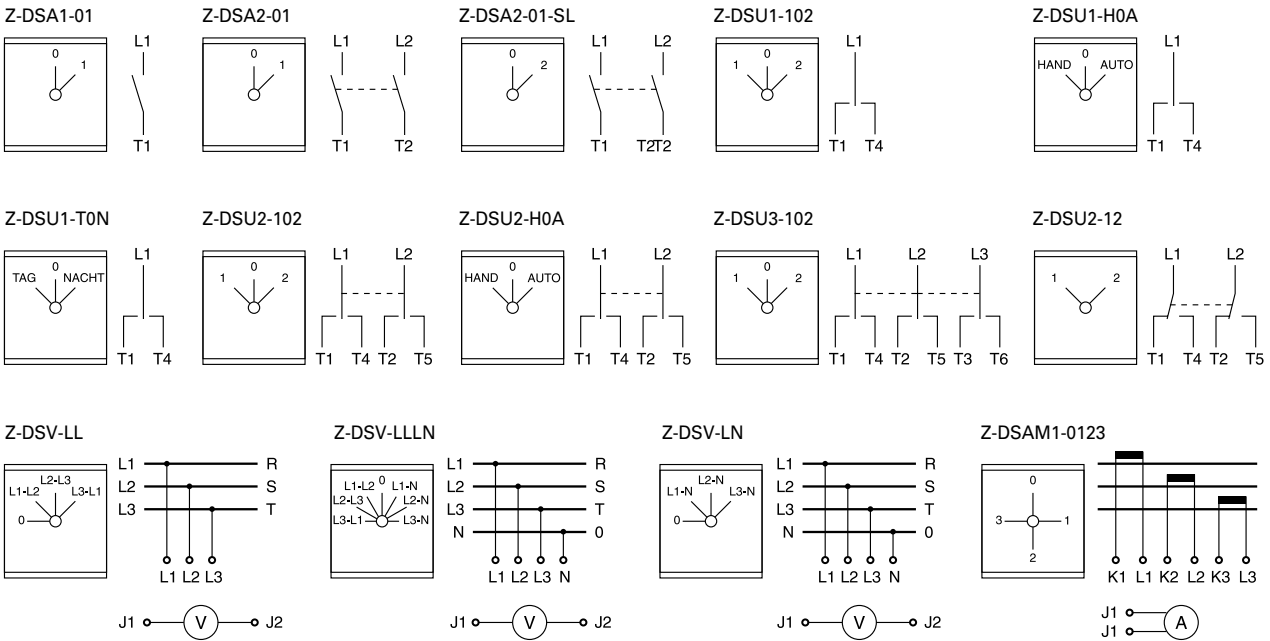

### Dimensions (mm)

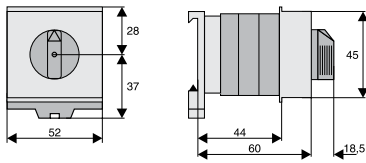



#### Description Installation Relays Z-R

Installation relays Z-R are suitable for switching 1-phase consumers up to 16 A. These devices for universal use in building installations and systems permit implementation of the following applications and control functions:

- Switching lighting systems and electrical heating systems
- Switching ventilation and air conditioning systems, fans
- Switching heat pumps
- Switching electrically controlled roller doors/gates, and blinds
- Switching incandescent lamps and gas discharge lamps

The installation relays of series Z-R meet the requirements of standards EN/IEC 60947.

**EN/IEC 60947** deals with „Electromagnetic contactors in electrical system manufacturing“.

#### Security:

- Manually operable test button on device for testing purpose
- All terminals - coil and contacts - equipped with guide for secure terminal connection. Misplacement of wires impossible.
- Main contacts can be connected to standard pin busbar
- Made of hardly flammable materials and plastics free from chlorine and halogens
- Finger and hand touch safe according to VBG4

#### Advantages:

- Low power loss
- No humming
- Optical operating status display by means of LED
- Low switching noise
- Easy to connect thanks to large terminals supplied open
- Simple snap-on fastening on 35 mm DIN rail
- High degree of flexibility thanks to a variety of contact configurations
- Easy access for coil feed connection

#### Connection diagrams

##### 1MU

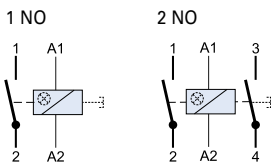

#### Version

with manual operation and LED



#### Dimensions (mm)

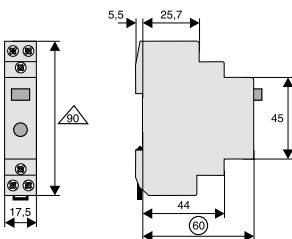

#### Permitted installation positions

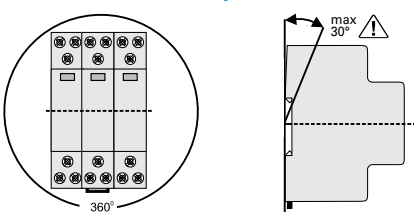

#### Packing density

Spacers recommended! (Z-DST)

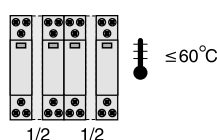

## Technical Data

		Z-R
<b>Electrical</b>		
Standard according		IEC/EN 60947-4-1
Rated voltage		1p: 240 V AC
Rated operational current AC1	$I_e$	16 A
Rated operational power	$P_e$	3.8 kW
Number of poles		1, 2
Main contacts		
NO/NC		1/2
<b>Control circuit</b>		
Rated control feed voltage	$U_s$	
AC		24, 230, 240 V
DC		24 V
Minimum operational voltage	$U_{min}$	
230, 240 V AC		184 V AC
24 V AC		19.2 V AC
24 V DC		16.8 V DC
Rated frequency		50/60 Hz
Operating range		0.85-1.1 x $U_s$
Maximum power of coils retaining		
24, 230, 240 V AC		0.75 W per pole
24 V DC		0.4 W per pole
Minimum command duration		> 50 ms
Operating noise		no humming
Rated peak withstand voltage (1.2/50 $\mu$ s)	$U_{imp}$	2.5 kV
Duty		100%
<b>Load Circuit</b>		
Rated operational voltage	$U_e$	240 V
Rated frequency		50/60 Hz
Rated insulation voltage	$U_i$	240 V
Rated peak withstand voltage (1.2/50 $\mu$ s)	$U_{imp}$	2.5 kV
Conventional thermal current	$I_{th}$	16 A
Rated operational current	$I_e$	16 A
Rated constant current	$I_u$	16 A
Rated current DC	$I_e$	
24 V		16 A
48 V		1.2 A
120 V		0.22 A
250 V		0.1 A
Conditional rated short circuit current	$I_q$	1 kA (with 16 A gL/gG)
Duration of bouncing		< 10 ms (typ. < 5 ms)
Max. peak inrush current		42 A
<b>Mechanical</b>		
Frame size		45 mm
Device height		90 mm
Device width		17.5 mm (1MU)
Mounting		quick fastening on DIN rail IEC/EN 60715
Degree of protection, built-in		IP20
Degree of protection, built-in behind panel		IP40
Mounting position		works in any position, however not hanging
Upper and lower terminals		lift terminals (captive) M4 (combination head), captive screw
Terminal capacity		
Contact and coil		1 x (0.5...10) mm <sup>2</sup> one- or more wire 1 x (0.5...6) mm <sup>2</sup> fine wires with wire end sleeve
Temperature range		-5 to +40 °C
Total contact gap		0.6 mm
Contact material		does not contain cadmium
Endurance		
electrical components		$I = 16$ A AC: > 700.000 switching operations
mechanical components		> 1.000.000 switching operations



Utilisation categories	Z-R		
AC-1 (△/△/ *)			
Rated operational voltage	$U_e$	240 V AC	
Rated operational current	$I_e$	16 A AC	
Rated operational power AC-1		3072 W ( $\cos\varphi = 0.8$ )	
AC-3 (⊙)			
Rated operational voltage	$U_e$	240 V AC	
Rated operational current	$I_e$	3 A AC	
Rated operational power AC-3		324 W ( $\cos\varphi = 0.45$ )	
AC-5a (⊗)			
Rated operational voltage	$U_e$	240 V AC	
Rated operational current	$I_e$	5 A AC	
Rated operational power AC-5a		540 W ( $\cos\varphi = 0.45$ )	
AC-5b (⊗)			
Rated operational voltage	$U_e$	240 V AC	
Rated operational current	$I_e$	3 A AC	
Rated operational power AC-5b		720 W	
AC-7a (according to EN 61095) (■)			
Rated operational voltage	$U_e$	240 V AC	
Rated operational current	$I_e$	10 A AC	
Rated operational power AC-7a		1920 W ( $\cos\varphi = 0.8$ )	
Make-/break-current AC-7a	$I_c$	24 A AC	

### Max. number of lamps

Lamp Types	Power	Current	Capacitor	Z-R
	W	A	μF	max. number of lamps per current path at 230 V, 50 Hz
Incandescent Lamps	60	0.27	-	11
Low-voltage halogen lamps (12 or 24 V) with transformer / electronic transformer	50	0.22	-	7
	75	0.33	-	4
	100	0.43	-	3
	150	0.65	-	2
	200	0.87	-	1
	300	1.3	-	1
Fluorescent tubes without compensation or with series compensation	11	0.16	0.4	20
	18	0.37	0.9	9
	24	0.35	0.8	9
	36	0.43	1.1	8
	58	0.67	1.8	5
	65	0.67	1.8	4
	85	0.8	1.8	3
Fluorescent tubes lead-lag circuit	11	0.07	-	2 x 23
	18	0.11	-	2 x 15
	24	0.14	-	2 x 11
	36	0.22	-	2 x 7
	58	0.35	-	2 x 4
	65	0.35	-	2 x 4
	85	0.47	-	2 x 3
Fluorescent tubes with parallel compensation	11	0.16	1.0	11
	18	0.37	1.3	8
	24	0.35	1.3	8
	36	0.43	1.3	8
	58	0.67	2.3	4
	65	0.67	2.3	4
	85	0.8	2.7	4
Fluorescent tubes with electronic ballast	18	0.09	-	10
	36	0.16	-	5
	58	0.25	-	4
	2 x 18	0.17	-	5
	2 x 36	0.32	-	2
	2 x 58	0.49	-	2

---

**LED Lamps**

Type of lamps	Z-R
LED Lamps. Pay attention on the inrush current of the ballast and $\cos\varphi$ of the lamp	max. permissible inrush current of installation relay [A]  42 A  $\frac{\text{Max. Inrush current installation relay [A]}}{\text{Inrush current lamp [A]}} = \text{max. number of lamps per pole } (I_{nLED} \leq I_{th})$

---

### Installation Relays Z-TN

Control Voltage	Function	MU	Type Designation	Article No.	Units per package
-----------------	----------	----	------------------	-------------	-------------------

#### Installation Relays Type Z-TN

- with manual pre-selection of functions - permanently ON / AUTOM / OFF
- 20 A 250 V AC 

SG59711



Z-TN230/S0

230 V, 50 Hz	2NO	1	Z-TN230/SS	265574	2 / 120
230 V, 50 Hz	3NO	2	Z-TN230/3S	265576	1 / 60
230 V, 50 Hz	4NO	2	Z-TN230/4S	265579	1 / 60
230 V, 50 Hz	1NO+1NC	1	Z-TN230/1S10	267975	2 / 120
230 V, 50 Hz	2NO+2NC	2	Z-TN230/2S20	103168	1 / 60
24 V, 50 Hz	2NO	1	Z-TN24/SS	267976	2 / 120
24 V, 50 Hz	3NO	2	Z-TN24/3S	267977	1 / 60
24 V, 50 Hz	4NO	2	Z-TN24/4S	267978	1 / 60
24 V, 50 Hz	1NO+1NC	1	Z-TN24/1S10	267979	2 / 120

SG60111



Z-TN230/3S

Description	Type Designation	Article No.	Units per package
-------------	------------------	-------------	-------------------

#### Accessories

Spacer 0.5MU	Z-DST	248949	10
--------------	-------	--------	----

**Description Installation Relays Z-TN**

Installation relays Z-TN are suitable for switching 1-phase or 3-phases consumers up to 20 A. These devices for universal use in building installations and systems permit implementation of the following applications and control functions:

- Switching lighting systems and electrical heating systems
- Switching ventilation and air conditioning systems, fans
- Switching heat pumps
- Switching electrically controlled roller doors/gates, and blinds
- Switching incandescent lamps and gas discharge lamps

The installation relays of series Z-TN meet the requirements of standards EN/IEC 60947 and EN/IEC 1095.

**EN/IEC 1095** deals with „Electromechanical contactors for household and similar purposes.“ Compliance with this standard means meeting very high demands in terms of safety for humans and property.

**EN/IEC 60947** deals with „Electromagnetic contactors in electrical system manufacturing“.

**Security:**

- Manual operation
- All terminals - coil and contacts - equipped with guide for secure terminal connection. Misplacement of wires impossible.
- Main contacts can be connected to standard pin busbar
- Made of hardly flammable materials and plastics free from chlorine and halogens
- Finger and hand touch safe according to VBG4

**Advantages:**

- Low switching noise
- Easy to connect thanks to large terminals supplied open
- Simple snap-on fastening on 35 mm DIN rail
- High degree of flexibility thanks to a variety of contact configurations
- Easy access for coil feed connection
- Version with mechanical pre-selection of functions ON/AUTO/OFF
  - ON/permanently ON: Contact permanently ON until a control pulse is switched on and OFF again. Then, the relay reverts to the AUT position.
  - AUT/AUTOMATIC: Standard relay function by control voltage at the coil.
  - OFF/permanently OFF: Contacts permanently OFF, independently of the control voltage at the coil.
- Only in AC

**Connection diagrams**

**1MU**

“SS”  
2 NO

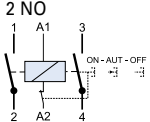

“SO”  
1 NO / 1 NC

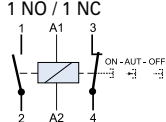

**2MU**

“2S2O”  
2 NO / 2 NC

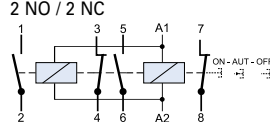

**Versions**

with mech. pre-selection



**2MU**

“3S”  
3 NO

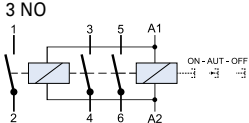

“4S”  
4 NO

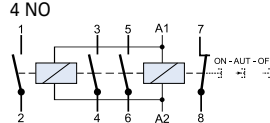

**Dimensions (mm)**

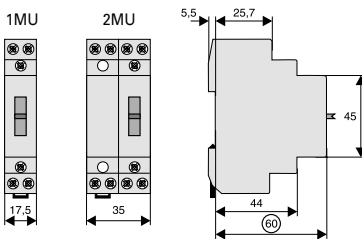

**Permitted installation positions**

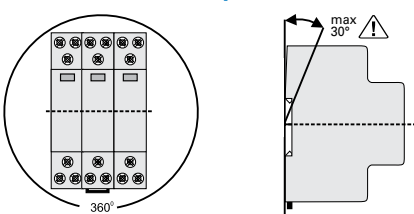





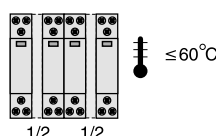







**Packing density**

Spacers recommended! (Z-DST)



## Technical Data

		Z-TN
<b>Electrical</b>		
Standard according		IEC/EN 60947
Rated voltage		250 V, 240/415 V AC
Rated current 250 V AC		20 A
Rated current AC1	$I_e$	20 A 
Rated operational power	$P_e$	4.6 kW 415 V
Number of poles		1 to 4
Main contacts		
NO/NC		1/2 (1MU), 3/4 (2MU)
EMC-Environment		B
<b>Control circuit</b>		
Rated control feed voltage	$U_s$	
AC		8, 12, 24, 48, 110, 230, 240 V
DC		8, 12, 24, 110 V
Rated frequency		50 Hz
Operating range		0.85-1.1 x $U_s$
Maximum power of coils		
pick-up		10-13 VA, 6-8 W
retaining		3.4-4.0 VA, 2.0-2.4 W
Minimum command duration		> 50 ms
Operating noise		low noise
Rated peak withstand voltage (1.2/50 $\mu$ s)	$U_{imp}$	2 kV
Duty		100%
<b>Load Circuit</b>		
Rated operational voltage	$U_e$	
1p, 2p		250 VAC
3p, 4p		240/415 VAC
Minimum operational voltage	$U_{min}$	24 V AC/DC ( $U_s$ 8-110 V)
Rated insulation voltage	$U_i$	500 V
Rated peak withstand voltage (1.2/50 $\mu$ s)	$U_{imp}$	4 kV
Conventional thermal current	$I_{th}$	20 A AC
Rated operational current	$I_e$	20 A AC
Rated constant current	$I_u$	20 A AC
Rated current DC	$I_e$	
24 V		16 A
48 V		12.5 A
230 V		1 A
Conditional rated short circuit current	$I_q$	10 kA (with 20 A gL/gG)
Duration of bouncing		< 10 ms (typ. < 5 ms)
<b>Mechanical</b>		
Frame size		45 mm
Device height		90 mm
Device width		17.5 mm (1MU)
Mounting		quick fastening on DIN rail IEC/EN 60715
Degree of protection, built-in		IP20
Mounting position		works in any position, however not hanging
Upper and lower terminals		lift terminals (captive)
Terminal capacity		
Contact and coil		0.5 - 10 mm <sup>2</sup> one- or more wire 0.5 - 6 mm <sup>2</sup> fine wires with wire end sleeve
Temperature range		-20 to +45 °C
Total contact gap		> 5 mm / independent contacts
Contact material		does not contain cadmium
Endurance		
electrical components		$\geq 40 \times 10^3$ switching operations
mechanical components		$\geq 1 \times 10^6$ switching operations

Utilisation categories 1MU, 2MU (except 3 NO, 4 NO)	Z-TN	
AC-1  *)		
Rated operational voltage	$U_e$	250 V AC
Rated operational current	$I_e$	20 A AC
Rated operational power AC-1		4000 W ( $\cos\varphi = 0.8$ ), 5000 VA
AC-3 		
Rated operational voltage	$U_e$	250 V AC
Rated operational current	$I_e$	8 A AC
Rated operational power AC-3		4000 W ( $\cos\varphi = 0.45$ ), 2000 VA
AC-5a 		
Rated operational voltage	$U_e$	250 V AC
Rated operational current	$I_e$	10 A AC
Rated operational power AC-5a		1125 W ( $\cos\varphi = 0.45$ ), 2500 VA
AC-5b 		
Rated operational voltage	$U_e$	230 V AC
Rated operational current	$I_e$	8.8 A AC
Rated operational power AC-5b		2024 W
AC-7a (according to EN 61095) 		
Rated operational voltage	$U_e$	250 V AC
Rated operational current	$I_e$	20 A AC
Rated operational power AC-7a		4000 W ( $\cos\varphi = 0.8$ ), 5000 VA
<b>Utilisation categories 2MU (3 NO, 4 NO)</b>		
AC-1  *)		
Rated operational voltage	$U_e$	240/415 V AC
Rated operational current	$I_e$	20 A AC
Rated operational power AC-1		4000 W ( $\cos\varphi = 0.8$ ), 5000 VA
AC-3 		
Rated operational voltage	$U_e$	240/415 V AC
Rated operational current	$I_e$	8 A AC
Rated operational power AC-3		900 W ( $\cos\varphi = 0.45$ ), 2000 VA
AC-5a 		
Rated operational voltage	$U_e$	240/415 V AC
Rated operational current	$I_e$	10 A AC
Rated operational power AC-5a		1125 W ( $\cos\varphi = 0.45$ ), 2500 VA
AC-5b 		
Rated operational voltage	$U_e$	230/400 V AC
Rated operational current	$I_e$	8.8 A AC
Rated operational power AC-5b		2024 W
AC-7a (according to EN 61095) 		
Rated operational voltage	$U_e$	240/415 V AC
Rated operational current	$I_e$	20 A AC
Rated operational power AC-7a		4000 W ( $\cos\varphi = 0.8$ ), 5000 VA
AC-7b (according to EN 61095) 		
Rated operational voltage	$U_e$	240/415 V AC
Rated operational current	$I_e$	10 A AC
Rated operational power AC-7b		1125 W ( $\cos\varphi = 0.8$ ), 2500 VA

 \*) suitable for insulation, tested on AC-1

**Max. number of lamps**

Lamp Types	Power	Current	Capacitor	<b>Z-TN</b>
	W	A	µF	max. number of lamps per current path at 230 V, 50 Hz
Incandescent Lamps	60	0.27	-	33
Low-voltage halogen lamps (12 or 24 V) with transformer / electronic transformer	20	0.09	-	55
	50	0.22	-	22
	75	0.33	-	14
	100	0.43	-	11
	150	0.65	-	7
	200	0.87	-	5
	300	1.3	-	3
Fluorescent tubes without compensation or with series compensation	11	0.16	1.3	62
	18	0.37	2.7	27
	24	0.35	2.5	27
	36	0.43	3.4	24
	58	0.67	5.3	15
	65	0.67	5.3	14
	85	0.8	5.3	12
Fluorescent tubes lead-lag circuit	11	0.07	-	2 x 71
	18	0.11	-	2 x 45
	24	0.14	-	2 x 35
	36	0.22	-	2 x 22
	58	0.35	-	2 x 14
	65	0.35	-	2 x 14
	85	0.47	-	2 x 10
Fluorescent tubes with parallel compensation	11	0.16	3.0	34
	18	0.37	4.0	26
	24	0.35	4.0	26
	36	0.43	4.0	26
	58	0.67	7.0	14
	65	0.67	7.0	14
	85	0.8	8.0	13
Fluorescent tubes with electronic ballast	18	0.09	-	32
	36	0.16	-	16
	58	0.25	-	12
	2 x 18	0.17	-	16
	2 x 36	0.32	-	8
	2 x 58	0.49	-	6

sg05617\_r



U <sub>c</sub>	Rating	Function	Type Designation	Article No.	Units per package
<b>Installation Contactors, 20A</b>					
24 V AC/DC	20 A	1NO + 1NC	CR2011024	135171	1
24 V AC/DC	20 A	2NO	CR2020024	135177	1
24 V AC/DC	20 A	2NC	CR2002024	176469	1
12 V AC/DC	20 A	1NO + 1NC	CR2011012	193906	1
12 V AC/DC	20 A	2NO	CR2020012	135175	1
12 V AC/DC	20 A	2NC	CR2002012	193907	1
8 V AC/DC	20 A	1NO + 1NC	CR2011008	193909	1
8 V AC/DC	20 A	2NO	CR2020008	193908	1

Description	Type Designation	Article No.	Units per package
-------------	------------------	-------------	-------------------

**Accessories**

Spacer 0.5MU	Z-DST	248949	10
--------------	-------	--------	----



#### Description Installation Contactors CR

Contactors are frequently applied for switching of lamp loads, fans or pumps in both utility as well as industrial areas. All contactors with AC/DC coils ensure silent operation which is further enhanced by a low power consumption. Optimal contacts and low heat dissipation guarantee a long lifetime of the contactor.

#### Technical characteristics:

- Designed according to IEC 60947-4-1 and IEC 61095 standards
- Suitable for applications in general control, heating & lighting applications
- Available in 20 A rating with 2-pole contacts
- Coil voltages: 8 V AC/DC, 12 V AC/DC, 24 V AC/DC
- DIN modular profile
- Spacers available to extend lifetime (it is recommended to use 1 spacer between every 2 contactors installed)

#### Advantages:

- Low inrush power for all AC/DC types
- Availability of combined AC/DC type contactors ensure silent operation
- Contactors of AC/DC coil type are operable on both AC and DC voltage
- All combined AC/DC type versions are equipped with surge protection on the operating coil
- Equipped with contact indication
- Optimal quality of contacts and low heat dissipation ensure a long life time

#### Connection diagrams

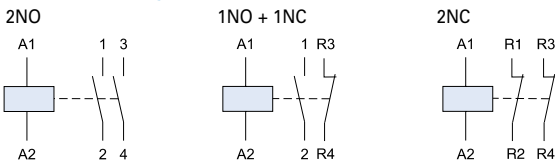

#### Dimensions (mm)

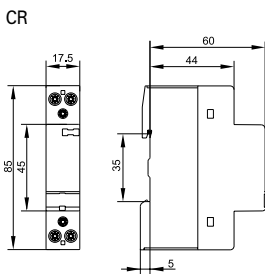

#### Permitted installation positions

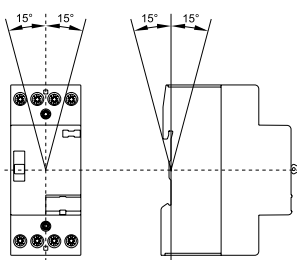

#### Packing density

Spacers recommended! (Z-DST)

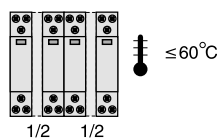

## Technical Data

		CR
<b>General</b>		
Standards		IEC 60947-4-1, IEC 61095
Nominal operating voltage	$U_e$	230 V
Mechanical endurance		3,000,000 switching cycles
Protection class (according to DIN 40 050, IEC 529)		IP20
Permissible ambient temperature		-5 °C up to 55 °C
Storage temperature		-30 °C up to +80 °C
<b>Contact rating</b>		
Rated insulation voltage	$U_i$	230 V
Frequency		50 - 60 Hz
Rated impulse withstand voltage	$U_{imp}$	4 kV
Rated thermal current	$I_{th}$	20 A
AC1 / AC7a Rated operational current	$I_e$	20 A
AC1 / AC7a Operational power rating at $U_e = 230$ VAC	$P_{max}$	4 kW
AC3 / AC7b Operational power rating at $U_e = 230$ VAC	$P_{max}$	NO: 1.3 kW; NC: 0.75 kW
DC1 (L/R ≤ 1 ms) Rated thermal current		
1-pole:		
at $U_e = 24$ V DC		20 A
at $U_e = 110$ V DC		6 A
at $U_e = 220$ V DC		0,6 A
2-poles in series:		
at $U_e = 24$ V DC		20 A
at $U_e = 110$ V DC		10 A
at $U_e = 220$ V DC		6 A
<b>Electrical endurance</b>		
AC1 / AC7a Application		200,000 maximum operating cycles
AC3 / AC7b Application		300,000 maximum operating cycles
AC-1/AC-3/AC-5b/AC-6b/AC-15		600 maximum operating cycles per hour
Power dissipation per contact at $I_n$		1.7 W
<b>Operating coil</b>		
Coil inrush power (for all voltage ratings)		2.5 W
Coil consumption (for all voltage ratings)		2.5 W
Closing delay		15 – 45 ms
Opening delay		20 – 50 ms
Range of control voltage	$U_c$	85 up to 110%
Kind of voltage		AC / DC
Frequency (AC)		50/60 Hz
<b>Dimensions</b>		
Width		17.5 mm
Height		85 mm
Depth		65 mm
<b>Terminals for main</b>		
Terminal capacity - fine stranded wire		1 to 6 mm <sup>2</sup>
Terminal capacity - solid wire		1 to 10 mm <sup>2</sup>
Terminal screw size		M3,5
Terminal screw head type (Pozidrive)		PZ Size 1
Maximum torque		1.2 Nm
<b>Terminals for operating coils</b>		
Terminal capacity - fine stranded wire		1 to 2.5 mm <sup>2</sup>
Terminal capacity - solid wire		1 to 2.5 mm <sup>2</sup>
Terminal screw size		M3,5
Terminal screw head type (Pozidrive)		PZ Size 1
Maximum torque		0.6 Nm

**Fluorescent Tubes, Mercury Arc Lamps**

Lamp Types	Power	Current	Capacitor	CR
	W	A	µF	max. number of lamps per current path at 230 V, 50 Hz
Incandescent lamps and halogen lamps	15	0.07	–	130
	25	0.11	–	80
	40	0.18	–	50
	60	0.26	–	33
	75	0.33	–	26
	100	0.44	–	20
	150	0.65	–	13
	200	0.87	–	10
	300	1.30	–	6
	500	2.17	–	3
Energy saving lamps	1000	4.35	–	1
	3	0.03	–	50
	5	0.04	–	45
	7	0.055	–	40
	8	0.065	–	35
	9	0.075	–	30
	10	0.08	–	30
	11	0.09	–	30
	12	0.1	–	25
	14	0.11	–	25
	15	0.12	–	20
	16	0.13	–	20
	18	0.145	–	18
	20	0.16	–	17
	21	0.17	–	15
	23	0.185	–	15
	24	0.195	–	15
30	0.16	–	15	
Compact fluorescent lamps - series correction	10	0.19	1.4	50
	13	0.18	1.4	50
	18	0.23	1.7	40
	26	0.33	2.5	30
	18	0.38	2.7	25
	24	0.35	2.7	25
Compact fluorescent lamps - parallel correction	36	0.44	3.4	20
	5	0.18	2.2	13
	7	0.18	2.1	14
	9	0.17	2.0	15
	10	0.19	2.2	13
	11	0.16	1.7	17
	13	0.18	1.8	16
	18	0.23	2.3	13
	26	0.33	3.3	9
	18	0.38	4.2	7
Compact fluorescent lamps with electronic control gear (ECG)	24	0.35	3.6	8
	36	0.44	4.4	6
	5	0.05	–	45
	7	0.05	–	45
	9	0.07	–	32
	10	0.07	–	32
	11	0.07	–	32
	13	0.07	–	32
	18	0.22	–	10
	24	0.22	–	10
	26	0.22	–	10
	32	0.22	–	10
	36	0.22	–	10
	40	0.22	–	10
	42	0.22	–	10
55	0.28	–	8	
57	0.28	–	8	
70	0.35	–	6	
80	0.41	–	5	
120	0.58	–	4	

Lamp Types	Power W	Current A	Capacitor µF	CR max. number of lamps per current path at 230 V, 50 Hz
(to be continued)	2 x 9	0.11	–	2 x 16
Compact fluorescent lamps with electronic control gear (ECG)	2 x 10	0.11	–	2 x 16
	2 x 11	0.11	–	2 x 16
	2 x 13	0.11	–	2 x 16
	2 x 18	0.30	–	2 x 5
	2 x 24	0.31	–	2 x 5
	2 x 26	0.31	–	2 x 5
	2 x 32	0.31	–	2 x 5
	2 x 36	0.31	–	2 x 5
	2 x 40	0.40	–	2 x 4
	2 x 42	0.40	–	2 x 4
	2 x 55	0.55	–	2 x 3
	2 x 57	0.55	–	2 x 3
	Fluorescent lamps - uncorrected or series correction	11	0.16	1.3
18		0.37	2.7	22
24		0.35	2.5	22
36		0.43	3.4	17
58		0.67	5.3	14
65		0.67	5.3	14
Fluorescent lamps - lead-lag circuit	2 x 11	0.07	–	2 x 50
	2 x 18	0.11	–	2 x 30
	2 x 24	0.14	–	2 x 24
	2 x 36	0.22	–	2 x 17
	2 x 58	0.35	–	2 x 10
	2 x 65	0.35	–	2 x 9
	2 x 85	0.47	–	2 x 6
Fluorescent lamps - parallel correction	11	0.16	3.5	9
	18	0.37	4.5	7
	24	0.35	4.5	7
	36	0.34	4.5	7
	58	0.67	7.0	4
	65	0.67	7.0	4
Fluorescent lamps with electronic control gear (ECG)	18	0.09	–	25
	36	0.16	–	15
	58	0.25	–	14
	2 x 18	0.17	–	2 x 12
	2 x 36	0.32	–	2 x 7
	2 x 58	0.49	–	2 x 7
High-pressure mercury-vapour lamps - uncorrected	50	0.61	–	14
	80	0.80	–	10
	125	1.15	–	7
	250	2.15	–	4
	400	3.25	–	2
	700	5.40	–	1
High-pressure mercury-vapour lamps - parallel correction	1000	7.50	–	1
	50	0.28	7	4
	80	0.41	8	4
	125	0.65	10	3
	250	1.22	18	1
	400	1.95	25	1
Metal halide lamps - uncorrected	700	3.45	45	–
	35	0.35	–	18
	70	1.00	–	10
	150	1.80	–	5
	250	3.00	–	3
	400	3.50	–	3
	1000	9.50	–	1
Metal halide lamps - parallel correction	2000	16.50	–	–
	35	0.25	6	5
	70	0.45	12	2
	150	0.75	20	1
	250	1.50	33	–

Lamp Types	Power W	Current A	Capacitor µF	CR max. number of lamps per current path at 230 V, 50 Hz
Metal halide lamps with electronic control gear (PCI) + 50-125 x I <sub>n</sub> lamp for 0.6 ms	20	0.10	–	9
	35	0.20	–	6
	70	0.36	–	5
	150	0.70	–	4
High-pressure sodium-vapour lamps - uncorrected	150	1.8	–	5
	250	3.0	–	3
	400	4.7	–	2
	1000	10.3	–	–
High-pressure sodium-vapour lamps - correction	150	0.83	20	1
	250	1.50	33	–
High-pressure sodium-vapour lamps with electronic control gear (PCI) + 50-125 x I <sub>n</sub> lamp for 0.6 ms	20	0.10	–	9
	35	0.20	–	6
	70	0.36	–	5
	150	0.70	–	4
Low-pressure sodium-vapour lamps - uncorrected	18	0.35	–	22
	35	1.50	–	7
	55	1.50	–	7
	90	2.40	–	4
	135	3.50	–	3
	180	3.50	–	3
Low-pressure sodium-vapour lamps - parallel correction	18	0.35	5	6
	35	0.31	20	1
	55	0.42	20	1
	90	0.63	26	1
	135	0.94	45	–
Transformers for low-voltage tungsten halogen lamps	20	–	–	40
	50	–	–	20
	75	–	–	13
	100	–	–	10
	150	–	–	7
	200	–	–	5
	300	–	–	3
Fluorescent lamps T5 with electronic control gear (ECG)	22	0.11	FC	22
	40	0.21	FC	12
	55	0.28	FC	8
	14	0.08	HE	30
	21	0.11	HE	22
	28	0.14	HE	18
	35	0.18	HE	14
	24	0.12	HO	20
	39	0.20	HO	12
	49	0.24	HO	10
	54	0.27	HO	9
	80	0.39	HO	6
	2 x 22	0.23	2 x FC	2 x 11
	2 x 40	0.42	2 x FC	2 x 6
	2 x 55	0.55	2 x FC	2 x 4
	2 x 14	0.15	2 x HE	2 x 15
	2 x 21	0.22	2 x HE	2 x 11
	2 x 28	0.28	2 x HE	2 x 9
	2 x 35	0.36	2 x HE	2 x 7
	2 x 24	0.24	2 x HO	2 x 10
2 x 39	0.39	2 x HO	2 x 6	
2 x 49	0.48	2 x HO	2 x 5	
2 x 54	0.54	2 x HO	2 x 4	
2 x 80	0.74	2 x HO	2 x 3	
LED lamps				
Power supplies for LEDs	max. 2.4 A per pole			

## General remarks:

- In case multiple contactors are installed in one panel it is required to multiply the above mentioned fittings by the applicable load factor according the IEC 60439-1.
- It is recommended to install one spacer between each 2 contactors installed (e.g. contactor, contactor, spacer, contactor, etc.).

U <sub>s</sub>	I <sub>n</sub> AC1	Function	Type Designation	Article No.	Units per package
----------------	--------------------	----------	------------------	-------------	-------------------

**Installation Contactors Z-SCH**

SG84511



Z-SCH230/1/25-20

SG84611



Z-SCH230/25-40

SG84711



Z-SCH230/63-40

230 V AC	25 A	2NO	Z-SCH230/1/25-20	120853	2 / 120
230 V AC	25 A	1NO+1NC	Z-SCH230/1/25-11	193886	2 / 120
230 V AC	25 A	2NC	Z-SCH230/1/25-02	193887	2 / 120
24 V AC	25 A	2NO	Z-SCH24/1/25-20	193885	2 / 120
24 V AC	25 A	1NO+1NC	Z-SCH24/1/25-11	193888	2 / 120
24 V AC	25 A	2NC	Z-SCH24/1/25-02	193984	2 / 120
230 V AC	25 A	4NO	Z-SCH230/25-40	248847	1 / 60
230 V AC	25 A	4NC	Z-SCH230/25-04	248848	1 / 60
230 V AC	25 A	3NO+1NC	Z-SCH230/25-31	248846	1 / 60
230 V AC	25 A	2NO+2NC	Z-SCH230/25-22	248849	1 / 60
24 V AC	25 A	4NO	Z-SCH24/25-40	248851	1 / 60
24 V AC	25 A	2NO+2NC	Z-SCH24/25-22	248850	1 / 60
230 V AC	40 A	4NO	Z-SCH230/40-40	248852	1 / 40
230 V AC	40 A	3NO+1NC	Z-SCH230/40-31	248854	1 / 40
230 V AC	40 A	2NO+2NC	Z-SCH230/40-22	248853	1 / 40
230 V AC	40 A	2NO	Z-SCH230/40-20	248855	1 / 40
230 V AC	63 A	4NO	Z-SCH230/63-40	248856	1 / 40
230 V AC	63 A	4NC	Z-SCH230/63-04	285735	1 / 40
230 V AC	63 A	3NO+1NC	Z-SCH230/63-31	248858	1 / 40
230 V AC	63 A	2NO+2NC	Z-SCH230/63-22	248857	1 / 40
230 V AC	63 A	2NO	Z-SCH230/63-20	248859	1 / 40

**Installation Contactors CMUC**

• Universal Control Voltage U<sub>s</sub> AC/DC

SG28812



CMUC230/25-40

230 V AC/DC	25 A	4NO	CMUC230/25-40	137309	1 / 60
230 V AC/DC	25 A	4NC	CMUC230/25-04	137405	1 / 60
230 V AC/DC	25 A	3NO+1NC	CMUC230/25-31	137401	1 / 60
230 V AC/DC	25 A	2NO+2NC	CMUC230/25-22	137403	1 / 60
24 V AC/DC	25 A	4NO	CMUC24/25-40	137308	1 / 60
24 V AC/DC	25 A	4NC	CMUC24/25-04	137404	1 / 60
24 V AC/DC	25 A	3NO+1NC	CMUC24/25-31	137400	1 / 60
24 V AC/DC	25 A	2NO+2NC	CMUC24/25-22	137402	1 / 60

Description	Type Designation	Article No.	Units per package
-------------	------------------	-------------	-------------------

**Accessories suitable for Z-SCH / CMUC**

SG84311



Z-SC

Sealing cover	Z-SCHAK-2TE	248860	10
Sealing cover	Z-SCHAK-3TE	248861	10
Auxiliary Switch 1NO+1NC for Z-SCH series *)	Z-SC	248862	3
Auxiliary Switch 1NO+1NC for CMUC series	CMUCA	303643	3
Spacer 0.5MU	Z-DST	248949	10
Suppressor RC-Combination 12-250 VAC	Z-RC/230	101428	2 / 120

\*) NOT suitable for Z-SCH.../1/...- types

#### Description Installation Contactors Z-SCH, CMUC

These Installation Contactors are design to cover all applications in residential and commercial sites as for as example:

- Switching of lighting systems
- Switching of electrical heating systems
- Switching of ventilation systems
- Switching of air conditioning systems and fans
- Switching of heat pumps
- Switching of roller doors/gates and blinds
- etc. etc.

#### Advantages and Safety:

- Front-side switch position indicator
- Compact frame
- Large terminals
- Low switching noise
- Z-SCH low noise
- CMUC no humming
- High contact force for high switching capacity
- Simple snap-on fastening of 35 mm DIN rail
- Finger and hand touch safe according to VGB 4
- Hardly flammable materials and chlorine-free and halogen-free plastics are used
- Z-SCH: Innovative AC magnet system
- CMUC: Innovative AC/DC magnet system

These products meets the requirement of the standards IEC/EN 60947-4-1 and IEC/EN 61095

#### Connection diagram

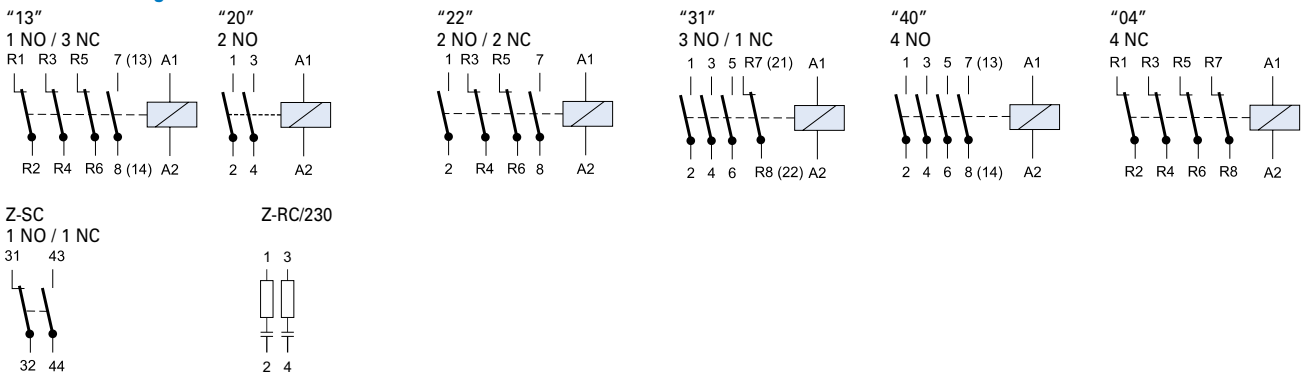

#### Dimensions (mm)

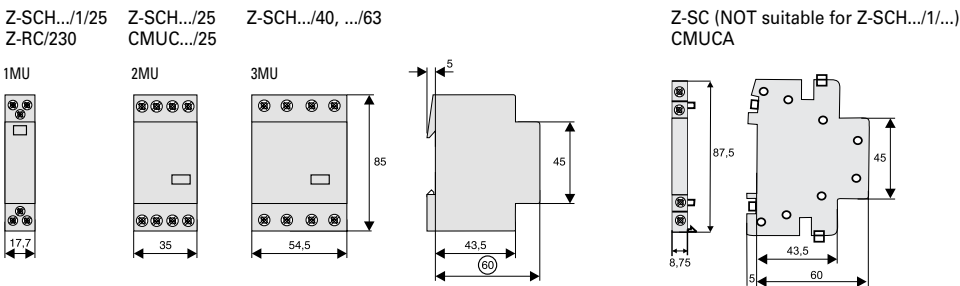

#### Permitted installation positions

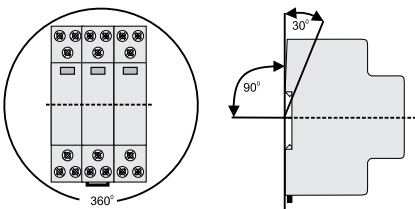

#### Packing Density at full contact load

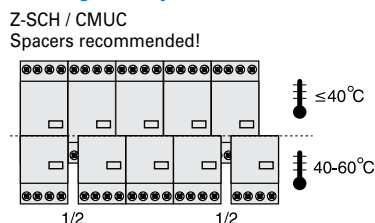

**Technical Data**

		Z-SCH/25/.., CMUC../25/	Z-SCH/40/..	Z-SCH/63/..	Z-SC, CMUCA
Data according to		IEC 61095, EN 61095, VDE 0660, IEC 60947-4-1, EN 60947-4-1, VDE			
Utilisation category AC1 (e.g. heating system)					
Rated operational current (= I <sub>th</sub> )	I <sub>n</sub>	25 A	40 A	63 A	-
open at 60 °C		0.1 S x 10 <sup>6</sup>	0.1 S x 10 <sup>6</sup>	0.1 S x 10 <sup>6</sup>	-
Service life of switching element		9.5 kW	16 kW	25 kW	-
Rated operational power AC1 220 - 240 V		17 kW	27.5 kW	43 kW	-
Rated operational power AC1 380 - 415 V		24 V / 100 mA	24 V / 100 mA	24 V / 100 mA	17 V / 5 mA
Lowest switching power					
Utilisation category AC3 (Switching of 3phase AC motors)					
Rated operational current	I <sub>n</sub>	9 A	27 A	30 A	-
Service life of switching element		0.15 S x 10 <sup>6</sup>	0.15 S x 10 <sup>6</sup>	0.15 S x 10 <sup>6</sup>	-
Rated power of 3phase AC motors 50-60 Hz, 220 V		2.2 kW	7.5 kW	8 kW	-
Rated power of 3phase AC motors 50-60 Hz, 230-240 V		2.5 kW	8 kW	8.5 kW	-
Rated power of 3phase AC motors 50-60 Hz, 380-415 V		4 kW	12.5 kW	15 kW	-
Utilisation category DC1 (Switching of resistive loads, L/R ≤ 15 ms), values for NO contacts					
1pole 24 V DC		25 A	40 A	63 A	-
1pole 48 V DC		22 A	25 A	26 A	-
1pole 60 V DC		18 A	19 A	21 A	-
1pole 110 V DC		5 A	7 A	8 A	-
1pole 220 V DC		0.5 A	0.7 A	0.7 A	-
2pole in series 24 V DC		25 A	40 A	63 A	-
2pole in series 48 V DC		25 A	40 A	44 A	-
2pole in series 60 V DC		25 A	33 A	36 A	-
2pole in series 110 V DC		16 A	17 A	18 A	-
2pole in series 220 V DC		4 A	5 A	6 A	-
3pole in series 24 V DC		25 A	40 A	63 A	-
3pole in series 48 V DC		25 A	40 A	63 A	-
3pole in series 60 V DC		25 A	40 A	61 A	-
3pole in series 110 V DC		25 A	31 A	34 A	-
3pole in series 220 V DC		10 A	15 A	16 A	-
4pole in series 24 V DC		25 A	40 A	63 A	-
4pole in series 48 V DC		25 A	40 A	63 A	-
4pole in series 60 V DC		25 A	40 A	63 A	-
4pole in series 110 V DC		25 A	40 A	63 A	-
4pole in series 220 V DC		15 A	20 A	21 A	-
Utilisation category DC3 and DC5 (Switching of resistive loads, L/R ≤ 15 ms), values for NO contacts					
1pole 24 V DC		15 A	23 A	25 A	-
1pole 48 V DC		5 A	10 A	10 A	-
1pole 60 V DC		4 A	5 A	5 A	-
1pole 110 V DC		1 A	1.5 A	1.5 A	-
1pole 220 V DC		0.1 A	0.3 A	0.3 A	-
2pole in series 24 V DC		25 A	40 A	45 A	-
2pole in series 48 V DC		17 A	23 A	25 A	-
2pole in series 60 V DC		13 A	15 A	15 A	-
2pole in series 110 V DC		5 A	5 A	5 A	-
2pole in series 220 V DC		0.5 A	1 A	1 A	-
3pole in series 24 V DC		25 A	40 A	63 A	-
3pole in series 48 V DC		25 A	40 A	45 A	-
3pole in series 60 V DC		25 A	30 A	30 A	-
3pole in series 110 V DC		15 A	15 A	15 A	-
3pole in series 220 V DC		3 A	4 A	4 A	-
4pole in series 24 V DC		25 A	40 A	63 A	-
4pole in series 48 V DC		25 A	40 A	63 A	-
4pole in series 60 V DC		25 A	40 A	63 A	-
4pole in series 110 V DC		25 A	40 A	45 A	-
4pole in series 220 V DC		8 A	10 A	10 A	-
Main switching elements (U <sub>imp</sub> = 4 kV, Duty Cycle: 100%)					
Rated insulation voltage	U <sub>i</sub>	440 V AC	440 V AC	440 V AC	440 V AC
Rated operational voltage	U <sub>e</sub>	440 V AC	440 V AC	440 V AC	440 V AC
Permissible switching frequency AC1, AC3	z	300 x/h	600 x/h	600 x/h	600 x/h
Endurance mechanical components		1 x 10 <sup>6</sup>	1 x 10 <sup>6</sup>	1 x 10 <sup>6</sup>	1 x 10 <sup>6</sup>



## Technical Data (continue page)

		Z-SCH/25/.., CMUC../25/	Z-SCH/40/..	Z-SCH/63/..	Z-SC, CMUCA
Auxiliary switching elements ( $U_{imp} = 4$ kV, Duty Cycle: 100%)					
Rated insulation voltage	$U_i$	440 V AC	440 V AC	440 V AC	440 V AC
Nominal thermal current = $I_{tr}$ , 40°C		25 A	40 A	63 A	10 A
Nominal thermal current = $I_{tr}$ , 60°C		25 A	40 A	63 A	6 A
Utilisation category AC15 (Controlling of electromagnetic load)					
Rated operational current 220-240 V	$I_e$	-	-	-	3 A
Rated operational current 380-415 V	$I_e$	-	-	-	2 A
Rated operational current 440 V	$I_e$	-	-	-	1.6 A
Utilisation category DC13 (Controlling of electromagnetic load at DC)					
Rated operational current per pole 24-60 V	$I_e$	-	-	-	2 A
Rated operational current per pole 110 V	$I_e$	-	-	-	0.4 A
Rated operational current per pole 220 V	$I_e$	-	-	-	0.1 A
Trip Coil Power					
☒ Z-SCH					
Switching on		14 - 18 VA	33 - 45 VA	33 - 45 VA	-
Holding		4.4 - 8.4 VA	7 VA	7 VA	-
		1.6 - 3.2 W	2.6 W	2.6 W	-
☒☒☒ CMUC					
		3 - 4 W	-	-	-
Operating range of trip coils multiple of $U_e$ (-40 to +40°C)					
☒ Z-SCH					
Coil voltage 50 Hz		24, 220 - 240 V	220 - 240 V	220 - 240 V	-
Coil voltage 60 Hz		24, 230 - 264 V	230 - 264 V	230 - 264 V	-
☒☒☒ CMUC					
Coil voltage 50/60 Hz		24, 220-240 V	-	-	-
DC		24, 220 V	-	-	-
Power loss per current path					
	$P_v$	2 W	3 W	7 W	0.5 W
Power loss per device at nominal current load 1pole	$P_{vges}$	5.2 W	5.6 W	5.6 W	-
Power loss per device at nominal current load 2pole	$P_{vges}$	7.2 W	8.6 W	16.6 W	-
Power loss per device at nominal current load 3pole	$P_{vges}$	9.2 W	11.6 W	23.6 W	-
Power loss per device at nominal current load 4pole	$P_{vges}$	11.2 W	14.6 W	30.6 W	-
Switching noise (on and off), typical mean values					
		80 dB	78 dB	78 dB	-
Terminal capacity					
Main conductor					
one or several wires		1.5 - 10 mm <sup>2</sup>	2.5 - 25 mm <sup>2</sup>	2.5 - 25 mm <sup>2</sup>	0.5 - 2.5 mm <sup>2</sup>
fine-wire		1.5 - 6 mm <sup>2</sup>	2.5 - 16 mm <sup>2</sup>	2.5 - 16 mm <sup>2</sup>	0.5 - 2.5 mm <sup>2</sup>
fine wires with wire end sleeve		1.5 - 6 mm <sup>2</sup>	2.5 - 16 mm <sup>2</sup>	2.5 - 16 mm <sup>2</sup>	0.5 - 1.5 mm <sup>2</sup>
number of conductors per terminal		1	1	1	2
Coil					
one or several wires		0.75 - 2.5 mm <sup>2</sup>	0.75 - 2.5 mm <sup>2</sup>	0.75 - 2.5 mm <sup>2</sup>	-
fine-wire		0.5 - 2.5 mm <sup>2</sup>	0.5 - 2.5 mm <sup>2</sup>	0.5 - 2.5 mm <sup>2</sup>	-
fine wires with wire end sleeve		0.5 - 1.5 mm <sup>2</sup>	0.5 - 1.5 mm <sup>2</sup>	0.5 - 1.5 mm <sup>2</sup>	-
number of conductors per terminal		1	1	1	-
Weight					
		0.22 kg/unit	0.36 kg/unit	0.36 kg/unit	0.026 kg/unit
Tightening torque of terminal screws					
Main contacts					
		0.8 - 1.4 Nm	2.5 - 3.0 Nm	2.5 - 3.0 Nm	-
Coil					
		0.6 - 1.2 Nm	0.6 - 1.2 Nm	0.6 - 1.2 Nm	-
Short circuit protection (main circuit), maximum nominal current of fuse					
Co-ordination type (1), gL (gG)		35 A	63 A	80 A	-
Short circuit protection (auxiliary circuit), maximum nominal current of fuses					
Short-circuit current 1 kA, without fusing of contacts, gL (gG)		-	-	-	10 A
Switching times at control voltage $U_s \pm 10\%$					
Make delay		9 - 15 ms	11 - 15 ms	11 - 15 ms	-
Break delay		4 - 8 ms	6 - 13 ms	6 - 13 ms	-
Arc duration		10 - 15 ms	10 - 15 ms	10 - 15 ms	-
Pollution degree					
		3	3	3	3
Overvoltage category (grounded neutral system)					
		1 - 3	1 - 3	1 - 3	1 - 3

**Installation Contactors Z-SCH, CMUC for Lighting Systems**

The decisive factors are the type, connection and current consumption of lamps during switch-on and in permanent operation. Only 90 % of the continuous current of switching devices should be used in view of higher current consumption as a result of increases of voltage. The maximum number of lamps per phase that can be operated

by a switching device is dependent on the nominal current and making current of lamps on the one hand, and on the continuous current and making capacity of the switching devices on the other. Thus, e.g. in lead-lag circuits, the continuous current of contactors can be used, while this is not possible in fluorescent tubes with separate compensation.

	Z-SCH/25/... CMUC.../25/	Z-SCH/40/..	Z-SCH/63/..	Z-SC, CMUCA
Utilisation category AC1				
Rated operational current	$I_e$ 25 A (60 °C)	40 A (60 °C)	63 A (60 °C)	-
Making capacity root mean square	$I_{r.m.s.}$ 200 A	360 A	480 A	-
Making capacity peak value	$I_{peak}$ 280 A	510 A	680 A	-
Utilisation category AC5a				
Rated operational power 250 V $\cos\phi = 0.45$	1.3 kW	3.4 kW	5.5 kW	-
Rated operational power 220-240 V~ $\cos\phi = 0.90$	1.2 kW	3.1 kW	5.1 kW	-
DUO	3.7 kW	6.3 kW	10 kW	-
Utilisation category AC5b				
 Rated operational power 240V~	3 kW	5.7 kW	8 kW	-

**Incandescent Lamps**

The incandescent lamp filament has a very low ohmic resistance when it is cold. Therefore, when switching on, there is a high peak current (up to 20x  $I_n$ ). When switching off, only the nominal current is switched off.

Utilisation category AC5b	Power	Current	Z-SCH/25/..	Z-SCH/40/..	Z-SCH/63/..	Z-SC
			CMUC.../25/			
	W	A	max. number of lamps per current path at 230 V, 50 Hz			
Incandescent Lamps AC5B (with or except halogen)	60	0.27	50	92	129	-
	 100	0.45	30	55	77	-
	200	0.91	15	27	38	-
	300	1.36	10	19	26	-
	500	2.27	6	11	16	-
	1000	4.5	3	6	8	-
Low voltage halogen lamps (12 or 24V) with transformer (with electronic transformer)	0.09	52	110	174	-	-
	0.22	24	50	80	-	-
	75	0.33	16	35	54	-
	100	0.43	12	27	43	-
	150	0.65	9	19	29	-
	200	0.87	6	14	23	-
	300	1.30	4	9	14	-

**LED Lamps**

Lamp Types		Z-SCH/25/..	Z-SCH/40/..	Z-SCH/63/..	Z-SC
		CMUC.../25/			
LED Lamp. Pay attention on the inrush current of the ballast and $\cos\phi$ of the lamp.	max. permissible inrush current contactor [A]	233	424	565	-
max. number of lamps per current path	$\frac{\text{inrush current contactor [A]}}{\text{inrush current lamp/ballast [A]}}$ = max. number of lamps per current path ( $I_{nLED} \leq I_{th}$ )				

#### Fluorescent Tubes, Mercury Arc Lamps

High- and low pressure discharge lamps with mercury vapour, with or without fluorescent-coated glass body are perfectly identical in their electrical behaviour.

In order to limit the operational current and pre-conduction current, and to achieve the initial peak voltage, reactance coils are used as ballast. Capacitors are used for compensation of the resulting reactive current, which are either connected in series

with the coil (lead-lag circuit) or parallel to the mains (separate compensation, very rarely used now). The high making current in case of separate compensation (max. 30 x nominal current of the capacitor) which goes down quickly is usually attenuated considerably by the feed line.

#### Utilisation category AC5a

I / I <sub>Lampe</sub> = number of connectable lamps per current path	Fluorescent lamps without comp. or with series comp.	$I = I_{eAC1} \times 0.5$
	Lead-lag circuit (2x..)	$I = I_{eAC1} \times 0.35$
	Fluorescent tubes with parallel compensation	$I = I_{peak} / 100$ (take into account compensation capacitor)
	Fluorescent tubes with electronic ballast	$I = I_{peak} / 50$
	Mercury arc lamps, HD without compensation	$I = I_{eAC1} \times 0.5$
	Mercury arc lamps, HD with compensation	$I = I_{peak} / 100$ (take into account compensation capacitor)

Utilisation category AC5a	Power	Current	Capacitor	Z-SCH/25/.. CMUC.../25/	Z-SCH/40/..	Z-SCH/63/..	Z-SC, CMUCA
Lamp Types	W	A	µF	max. number of lamps per current path at 230 V, 50 Hz			
Fluorescent tubes without compensation or with series compensation	11	0.16	1.3	75	210	310	-
	18	0.37	2.7	34	90	140	-
	24	0.35	2.5	34	90	140	-
	36	0.43	3.4	30	70	140	-
	58	0.67	5.3	20	45	70	-
	65	0.67	5.3	19	40	65	-
	85	0.8	5.3	16	35	60	-
Fluorescent tubes lead-lag circuit	11	0.07	-	2 x 110	2 x 220	2 x 250	-
	18	0.11	-	2 x 55	2 x 130	2 x 200	-
	24	0.14	-	2 x 44	2 x 110	2 x 160	-
	36	0.22	-	2 x 33	2 x 70	2 x 100	-
	58	0.35	-	2 x 22	2 x 46	2 x 70	-
	65	0.35	-	2 x 16	2 x 40	2 x 60	-
	85	0.47	-	2 x 11	2 x 30	2 x 40	-
Fluorescent tubes with parallel compensation	11	0.16	3.0	43	67	107	-
	18	0.37	4.0	32	50	80	-
	24	0.35	4.0	32	50	80	-
	36	0.43	4.0	32	50	80	-
	58	0.67	7.0	18	36	46	-
	65	0.67	7.0	18	36	46	-
	85	0.8	8.0	16	33	44	-
Fluorescent tubes with electronic ballast	18	0.09	-	40	100	150	-
	36	0.16	-	20	50	75	-
	58	0.25	-	15	30	55	-
	80	0.4	-	10	20	30	-
	2 x 18	0.17	-	20	50	60	-
	2 x 36	0.32	-	10	25	30	-
	2 x 58	0.49	-	7	15	20	-
Mercury arc lamps, high pressure without compensation e.g.: HQL, HPL	50	0.61	-	21	38	55	-
	80	0.8	-	16	28	40	-
	125	1.15	-	11	20	28	-
	250	2.15	-	6	11	15	-
	400	3.25	-	4	7	10	-
	700	5.4	-	2	4	6	-
	1000	7.5	-	1	3	4	-
Mercury arc lamps, high pressure with compensation e.g.: HQL, HPL	50	0.28	7	18	36	50	-
	80	0.41	8	16	31	44	-
	125	0.65	10	13	25	35	-
	250	1.22	18	7	14	19	-
	400	1.95	25	5	10	14	-
	700	3.45	45	3	6	8	-
	1000	4.8	60	2	4	6	-

**Metal Halide Lamps**

Metal halide lamps are a version of high-pressure mercury arc lamps with higher luminous efficiency and fidelity of colour (metalloids [halogens] added to the mercury fill up the Hg-spectrum with its many gaps). Ballast and ignition devices are necessary. Starting time 3 ... 5 minutes at 1.4 - 2 x I. After switching on, it is not possible to light the lamp again immediately (lamp extinguishes after a power cut-off of only 1/2 period). Therefore, in many cases in important

facilities ionisation of part of the lamps is maintained by switching over to 415 V, 500 Hz (e.g. to an emergency power supply). In this case, the lamp lights immediately after the mains voltage is on again. Otherwise, this would take several minutes. When using suitable ignition devices, the lamps can be lit again immediately.

I / I <sub>Lampe</sub> = number of connectable lamps per current path	Metal halide lamps (HQI) without compensation	$I = I_{eAC1} \times 0.5$
	Metal halide lamps (HQI) with compensation	$I = I_{peak} / 100$ (take into account compensation capacitor)
	Transformer for low voltage halogen lamps	$I = I_{peak} / 50$

Lamp Types	Power	Current	Capacitor	Z-SCH/25/.. CMUC.../25/	Z-SCH/40/..	Z-SCH/63/..	Z-SC, CMUCA
	W	A	µF	max. number of lamps per current path at 230 V, 50 Hz			
Metal halide lamps without compensation e.g. HQI, HPI	35	0.53	-	28	57	-	-
	70	1	-	15	30	-	-
	150	1.8	-	8	17	-	-
	250	3	-	5	10	-	-
	400	3.5	-	4	8	-	-
	1000	9.5	-	1	3	-	-
	2000	16.5	-	-	2	-	-
400 V per pole	2000	10.5	-	-	2	-	-
	3500	18	-	-	1	-	-
Metal halide lamps with electronic ballast (50-125 xI <sub>n</sub> ) HQI	20	0.1	i	9	18	20	-
	35	0.2	i	6	11	13	-
	70	0.36	i	5	12	12	-
	150	0.7	i	4	10	10	-
Metal halide lamps with compensation, with parallel compensation e.g. HQI, HPI	35	0.25	6	21	42	58	-
	70	0.45	12	11	21	29	-
	150	0.75	20	7	13	18	-
	250	1.5	33	4	9	11	-
	400	2.1	35	4	9	10	-
	1000	5.8	95	1	3	4	-
	2000	11.5	148	-	2	2	-
400 V per pole	2000	6.6	58	-	3	4	-
	3500	11.6	100	-	2	3	-
Transformers for low-voltage halogen lamps	20	-	-	52	110	174	-
	50	-	-	24	50	80	-
	75	-	-	16	35	54	-
	100	-	-	12	27	43	-
	150	-	-	9	19	29	-
	200	-	-	5	14	23	-
	300	-	-	4	9	14	-

**Sodium Vapour Lamps**

For 200 W, 1200 mm high-pressure lamps and low-pressure lamps, reactance coils are used as ballast. For smaller lamps, stray field transformers can be used as ballast. Take into account, the long starting period.

**Low pressure lamps:**

Without compens.: Making current  $1 \times X_{l_e}$ ,  $\cos\varphi$  0.3; starting time 5 ... 10min  
Decisive for selection of device: 60% Constant current  
 $I = I_{eAC1} \times 0.6$

With compensation: Making current  $20 \times X_{l_e}$ ,  $\cos\varphi$  0.45; starting time 5 ... 10min  
(at  $1.6 \times I_n$ ),  $I = I_{peak}/200$

**High pressure lamps:**

Without compens.: Making current  $1.4 \times X_{l_e}$ ,  $\cos\varphi$  0.5; starting time 5 ... 10min  
Decisive for selection of device: 60% Constant current  
 $I = I_{eAC1} \times 0.6$

With compensation: Making current  $20 \times X_{l_e}$ ,  $\cos\varphi$  0.95; starting time 5 ... 10min  
(at  $1.6 \times I_n$ )

Lamp Types	Power	Current	Capacitor	Z-SCH/25/..	Z-SCH/40/..	Z-SCH/63/..	Z-SC,
	W	A	µF	CMUC.../25/			CMUCA
	max. number of lamps per current path at 230 V, 50 Hz						
Sodium vapour lamps low-pressure without compensation	35	1.5	-	9	22	30	-
	55	1.5	-	9	22	30	-
	90	2.4	-	6	13	19	-
	135	3.3	-	4	10	14	-
	150	3.3	-	4	10	14	-
	180	3.3	-	4	10	14	-
	200	3.3	-	4	10	14	-
Sodium vapour lamps low-pressure with compensation, with parallel compensation	35	0.31	20	6	15	18	-
	55	0.42	20	6	15	18	-
	90	0.63	30	4	10	12	-
	135	0.94	45	3	7	8	-
	150	1	40	3	8	9	-
	180	1.16	40	3	8	9	-
	200	1.32	30	-	10	12	-
Sodium vapour lamps high-pressure without compensation	150	1.8	-	8	15	22	-
	250	3	-	5	10	13	-
	330	3.7	-	4	8	10	-
	400	4.7	-	3	6	8	-
	1000	10.3	-	1	3	4	-
Sodium vapour lamps high pressure with compensation, with parallel compensation	150	0.83	20	7	20	25	-
	250	1.5	33	4	12	15	-
	330	2	40	3	10	13	-
	400	2.4	48	2	8	12	-
	1000	6,3	106	1	4	6	-
Sodium vapour lamps high pressure with electronic ballast (50-125 $xI_n$ )	20	0.1	i	9	18	20	-
	35	0.2	i	6	11	13	-
	70	0.36	i	5	12	12	-
	150	0.7	i	4	10	10	-

Utilisation Categories of Contactors

Type of current	Utilisation category	Typical Applications  I = Making current, I <sub>c</sub> = Breaking current, I <sub>e</sub> = Rated operational current, U = Voltage, U <sub>e</sub> = Rated operational voltage, U <sub>r</sub> = Recovery voltage	Verification of electrical service life							Verification of switching capacity						
			Switching on				Switching off			Switching on				Switching off		
			I <sub>e</sub> A	I A	U U <sub>e</sub>	cosφ	I <sub>c</sub> A	U <sub>r</sub> U <sub>e</sub>	cosφ	I <sub>e</sub> A	I A	U U <sub>e</sub>	cosφ	I <sub>c</sub> A	U <sub>r</sub> U <sub>e</sub>	cosφ
AC	AC-1	Non-inductive or slightly inductive load Resistance furnaces	all values	1	1	0.95	1	1	0.95	all values	1.5	1.05	0.8	1.5	1.05	0.8
	AC-2	Slip ring motors: starting, switching off	all values	2.5	1	0.65	2.5	1	0.65	all values	4	1.05	0.65	4	1.05	0.8
	AC-3	Squirrel cage motors: starting, switching off (running motors <sup>4)</sup> )	I <sub>e</sub> ≤ 17 I <sub>e</sub> > 17	6 6	1 1	0.65 0.35	1 1	0.17 0.17	0.65 0.35	I <sub>e</sub> ≤ 100 I <sub>e</sub> > 100	10 8	1.05 1.05	0.45 0.35	8 6	1.05 1.05	0.45 0.35
	AC-4	Squirrel cage motors: starting, plugging reversing, inching	I <sub>e</sub> ≤ 17 I <sub>e</sub> > 17	6 6	1 1	0.65 0.35	6 6	1 1	0.65 0.35	I <sub>e</sub> ≤ 100 I <sub>e</sub> > 100	12 10	1.05 1.05	0.45 0.35	10 8	1.05 1.05	0.45 0.35
	AC-5	Switching of electric discharge lamp controls									3.0	1.05	0.45	3.0	1.05	0.45
	AC-5b	Switching of incandescent lamps									1.5 <sup>2)</sup>	1.05 <sup>2)</sup>		1.05 <sup>2)</sup>	1.05 <sup>2)</sup>	
	AC-6a <sup>3)</sup>	Switching of transformers														
	AC-6b <sup>3)</sup>	Switching of capacitor banks														
	AC-7a	Slightly inductive loads in household appliances and similar applications	according to manufacturer specifications								1.5	1.05	0.8	1.5	1.05	0.8
	AC-7b	Motor loads for household appliances									8,0	1.05 <sup>1)</sup>		8,0	1.05 <sup>1)</sup>	
	AC-8a	Switching of hermetically enclosed refrigerant compressor motors with manual reset of overload releases <sup>5)</sup>									6,0	1.05 <sup>1)</sup>		6,0	1.05 <sup>1)</sup>	
AC-8b	Switching of hermetically enclosed refrigerant compressor motors with automatic reset of overload releases <sup>5)</sup>									6,0	1.05 <sup>1)</sup>		6,0	1.05 <sup>1)</sup>		
DC	DC-1	Non-inductive or slightly inductive load, Resistance furnaces	all values	1	1	1	1	1	1	all values	1.5	1.05	1	1.5	1.05	1
	DC-3	Shunt motors: starting, plugging, reversing, inching, dynamic braking	all values	2.5	1	2	2.5	1	2	all values	4	1.05	2.5	4	1.05	2.5
	DC-5	Series motors: starting, plugging, reversing, inching, dynamic braking	all values	2	1	7.5	2.5	1	7.5	all values	4	1.05	2.5	4	1.05	2.5
DC-6	Switching of incandescent lamps									1.5 <sup>2)</sup>	1.05 <sup>2)</sup>		1.5 <sup>2)</sup>	1.05 <sup>2)</sup>		

acc. to IEC 947-4-1, EN 60 947 VDE 0660 Part 102

<sup>1)</sup> cosφ = 0.45 for I<sub>e</sub> ≤ 100 A; cosφ = 0.35 for I<sub>e</sub> > 100 A.

<sup>2)</sup> The tests must be carried out with an incandescent lamp load connected.

<sup>3)</sup> In this case, the test data must be derived from the test values for AC-3 or AC-4 according to a special table.

<sup>4)</sup> Devices for utilisation category AC-3 may be used for occasional inching or plugging during a limited period, such as for setting up a machine. However, during this limited period of time, the number of operations must not exceed five per minute or ten in a ten minute period.

<sup>5)</sup> Hermetically enclosed refrigerant compressor motor means a combination of a compressor and a motor both of which are housed in the same enclosure with no external shaft or shaft seals, the motor running in the refrigerant.

#### Utilisation Categories of Auxiliary Switches

Type of current	Utilisation category	Typical Applications  I = Making current, I <sub>c</sub> = Breaking current, I <sub>e</sub> = Rated operational current, U = Voltage, U <sub>e</sub> = Rated operational voltage, U <sub>r</sub> = Recovery voltage, t <sub>0.95</sub> = the time in ms until 95% of the stationary current has been reached, P = U <sub>e</sub> x I <sub>e</sub> = Rated power in Watts	Normal conditions of use						Divergent conditions of use					
			Switching on			Switching off			Switching on			Switching off		
			I	U	cosφ	I <sub>c</sub>	U <sub>r</sub>	cosφ	I	U	cosφ	I <sub>c</sub>	U <sub>r</sub>	cosφ
			I <sub>e</sub>	U <sub>e</sub>		I <sub>e</sub>	U <sub>e</sub>		I <sub>e</sub>	U <sub>e</sub>		I <sub>e</sub>	U <sub>e</sub>	
AC	AC-12	Control of resistive and solid state loads in optocoupler input circuits	1	1	0.9	1	1	0.9	-	-	-	-	-	-
	AC-13	Control of solid state loads with transformer-isolation	2	1	0.65	1	1	0.65	10	1.1	0.65	1.1	1.1	0.65
	AC-14	Control of small electromagnetic loads (max. 72 VA)	6	1	0.3	1	1	0.3	6	1.1	0.7	6	1.1	0.7
	AC-15	Control of electromagnetic loads (above 72 VA)	10	1	0.3	1	1	0.3	10	1.1	0.3	10	1.1	0.3
			I	U	t <sub>0.95</sub>	I <sub>c</sub>	U <sub>r</sub>	t <sub>0.95</sub>	I	U	t <sub>0.95</sub>	I <sub>c</sub>	U <sub>r</sub>	t <sub>0.95</sub>
			I <sub>e</sub>	U <sub>e</sub>		I <sub>e</sub>	U <sub>e</sub>		I <sub>e</sub>	U <sub>e</sub>		I <sub>e</sub>	U <sub>e</sub>	
DC	DC-12	Control of resistive and solid state loads in optocoupler input circuits	1	1	1 ms	1	1	1 ms	-	-	-	-	-	-
	DC-13	Control of electromagnets	1	1	6xP <sup>1)</sup>	1	1	6xP <sup>1)</sup>	1.1	1.1	6xP <sup>1)</sup>	1.1	1.1	6xP <sup>1)</sup>
	DC-14	Control of electromagnetic loads with economy resistors in the circuit	10	1	15 ms	1	1	15 ms	10	1.1	15 ms	10	1.1	15 ms

acc. to IEC 947-4-1, EN 60 947 VDE 0660 Part 102

<sup>1)</sup> The value „6xP“ is the result of an empirical relationship which is found to represent most direct current magnetic loads up to an upper limit of P = 50W with 6 [ms]/[W] = 200 [ms]. Loads with a rated power above 50 W are composed of small loads located parallel to each other. Therefore, 300 ms is an upper limit independent of the power rating.

Control Voltage	Function	MU	Type Designation	Article No.	Units per package
-----------------	----------	----	------------------	-------------	-------------------

**Impulse Relays Z-S**

• 16 A 250 VAC

SG59611



Z-S230/SO

240 V 50Hz	1NO	1	Z-S240/S	265261	2 / 120
240 V 50Hz	2NO	1	Z-S240/SS	265269	2 / 120
240 V 50Hz	1NO+1NC	1	Z-S240/SO	265282	2 / 120
240 V 50Hz	2NO+2NC	2	Z-S240/2S20	265304	1 / 60
240 V 50Hz	1CO	1	Z-S240/W	265289	2 / 120
240 V 50Hz	2CO	2	Z-S240/WW	265311	1 / 60
240 V 60Hz	2NO	1	Z-S241/SS	265268	2 / 120
230 V 50Hz	1NO	1	Z-S230/S	265262	2 / 120
230 V 50Hz	2NO	1	Z-S230/SS	265271	2 / 120
230 V 50Hz	4NO	2	Z-S230/4S	270335	1 / 60
230 V 50Hz	1NO+1NC	1	Z-S230/SO	265283	2 / 120
230 V 50Hz	2NO+2NC	2	Z-S230/2S20	265305	1 / 60
230 V 50Hz	1CO	1	Z-S230/W	265290	2 / 120
230 V 50Hz	2CO	2	Z-S230/WW	265312	1 / 60
230 V 60Hz	2NO	1	Z-S231/SS	265270	2 / 120
110 V 50Hz	1NO	1	Z-S110/S	265263	2 / 120
110 V 50Hz	2NO	1	Z-S110/SS	265273	2 / 120
110 V 50Hz	1NO+1NC	1	Z-S110/SO	265284	2 / 120
110 V 50Hz	2NO+2NC	2	Z-S110/2S20	265306	1 / 60
110 V 50Hz	1CO	1	Z-S110/W	265291	2 / 120
110 V 50Hz	2CO	2	Z-S110/WW	265313	1 / 60
110 V 60Hz	2NO	1	Z-S111/SS	265272	2 / 120
110 V DC	2NO	1	Z-S109/SS	265274	2 / 120
110 V DC	1CO	1	Z-S109/W	265292	2 / 120
110 V DC	2CO	2	Z-S109/WW	265314	1 / 60
48VAC/24VDC*)	1NO	1	Z-S48/S	265534	2 / 120
48VAC/24VDC*)	2NO	1	Z-S48/SS	265536	2 / 120
48VAC/24VDC*)	4NO	2	Z-S48/4S	100665	1 / 60
48VAC/24VDC*)	1NO+1NC	1	Z-S48/SO	265538	2 / 120
48VAC/24VDC*)	2NO+2NC	2	Z-S48/2S20	265540	1 / 60
48VAC/24VDC*)	1CO	1	Z-S48/W	265544	2 / 120
48VAC/24VDC*)	2CO	2	Z-S48/WW	265542	1 / 60
24VAC/12VDC*)	1NO	1	Z-S24/S	265535	2 / 120
24VAC/12VDC*)	2NO	1	Z-S24/SS	265537	2 / 120
24VAC/12VDC*)	1NO+1NC	1	Z-S24/SO	265539	2 / 120
24VAC/12VDC*)	2NO+2NC	2	Z-S24/2S20	265541	1 / 60
24VAC/12VDC*)	1CO	1	Z-S24/W	265545	2 / 120
24VAC/12VDC*)	2CO	2	Z-S24/WW	265543	1 / 60
24 V 60Hz	2NO	1	Z-S25/SS	265276	2 / 120
12 V 50Hz	1NO	1	Z-S12/S	265266	2 / 120
12 V 50Hz	2NO	1	Z-S12/SS	265278	2 / 120
12 V 50Hz	1NO+1NC	1	Z-S12/SO	265287	2 / 120
12 V 50Hz	2NO+2NC	2	Z-S12/2S20	265309	1 / 60
12 V 50Hz	1CO	1	Z-S12/W	265296	2 / 120
12 V 50Hz	2CO	2	Z-S12/WW	265317	1 / 60
8 V 50Hz	1NO	1	Z-S8/S	265267	2 / 120
8 V 50Hz	2NO	1	Z-S8/SS	265280	2 / 120
8 V 50Hz	1NO+1NC	1	Z-S8/SO	265288	2 / 120
8 V 50Hz	2NO+2NC	2	Z-S8/2S20	265310	1 / 60
8 V 50Hz	1CO	1	Z-S8/W	265297	2 / 120
8 V 50Hz	2CO	2	Z-S8/WW	265318	1 / 60
8 V DC	2NO	1	Z-S7/SS	265281	2 / 120
8 V DC	1CO	1	Z-S7/W	265298	2 / 120
8 V DC	2CO	2	Z-S7/WW	265319	1 / 60

\*) Doppelspannung AC/DC



### Impulse Relays Z-S

Control Voltage	Function	MU	Type Designation	Article No.	Units per package
-----------------	----------	----	------------------	-------------	-------------------

#### Impulse Relays with central control Z-SC

SG69011



Z-SC230/S

240 V AC 50/60Hz	3NO	2	Z-SC240/3S	265320	1 / 60
240 V AC 50/60Hz	1NO+1CO	2	Z-SC240/1S1W	265323	1 / 60
240 V AC 50/60Hz	2NO+1NC	2	Z-SC240/2S1O	265326	1 / 60
230 V AC 50/60Hz	1NO	1	Z-SC230/S	265299	2 / 120
230 V AC 50/60Hz	3NO	2	Z-SC230/3S	265321	1 / 60
230 V AC 50/60Hz	1NO+1CO	2	Z-SC230/1S1W	265324	1 / 60
230 V AC 50/60Hz	2NO+1NC	2	Z-SC230/2S1O	265327	1 / 60
24 V AC 50/60Hz	1NO	1	Z-SC24/S	265300	2 / 120

#### Impulse Relays with switchable LED Z-SB

SG69111



Z-SB230/SS

230 V 50Hz	2NO	1	Z-SB230/SS	265301	2 / 120
24 V 50Hz	2NO	1	Z-SB24/SS	265302	2 / 120
24 V DC	2NO	1	Z-SB23/SS	265303	2 / 120

Description	MU	Type Designation	Article No.	Units per package
-------------	----	------------------	-------------	-------------------

#### Accessories for Z-S./.

SG59011



Z-S/KO

Compensator	1	Z-S/KO	270588	2 / 120
Group block	1	Z-SC/GP	270587	2 / 120

#### Busbar

wa\_sg02512



Z-EK/25

1pole angulated grey 10 mm <sup>2</sup>		Z-SV-10/1P-F/13	264918	10
1pole angulated blue 10 mm <sup>2</sup>		Z-SV-10/N-F/13	264919	10
1pole angulated grey 16 mm <sup>2</sup>		Z-SV-16/1P-1MU/F	269523	25
1pole angulated blue 16 mm <sup>2</sup>		Z-SV-16/N-1MU/F	269524	25
Extension terminal 25 mm <sup>2</sup> long, straight		Z-EK/25	264935	10 / 600
Extension terminal 25 mm <sup>2</sup> short, straight		Z-EK/25/K	269525	10 / 600
Extension terminal 25 mm <sup>2</sup> long, crosswise		Z-EK/25/QL	264937	10 / 600
Extension terminal 25 mm <sup>2</sup> short, crosswise		Z-EK/25/Q	264936	10 / 600

**Description Impulse Relays Z-S**

- Impulse relays according to EN/IEC 60669 for switching electrical consumers in impulse operation.
- Shape and terminal compatible with the installation relay range
- Manual operation for testing purposes is possible
- Separately switchable LED (Z-SB../SS) for signalling purposes
- Glow lamps of illuminated pushbuttons connected parallel produce reactive currents which may be compensated by a capacitor block in order to prevent excessive heating of coils in case of high numbers of glow lamps.
- Glow lamps parallel to control keys according to table
- Main contacts can be connected to standard pin busbar

**Security:**

- Optional optical operating status display by means of LED
- Switching position indicated on the front side by manual operating key
- All terminals - coil and contacts - equipped with guide for secure terminal connection. Misplacement of wires impossible.
- Made of hardly flammable materials and plastics free from chlorine and halogens.
- Finger and hand touch safe according to VBG4

**Advantages:**

- Available in two versions (Z-S., Z-SB.)
- Low switching noise
- Easy to connect thanks to large terminals which are supplied open
- Simple snap-on fastening on 35 mm DIN rail
- High degree of flexibility thanks to a variety of contact configurations
- Easy access for coil connection

**Accessories:**

Capacitor block	Z-S/KO	270588
-----------------	--------	--------

**Connection diagram**

**1MU Z-S./.**

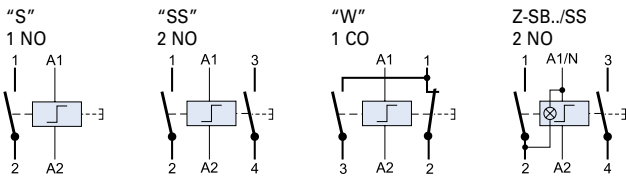

**2MU Z-S./.**

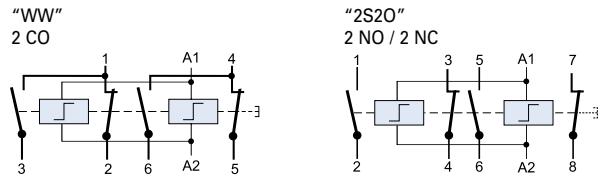

**Packing density**

Spacers obligatory! (Z-DST)

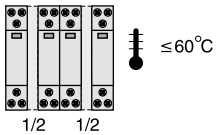

**Dimensions (mm)**

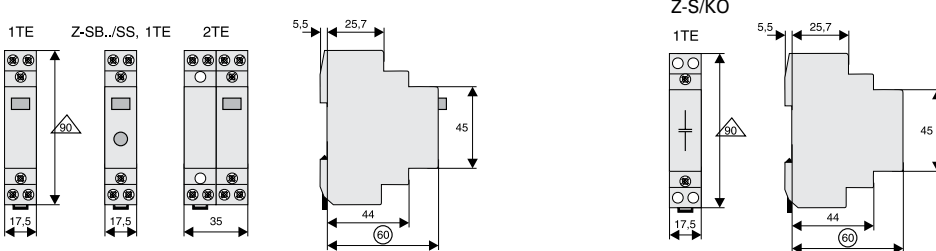

## Technical Data

		Z-S
<b>Electrical</b>		
Rated current (IEC/EN 60669-2-2) 250 V AC		16 A
Number of poles		1 to 4
Main contacts		
NO/NC		1/2 (1MU), 3/4 (2MU)
CO		1 (1MU), 2 (2MU)
<b>Control circuit</b>		
Rated control feed voltage	$U_s$	
AC		8, 12, 24, 48, 230 V
DC		8, 12, 24, 110 V
Alternative control voltages, frequencies, and contact arrangements upon enquiry		
Rated frequency		50 Hz
Operating range		0.9-1.1 x $U_s$
Pickup power of coils		12 VA / 7 W typ.
Max. number of parallel pushbutton units		unlimited
Max. number of parallel illuminated pushbutton units 230 V 0.6 mA typ.		
without compensation		8 units (1MU), 15 units (2MU)
with compensation 1 x Z-SC/KO (Z-S/KO)		23 units (1MU), –
with compensation 2 x Z-SC/KO (Z-S/KO)		46 units (1MU), 43 units (2MU)
Minimum command duration		> 200 ms
Operating noise		no humming
Rated peak withstand voltage (1.2/50 $\mu$ s)	$U_{imp}$	2 kV
Duty max. (only in case of breakdown of control system)		1 h, 100% with spacer
<b>Load Circuit</b>		
Rated operational voltage	$U_e$	
1p, 2p		250 VAC
3p, 4p		240/415 VAC
Minimum operational voltage	$U_{min}$	24 V AC/DC ( $U_s$ 8-110 V)
Rated insulation voltage	$U_i$	500 V
Rated peak withstand voltage (1.2/50 $\mu$ s)	$U_{imp}$	4 kV
Conventional thermal current	$I_{th}$	16 A AC
Rated operational current	$I_e$	16 A AC
Rated constant current	$I_u$	16 A AC
Rated current DC	$I_e$	
24 V		16 A
48 V		12.5 A
230 V		1 A
Conditional rated short circuit current	$I_g$	10 kA (with 20 A gL/gG)
Duration of bouncing		< 10 ms (typ. < 5 ms)
Endurance		
electrical components		$\geq 40 \times 10^3$ switching operations
mechanical components		$\geq 1 \times 10^6$ switching operations
<b>Mechanical</b>		
Frame size		45 mm
Device height		90 mm
Device width		17.5 mm pro MU
Mounting		quick fastening on DIN rail IEC/EN 60715
Degree of protection, built-in		IP20
Mounting position		as required
Upper and lower terminals		lift terminals (captive)
Terminal capacity		
Contact and coil		0.5 - 10 mm <sup>2</sup> one- or more wire 0.5 - 6 mm <sup>2</sup> fine wires with wire end sleeve
Temperature range		-20 to +45 °C
Total contact gap		> 5mm / independent contacts
Contact material		does not contain cadmium
<b>Accessories</b>		
Capacitor block		1.5 $\mu$ F, 240 V AC

Impulse Relays with switchable LED

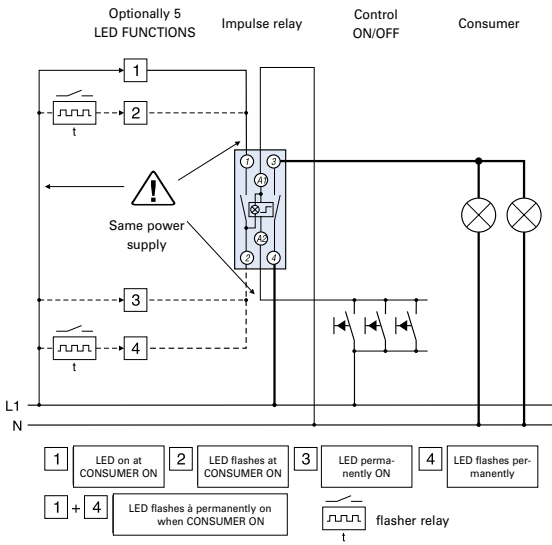

24 V AC and DC Application

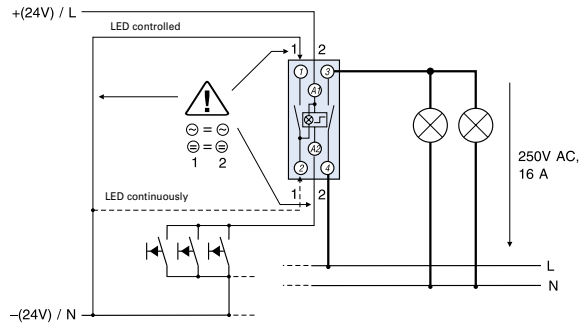

#### Description Impulse Relays Z-SC with Central Control

- Impulse relay according to EN/IEC 60669 for switching electrical consumers in impulse operation.
- Local and central control, capable of switching 2-stage groups
- Shape and terminal compatible with the installation relay range
- Manual operation for testing purposes is possible
- Glow lamps of illuminated pushbuttons connected parallel produce reactive currents which may be compensated by a capacitor block in order to prevent excessive heating of coils in case of high numbers of glow lamps.
- Glow lamps parallel to control keys according to table
- Main contacts can be connected to standard busbar

#### Security:

- Switching position indicated on the front side by manual operating key
- All terminals - coil and contacts - equipped with guide for secure terminal connection. Misplacement of wires impossible.
- Made of hardly flammable materials and plastics free from chlorine and halogens.
- Finger and hand touch safe according to VBG4.

#### Advantages:

- Low switching noise
- Easy to connect thanks to large terminals which are supplied open
- Simple snap-on fastening on 35 mm DIN rail
- High degree of flexibility thanks to a variety of contact configurations
- Easy access for coil connection

#### Connection diagram

##### 1MU Z-SC./S

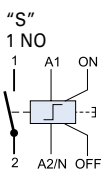

##### 2MU Z-SC./.

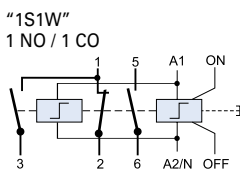

##### 2MU Z-SC./.

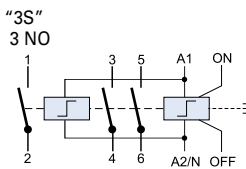
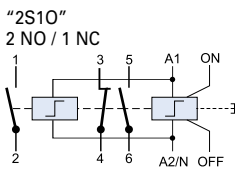

#### Packing density

Spacers obligatory! (Z-DST)

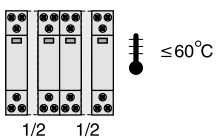

#### Dimensions (mm)

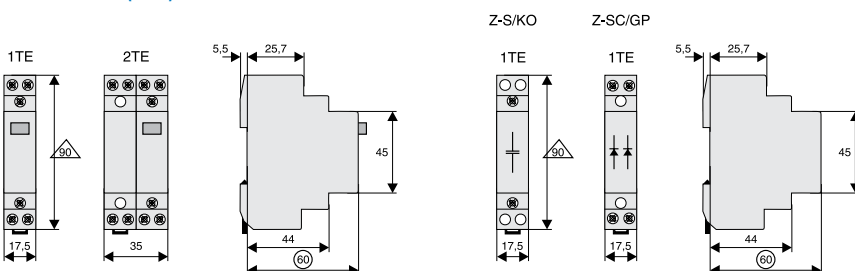

## Technical Data

		Z-SC
<b>Electrical</b>		
Rated current (IEC/EN 60669-2-2) 250 V AC		16 A
Number of poles		1 to 3
Main contacts		
NO		1 (1MU), 3 (2MU)
NO/NC		2+1 (2MU)
CO/NO		1 (2MU)
<b>Control circuit</b>		
Rated control feed voltage	$U_s$	
AC		12, 24, 230, 240 V
Alternative control voltages, frequencies, and contact arrangements upon enquiry		
Rated frequency		50 Hz; 50-60 Hz 240 V
Operating range		$0.9-1.1 \times U_s$
Maximum power of coils, pick-up		
$U_s = 24$ V		25 VA (15W)
$U_s = 230$ V		32 VA (19W)
Max. number of parallel pushbutton units		unlimited
Max. number of parallel illuminated pushbutton units 230 V 0.6 mA typ.		
without compensation		4 units (1MU, 2MU)
with compensation 1 x Z-SC/KO (Z-S/KO)		19 units (1MU), 9 units (2MU)
with compensation 2 x Z-SC/KO (Z-S/KO)		30 units (1MU), 18 units (2MU)
Minimum command duration		> 200 ms
Operating noise		no humming
Rated peak withstand voltage (1.2/50 $\mu$ s)	$U_{imp}$	2 kV
Duty max. (only in case of breakdown of control system)		100% (1MU), <100% (2MU), 1h max. with spacer
<b>Load Circuit</b>		
Rated operational voltage	$U_e$	
1p, 2p		250 VAC
3p		240/415 VAC
Minimum operational voltage	$U_{min}$	24 V AC/DC ( $U_s$ 8-110 V)
Rated insulation voltage	$U_i$	500 V
Rated peak withstand voltage (1.2/50 $\mu$ s)	$U_{imp}$	4 kV
Conventional thermal current	$I_{th}$	16 A AC
Rated operational current	$I_e$	16 A AC
Rated constant current	$I_u$	16 A AC
Rated current DC	$I_e$	
24 V		16 A
48 V		12.5 A
230 V		1 A
Conditional rated short circuit current	$I_q$	10 kA (with 20 A gL/gG)
Duration of bouncing		< 10 ms (typ. < 5 ms)
Endurance		
electrical components		$\geq 40 \times 10^3$ switching operations
mechanical components		$\geq 1 \times 10^6$ switching operations
<b>Mechanical</b>		
Frame size		45 mm
Device height		90 mm
Device width		17.5 mm (1MU), 35 mm (2MU)
Mounting		quick fastening on DIN rail IEC/EN 60715
Degree of protection, built-in		IP20
Mounting position		as required
Upper and lower terminals		lift terminals (captive)
Terminal capacity		
Contact and coil		0.5 - 10 mm <sup>2</sup> one- or more wire 0.5 - 6 mm <sup>2</sup> fine wires with wire end sleeve
Temperature range		-20 to +45 °C
Total contact gap		> 5mm / independent contacts
Contact material		does not contain cadmium
<b>Accessories</b>		
Capacitor block		1.5 $\mu$ F, 240 V AC
Group block		240 V AC

#### Block Diagram for Central, Group, and Local Control

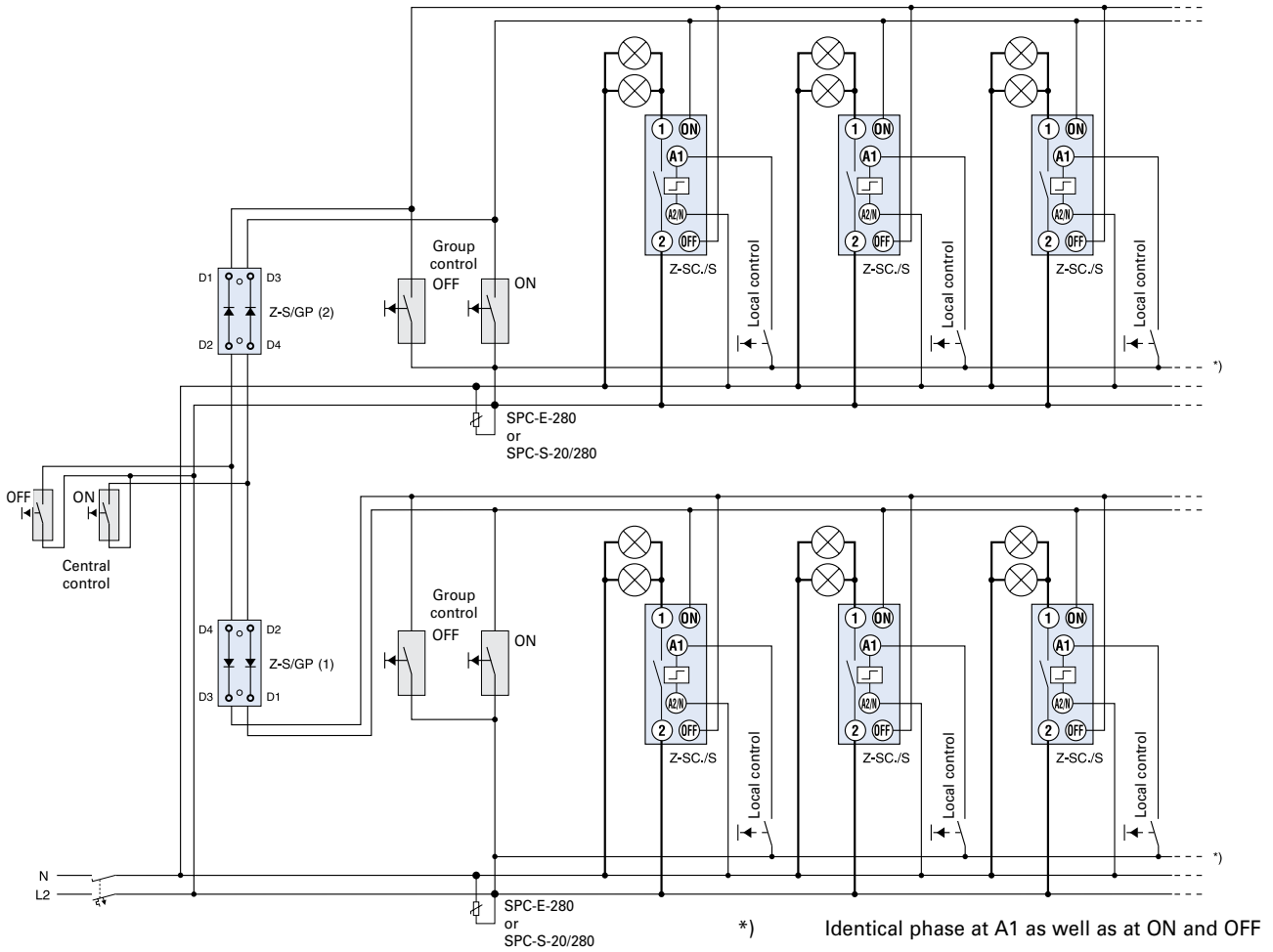

#### Compensation by means of Capacitor Block

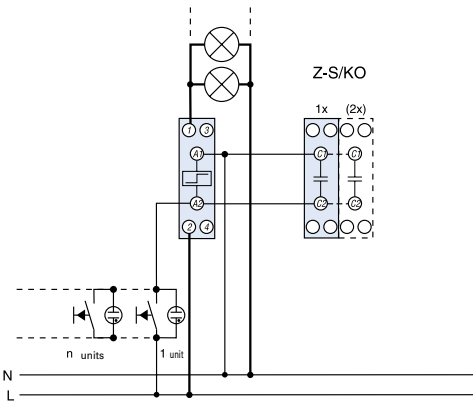

**Utilisation categories (according to IEC/EN 60947-4-1)**

**Utilisation categories 1MU (1S, 2S, 1S+10, 1W), 2MU (2S+20, 2W, 3S+10) Z-S, Z-ZC, Z-SB**

AC-1 $\text{---}\triangle\triangle\text{---}$	Rated operational voltage	$U_e$	250 V AC
	Rated operational current	$I_e$	16 A AC
	Rated operational power AC-1		3200 W ( $\cos\varphi = 0.8$ ), 4000 VA
	Make-/break-current AC-1	$I_c$	24 A AC
AC-3 $\text{---}\textcircled{S}\text{---}$	Rated operational voltage	$U_e$	250 V AC
	Rated operational current	$I_e$	8 A AC
	Rated operational power AC-3		900 W ( $\cos\varphi = 0.45$ ), 2000 VA
	Make-/break-current AC-3	$I_c$	80 A AC
AC-5a $\text{---}\otimes\text{---}$	Rated operational voltage	$U_e$	250 V AC
	Rated operational current	$I_e$	10 A AC
	Rated operational power AC-5a		1125 W ( $\cos\varphi = 0.45$ ), 2500 VA
	Make-/break-current AC-5a	$I_c$	30 A AC
AC-5b $\text{---}\otimes\text{---}$	Rated operational voltage	$U_e$	230 V AC
	Rated operational current	$I_e$	8.8 A AC
	Rated operational power AC-5b		2024 W
	Make-/break-current AC-5b	$I_c$	13.2 A AC
AC-7a (according to EN 61095) $\text{---}\blacksquare\text{---}$	Rated operational voltage	$U_e$	250 V AC
	Rated operational current	$I_e$	16 A AC
	Rated operational power AC-7a		3200 W ( $\cos\varphi = 0.8$ ), 4000 VA
	Make-/break-current AC-7a	$I_c$	24 A AC

**Utilisation categories 2MU (3S, 4S)**

AC-1 $\text{---}\triangle\triangle\text{---}$	Rated operational voltage	$U_e$	240/415 V AC
	Rated operational current	$I_e$	16 A AC
	Rated operational power AC-1		3200 W ( $\cos\varphi = 0.8$ ), 4000 VA
	Make-/break-current AC-1	$I_c$	24 A AC
AC-3 $\text{---}\textcircled{S}\text{---}$	Rated operational voltage	$U_e$	240/415 V AC
	Rated operational current	$I_e$	8 A AC
	Rated operational power AC-3		900 W ( $\cos\varphi = 0.45$ ), 2000 VA
	Make-/break-current AC-3	$I_c$	80 A AC / 64 A AC
AC-5a $\text{---}\otimes\text{---}$	Rated operational voltage	$U_e$	240/415 V AC
	Rated operational current	$I_e$	10 A AC
	Rated operational power AC-5a		1125 W ( $\cos\varphi = 0.45$ ), 2500 VA
	Make-/break-current AC-5a	$I_c$	30 A AC
AC-5b $\text{---}\otimes\text{---}$	Rated operational voltage	$U_e$	230/400 V AC
	Rated operational current	$I_e$	8.8 A AC
	Rated operational power AC-5b		2024 W
	Make-/break-current AC-5b	$I_c$	13.2 A AC
AC-7a (according to EN 61095) $\text{---}\blacksquare\text{---}$	Rated operational voltage	$U_e$	240/415 V AC
	Rated operational current	$I_e$	16 A AC
	Rated operational power AC-7a		3200 W ( $\cos\varphi = 0.8$ ), 4000 VA
	Make-/break-current AC-7a	$I_c$	24 A AC
AC-7b (according to EN 61095) $\text{---}\textcircled{S}\text{---}$	Rated operational voltage	$U_e$	240/415 V AC
	Rated operational current	$I_e$	10 A AC
	Rated operational power AC-7b		1125 W ( $\cos\varphi = 0.8$ ), 2500 VA
	Make-/break-current AC-7b	$I_c$	30 A AC



# 1.52

## Controlling & Switching

xPole

Impulse Relays Z-S, Z-SC, Z-SB

Lamp Types	Power W	Current A	Capacitor µF	Z-S, Z-ZC, Z-SB max. number of lamps per current path at 230 V, 50 Hz
Incandescent Lamps	60	0.27		33
Low-voltage halogen lamps (12 or 24 V) with transformer / electronic transformer	20	0.09	-	55
	50	0.22	-	22
	75	0.33	-	14
	100	0.43	-	11
	150	0.65	-	7
	200	0.87	-	5
	300	1.3	-	3
Fluorescent tubes without compensation or with series compensation	11	0.16	1.3	62
	18	0.37	2.7	27
	24	0.35	2.5	27
	36	0.43	3.4	24
	58	0.67	5.3	15
	65	0.67	5.3	14
	85	0.8	5.3	12
Fluorescent tubes lead-lag circuit	11	0.07	-	2 x 71
	18	0.11	-	2 x 45
	24	0.14	-	2 x 35
	36	0.22	-	2 x 22
	58	0.35	-	2 x 14
	65	0.35	-	2 x 14
	85	0.47	-	2 x 10
Fluorescent tubes with parallel compensa- tion	11	0.16	3.0	34
	18	0.37	4.0	26
	24	0.35	4.0	26
	36	0.43	4.0	26
	58	0.67	7.0	14
	65	0.67	7.0	14
	85	0.8	8.0	13
Fluorescent tubes with electronic ballast	18	0.09	-	32
	36	0.16	-	16
	58	0.25	-	12
	2 x 18	0.17	-	16
	2 x 36	0.32	-	8
	2 x 58	0.49	-	6

Staircase Switch with switch-off warning and stop function TL

Function	Type Designation	Article No.	Units per package
<b>Staircase Switch with switch-off warning and stop function TL</b>			
Staircase switch with switchoff warning and stop function	TLE	101064	2 / 120
Staircase switch as TLE, with additional control input for central control, zero-voltage proof	TLK	101066	2 / 120

SG07312



Description Staircase Switch with switch-off warning and stop function TL

- Automatic electronic staircase switch
- Switch-off warning can be switched off (type TLK)
- Subsequent switching is possible, programmable long-time function
- Power saving function, low switching noise
- Automatic 3-/4 wire circuit recognition
- Zero voltage safety thanks to memory function (type TLK)
- Central control function (type TLK)
- External voltage control input (type TLK)

Connection diagram

e.g. 3 wire circuit TLE

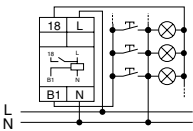

e.g. 4 wire circuit with attic lighting TLK

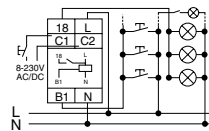

Dimensions (mm)

TLE: 87mm height, 17.5mm width. TLK: 87mm height, 17.5mm width. Mounting hole spacing: 45mm, 60mm.

TLE terminals: 0.5, 15, 10, 5, 5. TLK terminals: 3, 6, 9, 15, 10, 5, 5.

**Modes**

- ⌚ Automatic timing
- ⌚ Automatic timing with switch-off warning
- ☀ Permanent light
- ⬛ Off
- ⏏ Impulse relay
- ⏏ Impulse relay, zero-voltage proof

Power ratings: 2000 W, 1000 W, 500 W, max. 100 mA

Functional Description

Automatic timing ⌚ ⌚ :

After pushing the button the output relay closes (terminals L-18) and the set time starts to run. If the button is pushed again before the time  $t$  has lapsed the time re-starts from zero (subsequent switching function in accordance with EN 60669-2-3). Repeated quick pressing of the pushbutton („pumping”) leads to the addition of 2, 3 or more time intervals up to 60 min. Pushing the button once for a long time ( $> 2$  s) stops the running lighting period, and the relay switches off (power saving function). In the ⌚ function, the device generates short pulses (flickering) as a switch-off warning (according to DIN 18015-2), 15 s, 10 s, and 5 s prior to switching off.

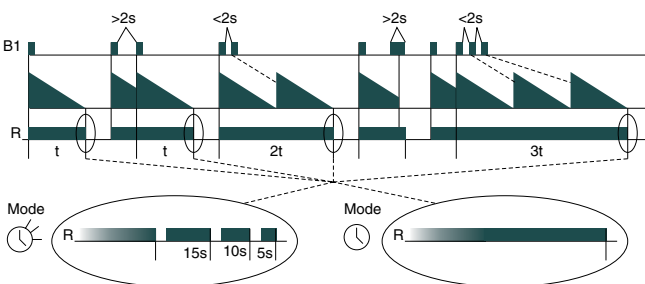

Impulse mode ⏏ ⏏ :

In the impulse mode each push of the button makes the output relay switch over. In the function ⏏ the output relay is always open after the feed voltage has been applied. In the function ⏏ the relay immediately picks up when the feed voltage is applied provided that it was closed prior to the power failure. By applying a short voltage pulse ( $< 2$  s) to the additional control input C1-C2 the relay R is switched on (central ON). A longer voltage pulse ( $> 2$  s) causes the relay R to switch off (central OFF).

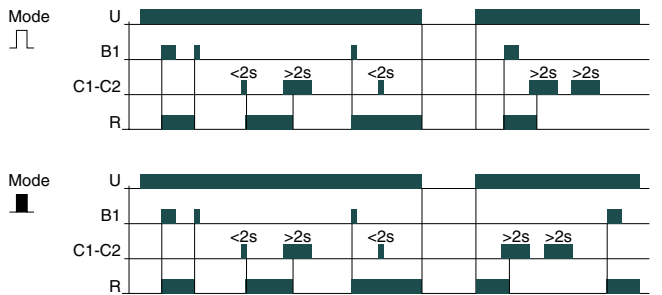

The additional control input permits activating the staircase switch e.g. from an intercom system by means of a voltage from 8 to 230 V AC/DC in the modes ⌚ and ⌚. This input channel permits starting the lighting time, as well as subsequent switching. Switching off (power saving function) and programming of longer lighting periods („pumping”) is not possible via this input channel.

**Technical Data**

	<b>TL</b>
<b>Electrical</b>	
Feed voltage	230 V AC
Rated voltage tolerance	-15%, +10%
Power consumption	6 VA (0.8 W)
Rated frequency	48-63 Hz
Duty	100%
Reset time	500 ms
Adjustment range	0.5 - 15 min.
Overvoltage category	III (in accordance with IEC 60664-1)
Rated surge voltage	4 kV
<b>Output</b>	
Switching contact	1 NO (Terminals L-18)
Rated voltage	250 VAC
Constant current	16 A
Switch on peak current (20 ms)	80 A
Breaking capacity AC	4000 VA / AC1, 384 W / DC
Maximum current	30 A / < 3s
Switching voltage	250 V AC1 / 24 V DC
Min. Breaking capacity DC	500 mW
Output indication	yellow LED (L1)
Mechanical endurance	30 x 10 <sup>6</sup> switching operations
Electrical endurance (AC1)	10 x 10 <sup>5</sup> switching operations 16 A / 250 V
<b>Control input B1</b>	
Connection (carrying voltage)	Pushbutton T-N (3-wire circuit) Pushbutton T-L (4-wire circuit)
Glow lamps parallel to control keys	max. 100 mA
Overload protection	electronic
<b>Control input</b>	
C1-C2 (Type TLK)	8-230 V AC/DC
<b>Mechanical</b>	
Frame size	45 mm
Device height	87 mm
Device width	17.5 mm (1MU)
Mounting	quick fastening on DIN rail IEC/EN 60715
Degree of protection / Pollution degree	IP20 / 2
Type of connection	lift terminals according to VBG 4 (PZ1 required)
Terminal capacity	1x 0.5-4 mm <sup>2</sup> , 2x 0.5-2.5 mm <sup>2</sup>
Tightening torque	max. 1 Nm
Temperature range	-25 to +55 °C
Operation position	as required

Function	Contactors	Type Designation	Article No.	Units per package
<b>Time-Lag Relay ZR</b>				
E, R	1CO	ZRER/W	110405	2 / 120
E, R, Ws, Wa, Es, Wu, Bp	1CO	ZRMF1/W	110406	2 / 120
E, R, Ws, Wa, Es, Wu, Bp	2CO	ZRMF2/WW	110408	1 / 60
lp, li	1CO	ZRTAK/W	110747	2 / 120

SG07412



ZRMF1/W

SG07912



ZRMF2/WW

**Description Time-Lag Relay ZR**

Functions

- **ZRER/W**
  - E ON delay
  - R OFF delay
- **ZRMF1/W, ZRMF2/WW**
  - E ON delay
  - R OFF delay
  - Ws Single shot leading edge with control input
  - Wa Single shot trailing edge with control input
  - Es ON delay with control input
  - Wu Single shot leading edge voltage controlled
  - Bp Flasher pause first
- **ZRTAK/W**
  - lp Asymmetric flasher pause first
  - li Asymmetric flasher pulse first (with bridge A1-B1)

Indicators

**ZRER/W, ZRMF1/W, ZRMF2/WW**

- Green LED U/t ON: indication of supply voltage
- Green LED U/t flashes: indication of time period
- Gelbe LED R ON/OFF: indication of output relay

**ZRTAK/W**

- Green LED U/t ON: indication of supply voltage
- Green LED U/t slow flashing: indication of time period t1
- Green LED U/t fast flashing: indication of time period t2
- Gelbe LED R ON/OFF: indication of output relay

**Time Ranges**

Absolute time range	Adjustment range	
1s	50ms	1s
10s	500ms	10s
1min	3s	1min
10min	30s	10min
1h	3min	1h
10h	30min	10h
100h	5h	100h

**Connection diagram**

Type ZRTAK/W

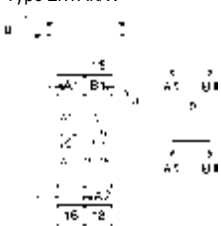

Type ZRER/W, ZRMF1/W

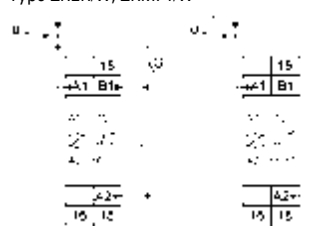

Type ZRMF2/WW

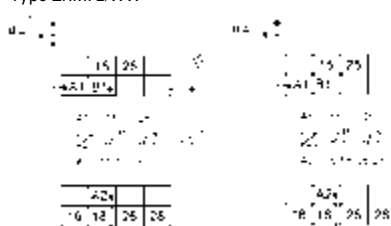

### Technical Data

<b>ZR</b>	
<b>Electrical</b>	
Standard according	EN 60669
Basic accuracy	±1% (of scale end value)
Setting accuracy	<5% (of scale end value)
Repeating accuracy:	<0.5% or ±5ms
Effect of voltage	–
Effect of temperature	≤0.01% / °C
<b>Input circuit</b>	
Feed voltage Terminals A1-A2	24 V to 240 V AC/DC, 24 V / -15% to 240 V / +10%
Rated frequency	48 to 63 Hz
Power consumption	
Type: .../W	4 VA (1.5 W)
Type: .../WW	6 VA (2 W)
Duty	100%
Reset time	100 ms
Residual ripple in case of DC	10%
Release voltage	>30% of min. feed voltage
<b>Output circuit</b>	
Breaking capacity	2000 VA (8 A / 250 V AC)
Fuse protection	8 A fast
Endurance	
electrical components at a resistive load of 1000 VA	2 x 10 <sup>5</sup> switching operations
mechanical components	20 x 10 <sup>6</sup> switching operations
Switching frequency	
at a resistive load of 100 VA	max. 60/min
at a resistive load of 1000 VA (in accordance with IEC 60947-5-1)	max. 6/min
Rated surge voltage	4 kV
Overvoltage category	III (in accordance with IEC 60664-1)
<b>Control contact</b>	
Input carrying potential loadable	Terminals A1-B1 yes
Maximum line length	10 m
Overload protection	electronic
Minimum control pulse length	
DC	50 ms
AC	100 ms
Trigger level (sensitivity)	automatic adaption to supply voltage
<b>Mechanical</b>	
Frame size	45 mm
Device height	87 mm
Device width	17.5 mm (/W) and 35 mm (/WW)
Degree of protection, built-in	IP40
Operation position	as required
Upper and lower terminals	lift terminals
Terminal protection	finger and hand touch safe according to DGUV VS3, EN 50274
Terminal capacity	1 x 0.5-2.5 mm <sup>2</sup> with/without multicore cable end 1 x 4 mm <sup>2</sup> without multicore cable end 2 x 0.5-1.5 mm <sup>2</sup> with/without multicore cable end 2 x 2.5 mm <sup>2</sup> flexible without multicore cable end
Tightening torque of terminal screws	max. 1 Nm
Permitted relative air humidity in accordance with IEC 60721-3-3 class 3K3	15 to 85%
Ambient temperature in accordance with IEC 60068-1	-25 to +55 °C
Storage and transport temperature	-25 to +70 °C
Pollution degree	2
when built in	3

### Dimensions (mm)

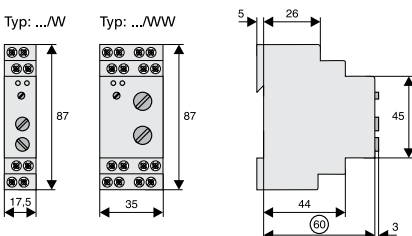

**Description of Functions**

• **ON delay (E)**

When the supply voltage U is applied, the set interval t begins (green LED U/t flashes). After the interval t has expired (green LED U/t illuminated) the output relay R switches into on-position (yellow LED illuminated) This status remains until the supply voltage is interrupted. If the supply voltage is interrupted before the expiry of the interval t, the interval already expired is erased and is restarted when the supply voltage is next applied.



• **OFF delay (R)**

The supply voltage U must be constantly applied to the device (green LED U/t illuminated) When the control contact S is closed, the output relay R switches into on-position (yellow LED illuminated). If the control contact is opened, the set interval t begins (green LED flashes) After the interval t has expired (green LED U/t illuminated) the output relay switches into off-position (yellow LED not illuminated) If the control contact is closed again before the interval t has expired, the interval already expired is erased and is restarted.

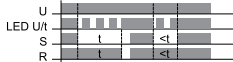

• **Single shot leading edge with control input (Ws)**

The supply voltage U must be constantly applied to the device (green LED U/t illuminated). When the control contact S is closed, the output relay R switches into on-position (green LED U/t illuminated) and the set interval t begins (green LED U/t flashes). After the interval t has expired (green LED U/t illuminated) the output relay switches into off-position (yellow LED not illuminated). During the interval, the control contact can be operated any number of times. A further cycle can only be started when the cycle run has been completed.

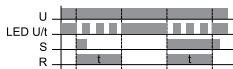

• **Single shot trailing edge with control input (Wa)**

The supply voltage U must be constantly applied to the device (green LED U/t illuminated). Closing the control contact S has no influence on the condition of the output R. When the control contact is opened, the output relay switches into on-position (yellow LED illuminated) and the set interval t begins (green LED U/t flashes). After the interval t has expired (green LED U/t illuminated), the output relay switches into off-position (yellow LED not illuminated). During the interval, the control contact can be operated any number of times. A further cycle can only be started when the cycle run has been completed.



• **ON delay with control input (Es)**

The supply voltage U must be constantly applied to the device (green LED U/t illuminated). When the control contact S is closed, the set interval t begins (green LED U/t flashes). After the interval t has expired (green LED U/t illuminated) the output relay R switches into on-position (yellow LED illuminated). This status remains until the control contact is opened again. If the control contact is opened before the interval t has expired, the interval already expired is erased and is restarted with the next cycle.

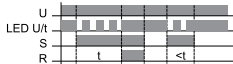

• **Single shot leading edge voltage controlled (Wu)**

When the supply voltage U is applied, the output relay R switches into on-position (yellow LED illuminated) and the set interval t begins (green LED U/t flashes). After the interval t has expired (green LED U/t illuminated) the output relay switches into off-position (yellow LED not illuminated). This status remains until the supply voltage is interrupted. If the supply voltage is interrupted before the interval t has expired. The output relay switches into off-position. The interval already is erased and is restarted when the supply voltage is next applied.



• **Flasher pause first (Bp)**

When the supply voltage U is applied, the set interval t begins (green LED U/t flashes). After the interval t has expired, the output relay R switches into on-position (yellow LED illuminated) and the set interval t begins again. After the interval t has expired. the output relay switches into off-position (yellow LED not illuminated). The output relay is triggered at a ratio of 1:1 until the supply voltage is interrupted.



• **Asymmetric flasher pause first (Ip)**

When the supply voltage U is applied, the set interval t1 begins (green LED U/t flashes slowly) After the interval t1 has expired. the output relay R switches into on-position (yellow LED illuminated) and the set interval t2 begins (green LED U/t flashes fast). After the interval t2 has expired, the output relay switches into off-position (yellow LED not illuminated). The output relay is triggered at the ratio of t1:t2 until the supply voltage is interrupted.

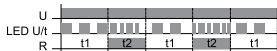

• **Asymmetric flasher pulse first (Ii)**

When the supply voltage U is applied, the output relay R switches into on-position (yellow LED illuminated) and the set interval t1 begins (green LED U/t flashes slowly). After the interval t1 has expired, the output relay switches into off-position (yellow LED not illuminated) and the set interval t2 begins (green LED U/t flashes fast). After the interval t2 has expired, the output relay switches into on-position (yellow LED illuminated). The output relay is triggered at the ratio of t1:t2 until the supply voltage is interrupted.



Switching voltage	$U_N$	Contactors	Type Designation	Article No.	Units per package
-------------------	-------	------------	------------------	-------------	-------------------

### Undervoltage Relay REUVM

- Optical indication
  - Relay active ... green LED
  - Fault in phases L1, L2, L3 ... red LED is flashing
  - Loss of Neutral conductor N ... green LED is flashing
- Single phase application is possible

SG83511



$U_N \times 0.85$	230/400 VAC	1CO	REUVM	148598	1
$U_N \times 0.85$	230/400 VAC	2CO	REUVM2	167284	1

### Description Undervoltage Relay REUVM

- When the connection to the three phases and neutral conductor is made the relay is energized in case there is no fault and the green LED lights. If the monitored nominal voltage  $U_N$  drops under the switching voltage  $U_S$ , in one, two or all three phases the relay reverts to its de-energized position. The green LED disappear.
- Optical indication
  - Relay active ... green LED
  - Fault in phases L1, L2, L3 ... red LED is flashing
  - Loss of Neutral conductor N ... green LED is flashing
- Single-phases operation: bridge L1-L2-L3

### Technical Data

		REUVM
<b>Electrical</b>		
Rated operational voltage	$U_N$	230/400 V AC
Rated frequency		50-60 Hz
Switching voltage	$U_S$	$U_N \times 0.85$ fix
Power consumption		< 1 VA
Switching time delay		500 ms
Switching contact		1 CO, 2 CO
Rated operational voltage / current		250 VAC / 5A $\cos\phi = 1$ 30 VDC / 5A 300 VDC / 0.25A
Min. Rated operational voltage		100 mV AC/DC
Min. Rated operational current		10 mA AC/DC
Rated peak withstand voltage		4 kV
Duty		100%
Overvoltage category		III
Dielectric strength		
Coil – contact circuit		4 kV <sub>r.m.s.</sub>
Open circuit contact		1 kV <sub>r.m.s.</sub>
<b>Mechanical</b>		
Frame size		45 mm
Device height		90 mm
Device width		17.8 mm
Weight		65 g, 73 g
Mounting		quick fastening on DIN rail IEC/EN 60715
Degree of protection, built-in		IP40
Upper and lower terminals		lift terminals
Terminal capacity		
solid		1x4 mm <sup>2</sup> , 2x1.5 mm <sup>2</sup>
fine-wire		1x2.5 mm <sup>2</sup>
Tightening torque of terminal screws		0.5 Nm
Resistance to climatic conditions		F / DIN 40040
Temperature range		-25 to +60 °C
Flame class		V0, glow wire 960 °C
Pollution degree		2
Comparative tracking index		CTI 600

Connection diagram

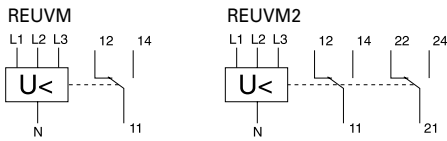

Single-phases application

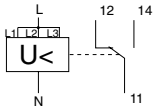

Dimensions (mm)

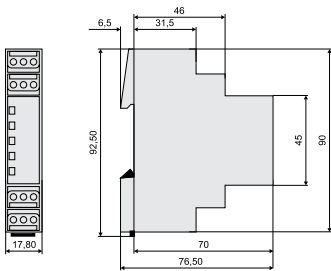

Functional diagram

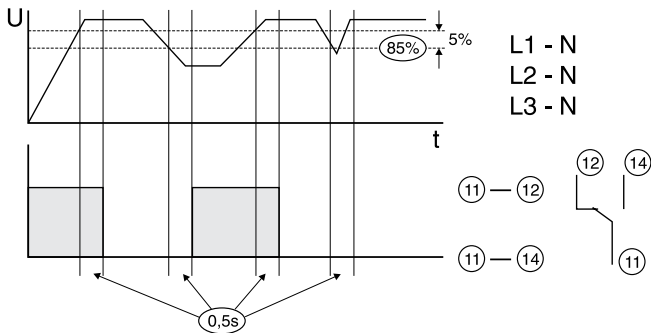

Optical indication and contact position

Operation

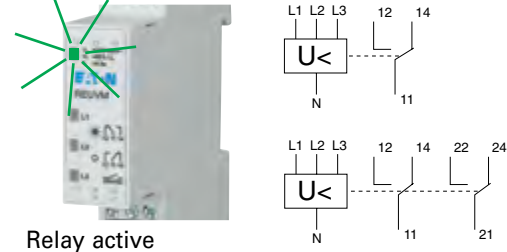

Relay active

Fault

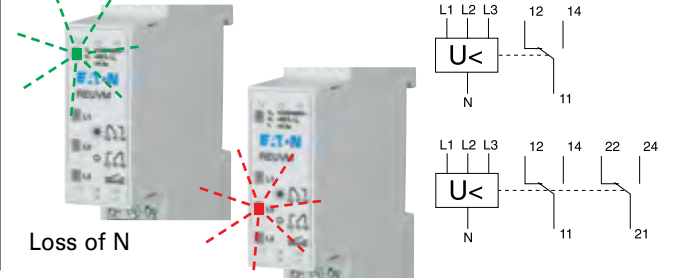

Loss of N

Example Phase L2



Rated operational voltage

Type  
Designation

Article No.

Units per  
package**Voltage Indication UVA**

- Optical indication  
Voltage of phases L1, L2, L3 is indicated with green LED's even at loss of Neutral conductor N
- Single-phases application, or even possible to use DC

SG00112



230/400 V AC, 50/60 Hz

UVA

167285

1

**Description Voltage Indication UVA**

- When the connection to the three phases and neutral conductor is made, the green Power LED lights. If only two phases are connected, eg. L1 and L3, only these green LED's lights, even at loss of Neutral conductor N.
- For use as voltage return indication in manual operated Mains-Emergency-system operation
- Large operational voltage range 85-480 V AC, 85-300 V DC

**Technical Data**

		UVA
<b>Electrical</b>		
Rated operational voltage	$U_N$	230/400 V AC
Rated frequency		50-60 Hz
Rated operational voltage range		
L-L		85-480 V AC
L-N		85-300 V AC/DC
Power consumption at 400 V AC		3x 23 mW
Max. permissible back-up fuse		16A gG (gL)
Duty		100%
Rated peak withstand voltage		6 kV
Overvoltage category		IV
<b>Mechanical</b>		
Frame size		45 mm
Device height		90 mm
Device width		17.8 mm
Weight		42 g
Mounting		quick fastening on DIN rail IEC/EN 60715
Degree of protection, built-in		IP40
Upper and lower terminals		lift terminals
Terminal capacity		
solid		1x4 mm <sup>2</sup> , 2x1.5 mm <sup>2</sup>
fine-wire		1x2.5 mm <sup>2</sup>
Tightening torque of terminal screws		0.5 Nm
Temperature range		-30 to +60°C
Flame class		V0, glow wire 960 °C
Pollution degree		2
Comparative tracking index		CTI 600

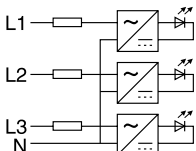
**Connection diagram**

Dimensions (mm)

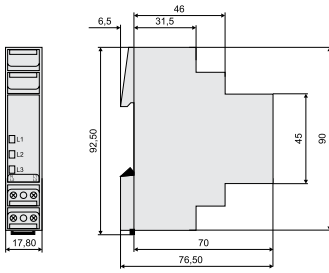

Application and visuelle indicators

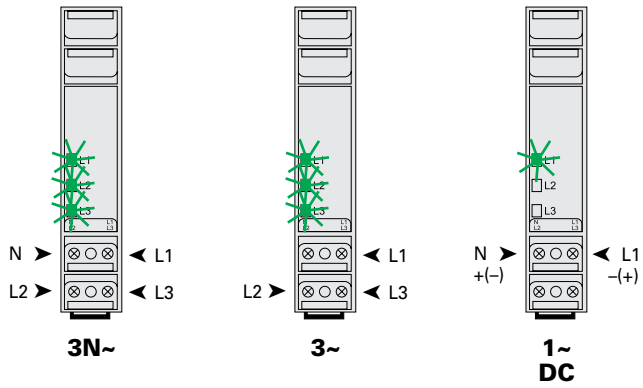

SG78711



Function	Rated operational current range (A)	Type Designation	Article No.	Units per package
<b>Load Shedding (Current) Relay Z-LAR</b>				
NC	3-8	Z-LAR/8-O	248256	1 / 60
NC	10-16	Z-LAR/16-O	248257	1 / 60
NC	15-32	Z-LAR/32-O	248258	1 / 60
NO	3-8	Z-LAR/8-S	248259	1 / 60
NO	10-16	Z-LAR/16-S	248260	1 / 60
NO	15-32	Z-LAR/32-S	248261	1 / 60
CO	3-8	Z-LAR/8-W	248262	1 / 60

### Description Load Shedding (Current) Relay Z-LAR

- For simple priority connection of important consumers
- For fast current increase
- Expensive peak loads are avoided efficiently (staggered heating)
- Integrated auxiliary switch, 1 NC or 1 NO or 1 CO contact
- NC and NO contact are potential free

### Technical Data

		Z-LAR/8	Z-LAR/16	Z-LAR/32
<b>Electrical</b>				
Nominal thermal current	$I_{th}$	8 A	16 A	32 A
Rated voltage	U	250 V AC	250 V AC	250 V AC
Responding current	$I_{AN}$	$\geq 3$ A	$\geq 10$ A	$\geq 15$ A
Release current	$I_A$	$\leq 1.8$ A	$\leq 4.2$ A	$\leq 7.4$ A
Max. electrical switching frequency		3600/h	3600/h	3600/h
Rated insulation voltage	$U_i$	440 V	440 V	440 V
Power loss at $I_{th}$				
Effective power		3.4 W	1.95 W	3.17 W
Apparent power		7.7 VA	4.66 VA	7.36 VA
Rated peak withstand voltage	$U_{imp}$	4 kV	4 kV	4 kV
Back-up fuse line protection		max. 10 A	max. 16 A	max. 32 A
Switching contact				
Function NC, NO, CO				
Back-up fuse		max. 1 A gL	max. 1 A gL	max. 1 A gL
Contact gap *)		< 3 mm ( $\mu$ )	< 3 mm ( $\mu$ )	< 3 mm ( $\mu$ )
Breaking capacity		1 A / 250 V~	1 A / 250 V~	1 A / 250 V~
Minimum switching capacity		300 mW	300 mW	300 mW
Minimum operational voltage		12 V	12 V	12 V
Endurance electrical components		100,000 switching operations		
*) Do not use as the only means of isolating a device from the line voltage				
<b>Mechanical</b>				
Frame size		45 mm	45 mm	45 mm
Device height		80 mm	80 mm	80 mm
Device width		17.5 mm (1MU)	17.5 mm (1MU)	17.5 mm (1MU)
Mounting		quick fastening on DIN rail IEC/EN 60715		
Degree of protection, built-in		IP40	IP40	IP40
Terminal protection		finger and hand touch safe according to DGUV VS3, EN 50274		
Upper and lower terminals		lift terminals	lift terminals	lift terminals
Terminal capacity				
Main circuit		2 x 10 mm <sup>2</sup>	2 x 10 mm <sup>2</sup>	2 x 10 mm <sup>2</sup>
Auxiliary circuit		2 x 2.5 mm <sup>2</sup>	2 x 2.5 mm <sup>2</sup>	2 x 2.5 mm <sup>2</sup>
Tightening torque of terminal screws				
Main circuit		max. 2.4 Nm	max. 2.4 Nm	max. 2.4 Nm
Auxiliary circuit		max. 1 Nm	max. 1 Nm	max. 1 Nm

Connection diagram

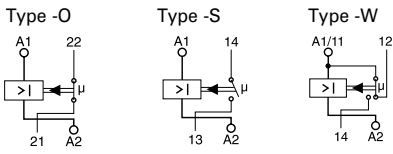

Dimensions (mm)

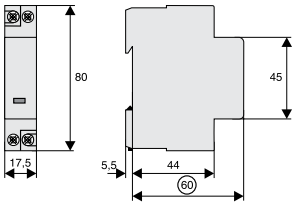

Connection Example - Operating Status

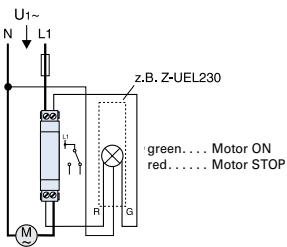

Connection Example - Priority for Pump

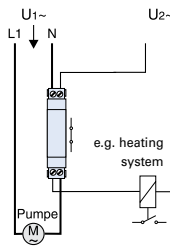

Connection Example - „OR“ Circuit, Extraction System

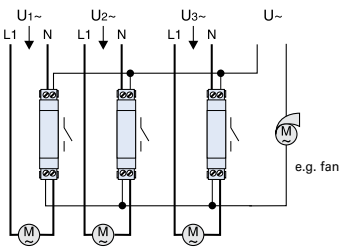

Drive	Program	Channels	Type Designation	Article No.	Units per package
-------	---------	----------	------------------	-------------	-------------------

#### Digital Timers TSDW

sg06219\_1



Digital	Week	1 channel	TSDW1COMIN	167383	1
Digital	Week	1 channel	TSDW1CO-1	196848	1
Digital	Week	2 channels	TSDW2CO-1	196849	1

Description	Type Designation	Article No.	Units per package
-------------	------------------	-------------	-------------------

#### Accessories

sg06012



Memory card	TSAMEM	167387	1
-------------	--------	--------	---

**Description Digital Timers with a Weekly Program TSDW1CO, TSDW2CO**

- Spring terminals
- Text-based user guidance on the display
- 56 memory cells
- Interface for memory card
- 10 years power backup (lithium battery)
- Zero-cross switching for a relay-saving way of switching and for high lamp loads
- ON-OFF switching times
- Pre-selected switching
- Permanent ON/OFF switching
- Integrated counter for operating hours
- Vacation program
- Display background lighting (can be switched off)
- PIN coding
- Automatic spring forward/fall back at daylight-saving start and end dates
- TSDW1CO: 1 channel
- TSDW2CO: 2 channels

**Technical Data**

	TSDW1CO-1	TSDW2CO-1
<b>Electrical</b>		
Rated operational voltage	230 V AC	230 V AC
Frequency	50 – 60 Hz	50 – 60 Hz
Stand-by Power (typical)	0.4 W	0.4 W
Power backup	10 years	10 years
Accuracy (typical)	± 0.25 s/day at 25 °C (quartz)	± 0.25 s/day at 25 °C (quartz)
Switching capacity		
at 250 V AC, $\cos\varphi = 1$	16A	16A
at 250 V AC, $\cos\varphi = 0.6$	10A	10A
Incandescent/halogen lamp load	2600 W	2600 W
Energy saving lamps 230 V	1100 W	1100 W
LED lamp < 2 W	50 W	50 W
LED lamp > 2 W	600 W	600 W
Fluorescent lamp load (conventional)		
not corrected	2600 VA	2600 VA
series corrected	2600 VA	2600 VA
parallel corrected	1300 VA 130 µF	1300 VA 130 µF
Min. switching capacity	ca.10 mA	ca.10 mA
Shortest switching time	1 min	1 min
<b>Mechanical</b>		
Frame size	45 mm	45 mm
Device width	36 mm	36 mm
Mounting	DIN rail	DIN rail
Width	2 modules	2 modules
Type of connection	Duo fix spring terminals	Duo fix spring terminals
Ambient temperature	-30 °C to +60 °C	-30 °C to +60 °C
Degree of protection	IP20	IP20
Protection class	II according to EN 60730-1	II according to EN 60730-1
Certification mark	V	V

**Connection example**



**Dimensions (mm)**

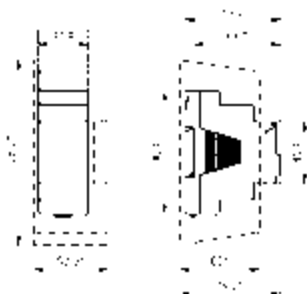

### Description Digital Timers with a Weekly Program TSDW1COMIN

- 1 channel
- Screw-type terminals
- Text-based operator guidance on the display
- 84 memory cells
- 3 years Power backup (exchangeable lithium battery)
- ON-OFF switching times
- Pre-selected switching
- Permanent ON/OFF switching
- PIN coding
- Automatic spring forward/fall back at daylight-saving start and end dates

### Technical Data

	TSDW1COMIN
<b>Electrical</b>	
Rated operational voltage	230 V AC
Frequency	50–60 Hz
Power backup	3 years
Breaking capacity	
at 250 V AC, $\cos\varphi = 1$	16 A
at 250 V AC, $\cos\varphi = 0.6$	6 A
Incandescent/halogen lamp load	1000 W
Shortest switching time	1 min
Accuracy	$\leq \pm 1$ s/day (quartz)
Stand-by Power	0.4 W
<b>Mechanical</b>	
Frame size	45 mm
Device width	17.5 mm
Mounting	DIN rail
Degree of protection	IP20
Protection class	II according to EN 60730-1
Ambient temperature	-10 to +55 °C
Certification mark	V

### Connection example

TSDW1COMIN

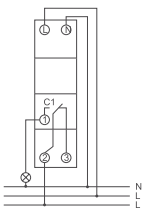

### Dimensions (mm)

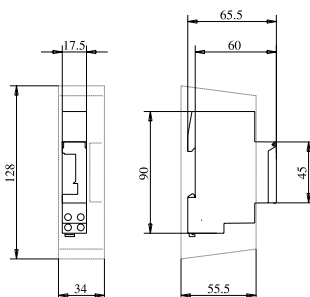

Drive	Program	Channels	Type Designation	Article No.	Units per package
-------	---------	----------	------------------	-------------	-------------------

**Astronomical Timer with a Weekly Program TSDW1COA**

sg06119\_1



Quartz	Week	1 channel	TSDW1COA	PHASE OUT	167381	1
Quartz	Week	1 channel	TSDW1COA-1	NEW	196850	1

**Description Astronomical Timer with a Weekly Program TSDW1COA**

- Astronomical switching function (automatic calculation of sunrise and sunset times for the entire year)
- Spring terminals
- Text-based user guidance on the display
- Interface for memory card
- 10 years power backup (lithium battery)
- Zero-cross switching for a relay-saving way of switching and for high lamp loads
- Calculated astronomical switching times
- Programmable ON/OFF switching times
- Pre-selected switching
- Permanent ON/OFF switching
- Integrated counter for operating hours
- Vacation program
- Display background lighting (can be switched off)
- PIN coding
- Automatic spring forward/fall back at daylight-saving start and end dates
- 1 channel
- 54 memory cells



### Technical Data

	<b>TSDW1C0A</b>	<b>PHASE OUT</b>	<b>TSDW1C0A-1</b>	<b>NEW</b>
<b>Electrical</b>				
Rated operational voltage	230–240 V AC		230 V AC	
Frequency	50–60 Hz		50 – 60 Hz	
Stand-by Power (typical)	0.8 W		0.4 W	
Power backup	10 years		10 years	
Accuracy (typical)	≤ ± 0.5 s/day (quartz)		at 25 °C typical ± 0.25 s/day (quartz)	
Switching capacity				
at 250 V AC, $\cos\varphi = 1$	16 A		16A	
at 250 V AC, $\cos\varphi = 0.6$	10 A		10A	
Incandescent/halogen lamp load	2600 W		2600 W	
Energy saving lamps 230 V	22 x 7 W, 18 x 11 W, 16 x 15 W, 16 x 20 W, 14 x 23 W		1100 W	
LED lamp < 2 W			50 W	
LED lamp > 2 W			600 W	
Fluorescent lamp load (conventional)				
not corrected	2300 VA		2600 VA	
series corrected	2300 VA		2600 VA	
parallel corrected	730 VA, 80 µF		1300 VA 130 µF	
Min. switching capacity	ca.10 mA		ca.10 mA	
Shortest switching time	1 min		1 min	
<b>Mechanical</b>				
Frame size	45 mm		45 mm	
Device width	36 mm		36 mm	
Mounting	DIN rail		DIN rail	
Width	2 modules		2 modules	
Type of connection	DuoFix spring terminals		DuoFix spring terminals	
Ambient temperature	-30 to +55 °C		-30 to +55 °C	
Degree of protection	IP20		IP20	
Protection class	II according to EN 60730-1		II according to EN 60730-1	
Certification mark	V		V	

### Connection example

TSDW1C0A / TSDW1C0A-1

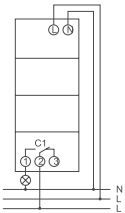

### Dimensions (mm)

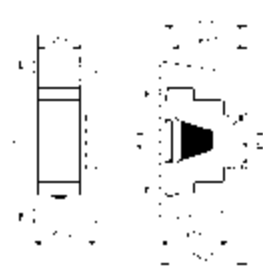

Drive	Program	Channels	Type Designation	Article No.	Units per package
-------	---------	----------	------------------	-------------	-------------------

**Analogue Timers TS**

SG83911



Quartz	Day	1 channel	TSQD1NO	167388	1
Synchron	Day	1 channel	TSSD1NO	167389	1
Quartz	Day	1 channel	TSQD1CO	167390	1
Synchron	Day	1 channel	TSSD1CO	167391	1
Quartz	Week	1 channel	TSQW1CO	167392	1

### Description Analogue Timers TSQD1NO, TSSD1NO

- 1 MU
- 1 channel
- Screw-type terminals
- Manual switch with 3 positions: Permanent ON/AUTO/Permanent OFF
- Switching status indication
- TSQD1NO: with power backup (Internal rechargeable battery)
  - Quartz-controlled
- TSSD1NO: Daily program
  - Without power backup
  - 96 switching segments
  - Mains-synchronized
  - Shortest switching time: 15 minutes

### Technical Data

	TSQD1NO	TSSD1NO
<b>Electrical</b>		
Rated operational voltage	230–240 V AC	230 V AC
Frequency	50–60 Hz	50 Hz
Program	Daily program	Daily program
Power backup	3 days	–
Breaking capacity		
at 250 V AC, $\cos\varphi = 1$	16 A	16 A
at 250 V AC, $\cos\varphi = 0.6$	4 A	4 A
Shortest switching time	15 min	15 min
Programmable	every 15 min	every 15 min
Accuracy	$\leq \pm 1$ s/day (quartz)	Mains-synchronized
Stand-by Power	0.5 W	0.9 W
<b>Mechanical</b>		
Frame size	45 mm	45 mm
Device width	17.5 mm	17.5 mm
Mounting	DIN rail	DIN rail
Degree of protection	IP20	IP20
Protection class	II according to EN 60730-1	II according to EN 60730-1
Ambient temperature	-10 to +55 °C	-25 to +55 °C
Certification mark	V	V

### Connection example

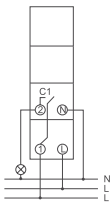

### Dimensions (mm)

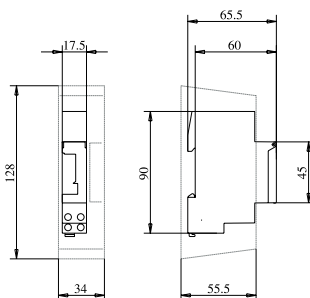

**Description Analogue Timers TSQD1CO, TSSD1CO, TSQW1CO**

- 3 MU
- 1 channel
- Spring terminals
- Pre-selected switching
- Manual switch with 3 positions: Permanent ON/AUTO/Permanent OFF
- Switching status indication
- TSQD1CO:
  - With power backup (NiMH cell)
  - Quartz-controlled
  - Clock-hands for time indication and 12h/24h recognition
  - Easy correction of spring forward/fall back at daylight-saving start and end
- TSQW1CO:
  - Weekly program
  - 84 switching segments
  - Shortest switching time: 2 hours
- TSSD1CO:
  - Daily program
  - Without power backup
  - 96 switching segments
  - Shortest switching time: 15 minutes
  - Clock-hands for time indication and 12h/24h recognition
  - Easy correction of spring forward/fall back at daylight-saving start and end

**Technical Data**

	TSQD1CO	TSSD1CO	TSQW1CO
<b>Electrical</b>			
Rated operational voltage	110–230 V AC	110–230 V AC	110–230 V AC
Frequency	50–60 Hz	50 Hz	50–60 Hz
Program	Daily program	Daily program	Weekly program
Power backup	200 hours, approx. 100 hours– at 110 V		200 hours, approx. 100 hours at 110 V
Breaking capacity			
at 250 V AC, $\cos\varphi = 1$	16 A	16 A	16 A
at 250 V AC, $\cos\varphi = 0.6$	4 A	4 A	4 A
Shortest switching time	15 min	15 min	2 h
Programmable	every 15 min	every 15 min	alle 2 h
Accuracy	$\leq \pm 1$ s/day (quartz)	Mains-synchronized	$\leq \pm 1$ s/day (quartz)
Stand-by Power	0.5 W	0.9 W	0.5 W
<b>Mechanical</b>			
Frame size	45 mm	45 mm	45 mm
Device width	52.5+1.5 mm	52.5+1.5 mm	52.5+1.5 mm
Mounting	DIN rail	DIN rail	DIN rail
Degree of protection	IP20	IP20	IP20
Protection class	II according to EN 60730-1	II according to EN 60730-1	II according to EN 60730-1
Ambient temperature	-20 to +55 °C	-20 to +55 °C	-20 to +55 °C
Certification mark	V	V	V

**Connection example**

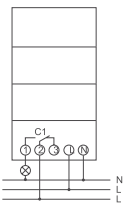

**Dimensions (mm)**



### Light Intensity Switch SR

Switching contact	Brightness range	Brightness adjustable	Mounting	DIN rail Size	Type Designation	Article No.	Units per package
-------------------	------------------	-----------------------	----------	---------------	------------------	-------------	-------------------

#### Light Intensity Switch SRSD

sg06019\_l



1NO	2-2000 Lux	Analog	DIN rail	1TE	SRSD1NOW	196845	1
-----	------------	--------	----------	-----	----------	--------	---

#### Light Intensity Switch SRSW

sg05819\_r



1NO	2-100 / 100-2000 Lux	Analog, Digital	Wall		SRSW1NOW	196846	1
-----	----------------------	-----------------	------	--	----------	--------	---

#### Light Intensity Switch with timer SRC

sg05919\_l



1NO	1-99000 Lux	Digital	DIN rail	2TE	SRC1COD	196847	1
-----	-------------	---------	----------	-----	---------	--------	---

**Description Light Intensity Switch analog for DIN rail SRSD1NOW**

- Analog twilight switch
- External surface-mounted light sensor, cadmium sulfide (CdS) free
- Indication of the channel and switching status
- Freely adjustable switching brightness
- Wide lux range: 2 - 2000 lux
- Fixed on/off switching delay, preventing faulty operation caused by lightning, car headlights, etc.
- Improved switching capabilities: LED 350W (>2W)
- Reduced Power standby: -0,3 W

**Technical Data**

<b>SRSD1NOW</b>	
<b>Electrical</b>	
Rated operational voltage	230 V AC, +10%/-15%
Frequency	50–60 Hz
Stand-by Power (typical)	0.3 W
Setting range for brightness	2-2000 lx
Switch-on delay	20 s
Switch-off delay	80 s
Contact type	NO
Switch output	Potential-free
Switching capacity	
at 250 V AC, $\cos\phi = 1$	16 A
Fluorescent lamp	10 AX
Incandescent/halogen lamp load	2600 W
Energy saving lamps	
LED lamp < 2 W	30 W
LED lamp > 2 W	350 W
Fluorescent lamp load (conventional)	
not corrected	2300 VA
series corrected	2300 VA
parallel corrected	730 VA, 80 $\mu$ F
Fluorescent lamp (electronic ballast)	650 VA
Min. switching capacity	<10 mA
<b>Mechanical</b>	
Frame size	45 mm
Device width	17.5 mm
Mounting	DIN rail
Width	1 module
Connection	Screw terminals
Ambient temperature	-30 °C to +55 °C
Sensor temperature range	-40 °C to +70 °C
Degree of protection	IP20, Sensor IP 55
Protection class	II
Certification mark	V
Max. line length to the sensor	25 m

**Connection diagram**

SRSD1NOW

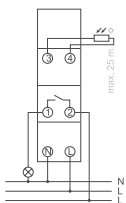

**Dimensions (mm)**

SRSD1NOW

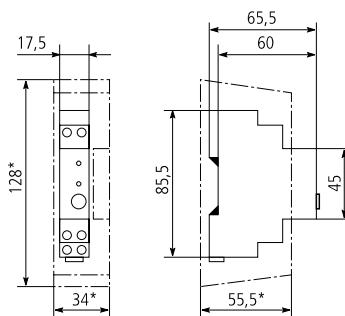

**Description Surface-Mounted Light Intensity Switch SRSW1NOW**

- Twilight switch with an integrated light sensor
- Cable entry is possible at the rear or from the bottom
- Large terminal area
- Setting the brightness value is possible from outside, without the need to open the device
- Wide angle of light incidence (approx. 180°)
- Transparent cover: High exposure to light
- Selectable Lux range button: 2 - 100 lux / 100 - 2000 lux
- Brightness Teach-in button: set current brightness value directly
- Timer function button: switch on light for 1 hour timer
- Manual operation button: switch on/off light until next sensor switch off/on event
- Switch-on and switch-off delay can be adjusted

**Technical Data**

<b>SRSW1NOW</b>	
<b>Electrical</b>	
Rated operational voltage	230 V AC, +10%/-15%
Frequency	50–60 Hz
Stand-by Power (typical)	0.7 W
Setting range for brightness	I: 2–100 lx; II: 100–2000 lx
Preset brightness value	15 lx
Switch-on/off delay	2-100 s
Contact type	NO
Switch output	Not potential-free (230 V)
Switching capacity	
at 250 V AC, $\cos\varphi = 1$	16 A
at 230 V AC, $\cos\varphi = 0.3$	10 AX
Min. switching capacity	10 mA/230V AC
Incandescent/halogen lamp load	2300 W
Energy saving lamps	
LED lamp < 2 W	50 W
LED lamp 2-8 W	600 W
LED lamp > 2 W	600 W
Fluorescent lamp load (conventional)	
not corrected	2300 VA
series corrected	2300 VA
parallel corrected	1300 VA, 130 $\mu$ F
Fluorescent lamp (electronic ballast)	1100 W
Compact fluorescent lamp (electronic ballast)	300 W
<b>Mechanical</b>	
Hight	118.4 mm
Width	85 mm
Depth	49.4 mm
Mounting	Wall mounted
Connection	Screw terminals
Ambient temperature	-35 °C to +55 °C
Degree of protection	IP 55
Protection class	II
Certification mark	V

**Connection diagram**

SRSW1NOW

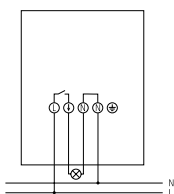
**Dimensions (mm)**

SRSW1NOW

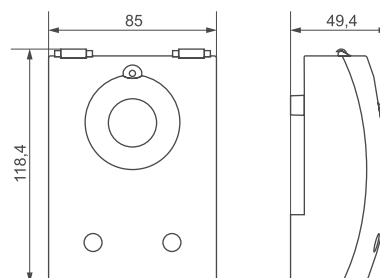

**Description Light Intensity Switch with Timer for DIN Rail SRCD1COD**

- Twilight switch with an integrated weekly timer
- External light sensor included in delivery
- 1 channel
- External input
- 3 special programs (small annual program)
- Pulse program
- 84 memory locations
- Switching brightness digitally adjustable
- Adjustable On and Off switching delay
- Switching brightness and switching delay can be set separately for switching On and Off
- Onscreen display of channel and switching status as well as current lux value
- Zero-cross switching for relay-saving switching and high lamp loads
- Up to 4 sensors can be attached
- Up to 10 devices can be connected to a digital sensor
- Extended brightness range
- Permanent switching ON/OFF
- Test function
- Switching preselection
- Display back light (can be turned off)
- PIN coding
- Operating hour counter
- DuoFix spring terminals

**Technical Data**

<b>SRCD1COD</b>	
<b>Electrical</b>	
Rated operational voltage	110 – 230 V AC, +10%/-15%
Frequency	50 – 60 Hz
Stand-by Power (typical)	0.8 W
Power reserve	10 years at 20 °C
Setting range for brightness	1 – 99000 lx
Preset brightness value	15 lx
Switch-on/off delay	0 – 59 min
Number of channels	1
Number of memory locations	84
External inputs	1
Accuracy (typical)	± 0,25 s/day at 25 °C (quartz)
Keyboards	4 touch buttons
Shortest switching times	1 min
Contact type	Changeover contact
Switching output	Switching of any external conductor is permitted
Switching capacity	
at 230 V AC, $\cos\varphi = 1$	16 A
at 230 V AC, $\cos\varphi = 0.6$	10 A
Incandescent/halogen lamp load	2600 W
Fluorescent lamp load (conventional)	
not corrected	2600 VA
series corrected	1300 VA (130 µF)
parallel corrected	1100 W
Energy saving lamps	
LED lamp < 2 W	50 W
LED lamp > 2 W	600 W
<b>Mechanical</b>	
Frame size	45 mm
Device width	36 mm
Mounting	DIN rail
Width	2 modules
Type of connection	DuoFix spring terminals
Ambient temperature	-25°C ... 55°C, sensor -40 °C ... +70 °C
Type of protection	IP 20, sensor IP 55
Protection class	II, Sensor III
Max. cable length to sensor	100 m

**Connection diagram**

SRCD1CO

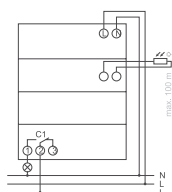

SRCD1COD

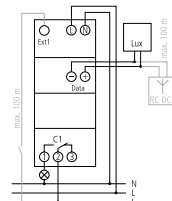

**Dimensions (mm)**

SRCD1CO

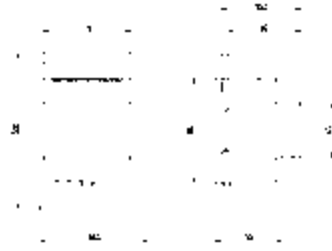

SRCD1COD

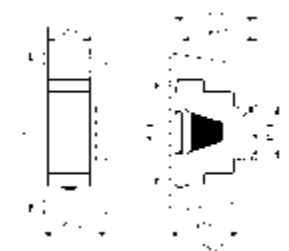





MU	Secondary voltage (V)	Secondary current (A)	Type Designation	Article No.	Units per package
<b>Bell-Transformers 230 V, TR-G</b>					
2	8	1	TR-G/8	272480	1 / 28
2	4-8-12	1-1-0.67	TR-G3/8	272481	1 / 28
2	8	1	TR-G/8-S	272482	1 / 28
2	4-8-12	2-2-1.5	TR-G3/18	272483	1 / 28
3	12-24	2-1	TR-G2/24	272484	1 / 20

SG82911



**Description Bell-Transformers 230 V, TR-G**

- Type -S with primary switch
- Accessories: Surface Mounting Set (mounting plate, terminal covers)

**Technical Data**

	TR-G/8	TR-G3/8	TR-G/8-S	TR-G3/18	TR-G2/24
<b>Electrical</b>					
Nominal power	8 VA	8 VA	8 VA	18 VA	24 VA
Rated supply voltage range at terminals	230-240 V AC	230-240 V AC	230-240 V AC	230-240 V AC	230-240 V AC
Rated frequency	50 Hz	50 Hz	50 Hz	50 Hz	50 Hz
No-load current	25 mA	26 mA	25 mA	36 mA	24 mA
Rated supply current	69 mA	58 mA	69 mA	72/124/138 mA	155/160 mA
Primary resistance	616 Ω	667 Ω	616 Ω	229 Ω	616 Ω
Rated output voltage at terminals	8 V AC	4/8/12 V AC	8 V AC	4/8/12 V AC	12/24 V AC
No-load output voltage	13 V	4.9/12/16.8 V	13 V	5.9/12/17.8 V	16/31 V
Rated output voltage at rated output current	8.4 V	3.8/7.9/12.2 V	8.4 V	4.3/8.4/12.7 V	12.2/23.2 V
Secondary resistance	2 Ω	0.9/1.9/2.8 Ω	2 Ω	0.4/1/1.3 Ω	1/3 Ω
Power loss in no-load operation	1.4 W	1.4 W	1.4 W	1.8 W	1.9 W
Total power loss at nominal load	7.1 W	6.2 W	7.1 W	11.6 W	11.9 W
Short circuit proof	PTC	PTC	PTC	PTC	PTC
Test voltage (primary-secondary)	5 kV	5 kV	5 kV	5 kV	5 kV
Pollution degree	P2	P2	P2	P2	P2
<b>Mechanical</b>					
Frame size	45 mm	45 mm	45 mm	45 mm	45 mm
Device height	90 mm	90 mm	90 mm	90 mm	90 mm
Device width	36 mm	36 mm	36 mm	36 mm	54 mm
Weight	236 g	253 g	236 g	354 g	612 g
Mounting	quick fastening on DIN rail IEC/EN 60715				
Degree of protection, built-in	IP20	IP20	IP20	IP20	IP20
Upper and lower terminals	lift terminals	lift terminals	lift terminals	lift terminals	lift terminals
Terminal capacity	1 - 3x2.5 mm <sup>2</sup>	1 - 3x2.5 mm <sup>2</sup>	1 - 3x2.5 mm <sup>2</sup>	1 - 3x2.5 mm <sup>2</sup>	1 - 3x2.5 mm <sup>2</sup>
Tightening torque of terminal screws	0.5 Nm	0.5 Nm	0.5 Nm	0.5 Nm	0.5 Nm
Permitted relative air humidity	<95%	<95%	<95%	<95%	<95%
Rated ambient temperature	40 °C	40 °C	40 °C	40 °C	35 °C
Temperature rise at intermittent duty (20 x 1 min. 100% and 5 min. 20%)	24 K	24 K	24 K	26 K	31 K
Insulation class	E	E	E	E	E
Glow wire-test enclosure	850 °C	850 °C	850 °C	850 °C	850 °C

**Connection diagram (e.g.)**

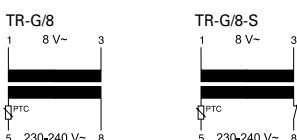

Bell transformer



Short circuit-proof transformer

### Dimensions (mm)

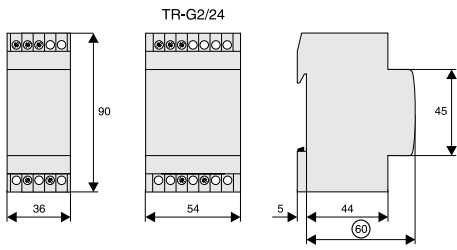

MU	Secondary voltage (V)	Secondary current (A)	Type Designation	Article No.	Units per package
<b>Safety-Transformer 230V, TR-G2/63-SF</b>					
5	12-24	5.2-2.6	TR-G2/63-SF	272485	1 / 12

SG42512



**Description Safety-Transformer 230V, TR-G2/63-SF**

- 100% duty
- Safety transformer with separate windings according to EN 61558
- Accessories: Surface Mounting Set (mounting plate, terminal covers)

**Technical Data**

	<b>TR-G2/63-SF</b>
<b>Electrical</b>	
Nominal power	63 VA
Rated supply voltage range at terminals	230-240 V AC 7-12
Rated frequency	50 Hz
No-load current	60 mA
Rated supply current	340 mA
Primary resistance	41 Ω
Rated output voltage at terminals	12/24 V AC 1-4/1-4 (terminal connection)
No-load output voltage	13.6/27.3 V
Rated output voltage at rated output current	12/24.1 V 5.2-2.6 A
Secondary resistance	0.15/0.6 Ω
Power loss in no-load operation	4.1 W
Total power loss at nominal load	19.6 W
Duty	100%
Short circuit proof	inherently (PTC)
Test voltage (primary-secondary)	5 kV
Pollution degree	P2
<b>Mechanical</b>	
Frame size	45 mm
Device height	90 mm
Device width	90 mm
Weight	1256 g
Mounting	quick fastening on DIN rail IEC/EN 60715
Degree of protection, built-in	IP20
Upper and lower terminals	lift terminals
Terminal capacity	1 - 3x2.5 mm <sup>2</sup>
Tightening torque of terminal screws	0.5 Nm
Permitted relative air humidity	<95%
Rated ambient temperature	25 °C
Temperature rise at uninterrupted duty	51 K
Insulation class	F
Glow wire-test enclosure	850 °C

**Connection diagram (e.g.)**

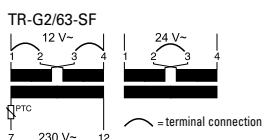

Safety transformer according to EN 61558  
(Fail-safe = no danger in case of failure)

Short-circuit-proof trans-  
former

### Dimensions (mm)

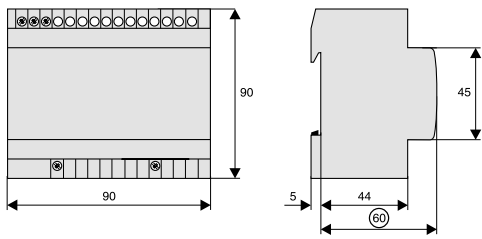

Function	Rated voltage (V-)	Type Designation	Article No.	Units per package
<b>Signalling Devices AS</b>				
Bell	230 V AC	ASBELL230	167393	1
Bell	12 V AC	ASBELL12	167394	1
Buzzer	230 V AC	ASBUZZ230	167395	1
Siren	24 V AC/DC	ASSIR24	167396	1

wa\_eg04311



ASBELL230

**Description Bell ASBELL, Buzzer ASBUZZ230**

- Signal bells and buzzers are typically used in residential buildings and in functional buildings such as shops, offices, banks etc. They are either used to signalize alert conditions, or generally as audible sound signals.
- These devices are built-in devices installed in distribution cabinets. They are designed for short-time operation in compliance with the IEC 62080 standard.
- Space-saving design of one module unit only.
- Safe device protection thanks to PTC to avoid overloads and short-circuits.

**Technical Data**

		ASBELL230, ASBUZZ230	ASBELL12
<b>Electrical</b>			
Standards		IEC 62080	IEC 62080
Rated operational voltage	$U_b$	230 V AC	12 V AC
Rated operational power	$P_s$	5.5 VA	4 VA
Working range 50/60 Hz		$0.94 \dots 1.06 \times U_c$	$0.94 \dots 1.06 \times U_c$
Rated frequency		50 Hz	50 Hz
Working range of frequency		45 ... 65 Hz	45 ... 65 Hz
Rated power loss in idle operation	$P_v$	0.83 W	0.83 W
Pollution degree according to EN 61010-1		2	2
Operating voltage according to EN 61010-1		230 V AC	12 V AC
Insulating material group according to EN 61010-1		II	II
Safe separation			
Air gap		$\geq 3 \text{ mm}$	$\geq 1.5 \text{ mm}$
Creep distance within the device		$\geq 2.5 \text{ mm}$	$\geq 1.5 \text{ mm}$
Test voltage 50 Hz, 1 min.		1.25 kV	1 kV
Flammability class		V0	V0
Terminal capacity			
solid		$1 \times 6 \text{ or } 2 \times 4 \text{ mm}^2$	$1 \times 6 \text{ or } 2 \times 4 \text{ mm}^2$
flexible with wire end sleeve, min.		$0.75 \text{ mm}^2$	$0.75 \text{ mm}^2$
Sound volume		$\geq 75 \text{ dB}$	$\geq 75 \text{ dB}$
Permitted ambient temperature		-10 to +55 °C	-10 to +55 °C
Degree of protection according to DIN EN 60529		IP20, with angeschlossenen wiresn	IP20, with angeschlossenen wiresn
Protection class according to DIN EN 61140 / VDE 0140		II	II

**Connection diagram**

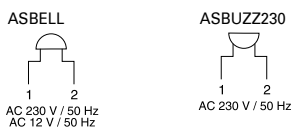

**Dimensions (mm)**

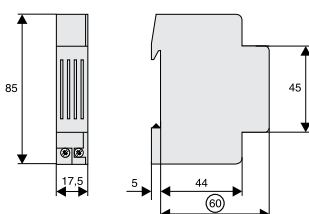

**Technical Data Siren ASSIR24**

<b>ASSIR24</b>	
<b>Electrical</b>	
Data according to	EN 60669-1
Feed voltage	24 V AC/DC
Voltage tolerance range	± 15%
Power loss	2.4 VA
Voltage test AC	2.5 kV
Sound volume	105 dB
Operative temperature	-10 to +55 °C
Storage temperature	-25 to +70 °C
Degree of protection	IP20

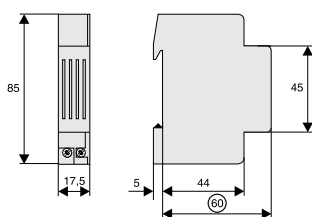
**Dimensions (mm)**

Description	Type Designation	Article No.	Units per package
-------------	------------------	-------------	-------------------

**Command and Signalling Devices RMQ Titan® xCommand**

- Complete units for front installation

**Push-button, flat, 1NO+1NC**

wa\_sg00912



spring-return, black	M22-D-S-K11	SET000001	1
spring-return, white	M22-D-W-K11	SET000002	1
spring-return, red	M22-D-R-K11	SET000003	1
spring-return, green	M22-D-G-K11	SET000004	1
spring-return, gelb	M22-D-Y-K11	SET000005	1
spring-return, blue	M22-D-B-K11	SET000006	1
stay-put, black	M22-DR-S-K11	SET000007	1
stay-put, white	M22-DR-W-K11	SET000008	1
stay-put, red	M22-DR-R-K11	SET000009	1
stay-put, green	M22-DR-G-K11	SET000010	1
stay-put, gelb	M22-DR-Y-K11	SET000011	1
stay-put, blue	M22-DR-B-K11	SET000012	1

**Push-button, flat, LED 230 V, 1NO+1NC**

wa\_sg00912



spring-return, white	M22-DL-W-K11-230-W	SET000013	1
spring-return, red	M22-DL-R-K11-230-R	SET000014	1
spring-return, green	M22-DL-G-K11-230-G	SET000015	1
spring-return, gelb	M22-DL-Y-K11-230-W	SET000016	1
spring-return, blue	M22-DL-B-K11-230-B	SET000017	1
stay-put, white	M22-DRL-W-K11-230-W	SET000018	1
stay-put, red	M22-DRL-R-K11-230-R	SET000019	1
stay-put, green	M22-DRL-G-K11-230-G	SET000020	1
stay-put, gelb	M22-DRL-Y-K11-230-W	SET000021	1
stay-put, blue	M22-DRL-B-K11-230-B	SET000022	1

**Indicator lamp, flat, LED 230 V**

wa\_sg00612



white	M22-L-W-230-W	SET000023	1
red	M22-L-R-230-R	SET000024	1
green	M22-L-G-230-G	SET000025	1
gelb	M22-L-Y-230-W	SET000026	1
blue	M22-L-B-230-B	SET000027	1

**Selector, 1NO+1NC**

wa\_sg00712



2 positions, spring-return	M22-WK-K11	SET000028	1
2 positions, stay-put	M22-WRK-K11	216519	1

**Key-operated switch, 1NO+1NC**

wa\_sg00812



2 positions, spring-return	M22-WS-K11	SET000029	1
2 positions, stay-put	M22-WRS-K11	216517	1



Description	Type Designation	Article No.	Units per package
-------------	------------------	-------------	-------------------

#### Double push-button, 1NO+1NC with LED

wa\_sg01012



Double push-button 1NO+1NC with LED	M22-DDL-GR-X1/X0/K11/230-W	216509	1
-------------------------------------	----------------------------	--------	---

#### Accessories RMQ Titan®

SG06410



DIN rail adapter	M22-IVS	216400	1
Contact element 1NO	M22-K10	216376	20
Contact element 1NC	M22-K01	216378	20

#### EMERGENCY SWITCH-OFF button, complete unit IP66

wa\_sg02911



Emergency switch-off button, 2NC, surface-mounted	M22-PV/KC02/IY	216524	1
---	----------------	--------	---

**Technical Data Command and Signalling Devices RMQ Titan® xCommand**

	Contact elements	LED elements <sup>1)</sup>	Luminous push-button Push-button
<b>General</b>			
Standards and regulations	IEC/EN 60947, VDE 0660		
Endurance, mechanical components	> 5 x 10 <sup>6</sup> switching op.	–	> 5 x 10 <sup>6</sup> switching op.
Operating frequency	≤ 3600 switching op./h	–	≤ 3600 switching op./h
Operating force	≤ 5 N	–	≤ 5 N
Operating torque (Screw-type terminals)	≤ 0.8 Nm	–	–
Degree of protection IEC/EN 60529	IP20	IP20	IP67, IP69K
Resistance to climatic conditions <sup>2)</sup>	Humidity and heat, constant, according to IEC 60068-2-78 Humidity and heat, periodic, according to IEC 60068-2-30		
Ambient temperature <sup>1)</sup> , open	-25 to +70 °C	-25 to +70 °C	-25 to +70 °C
Operation position	as required	as required	as required
Shock resistance according to IEC 60068-2-27, Shock duration 11 ms, half-sinusoidal	> 30 g	> 30 g	> 30 g
Terminal capacity			
solid	0.75 - 2.5 mm <sup>2</sup>	0.75 - 2.5 mm <sup>2</sup>	–
multi-wire	0.5 - 2.5 mm <sup>2</sup>	0.75 - 2.5 mm <sup>2</sup>	–
<b>Current paths</b>			
Rated peak withstand voltage	U <sub>imp</sub> 6000 V AC	6000 V AC	–
Rated insulation voltage	U <sub>i</sub> 500 V	500 V	–
Overvoltage category/Pollution degree	III/3	III/3	–
Circuit safety	H <sub>F</sub>		
at 24 V DC / 5 mA	< 10 <sup>-7</sup> failure rate, < 1 failure to 10 <sup>7</sup> switching operations	–	–
at 5 V DC / 1 mA	< 5 x 10 <sup>-6</sup> failure rate, < 1 failure to 5 x 10 <sup>6</sup> switching operations	–	–
Max. short-circuit protection			
Without fuse	PKZM0-10 / PLSM-B6	–	–
Fuse gG/gL	10 A	–	–
<b>Switching capacity</b>			
Rated operational current	I <sub>e</sub>		
AC-15			
115 V	6 A	–	–
120 V	6 A	–	–
400 V	4 A	–	–
500 V	2 A	–	–
DC-13			
24 V	3 A	–	–
42 V	1.7 A	–	–
60 V	1.2 A	–	–
110 V	0.8 A	–	–
220 V	0.3 A	–	–
Endurance, electrical components			
AC-15			
230 V / 0.5 A	1.6 x 10 <sup>6</sup> switching operations	–	–
230 V / 1 A	1 x 10 <sup>6</sup> switching operations	–	–
230 V / 3 A	0.7 x 10 <sup>6</sup> switching operations	–	–
DC-13			
12 V / 2.8 A	1.2 x 10 <sup>6</sup> switching operations	–	–

<sup>1)</sup> > 200 V AC / 60 Hz: -25 to +55 °C

<sup>2)</sup> Indoor and protected outdoor position

**Dimensions (mm)**

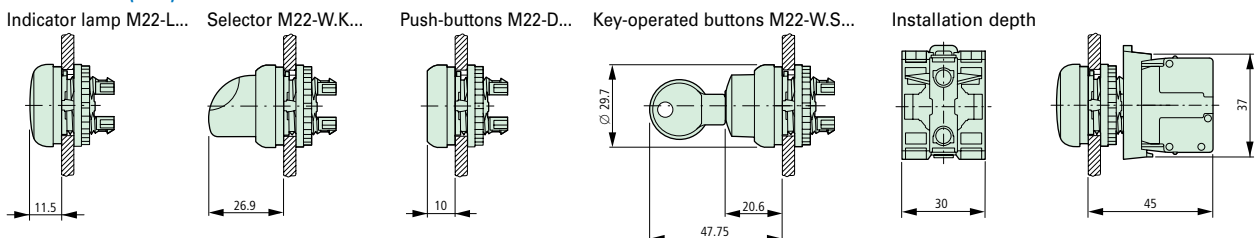

Description	Type Designation	Article No.	Units per package
-------------	------------------	-------------	-------------------

### Command and Signalling Devices LS-TITAN® xCommand

- NO, 1 NC

#### Position switch LS-11, IP66

wa\_sg03111



Description	Type Designation	Article No.	Units per package
Cap plunger head	LS-11	266109	10
Roller plunger	LS-11/P	266112	2
Spring-rod head, snap-action switch	LS-11S/S	266104	2
Roller lever	LS-11/L	266110	2
Rotary lever	LS-11/RL	266111	2
Adjustable roller lever	LS-11/RLA	266113	2
Actuating lever, snap-action switch	LS-11S/RR	266106	4

### Technical Data Command and Signalling Devices LS-TITAN® xCommand

		Position switch LS-11
<b>General</b>		
Standards and regulations		IEC/EN 60947
Resistance to climatic conditions		Humidity and heat, constant, according to IEC 60068-2-78 Humidity and heat, periodic, according to IEC 60068-2-30
Ambient temperature		-25 to +70 °C
Operation position		as required
Terminal capacity Cage-Clamp <sup>1)</sup>		
solid		1 x (0.5-2.5) mm <sup>2</sup>
fine wires with wire end sleeve according to DIN 46228		1 x (0.5-1.5) mm <sup>2</sup>
<b>Current paths/Switching capacity</b>		
Rated peak withstand voltage	$U_{imp}$	4000 V AC
Rated insulation voltage	$U_i$	500 V
Overtoltage category/Pollution degree		III/3
Circuit safety	$H_f$	
at 24 V DC / 5 mA		< 10 <sup>-7</sup> failure rate, < 1 failure to 10 <sup>7</sup> switching operations
at 5 V DC / 1 mA		< 5 x 10 <sup>-6</sup> failure rate, < 1 failure to 5 x 10 <sup>6</sup> switching operations
Rated operational current	$I_e$	
AC-15		
24 V		6 A
230/240 V		6 A
400/415 V		4 A
DC-13		
24 V		10 A
110 V		1 A
220 V		0.5 A
Line frequency		max. 400 Hz
Short-circuit resistance when closed (IEC/EN 60947-5-1)		
Without fuse		PKZM0-10 / PLSM-B6
max. Fuse gG/gL		10 A
Short-circuit current strength IEC/EN 60947-5-1, max. Fuse gG/gL		6 A
<b>Mechanical specifications</b>		
Endurance		
Standard-action switch		8 x 10 <sup>6</sup> switching operations
Snap-action switch		8 x 10 <sup>6</sup> switching operations
Contact temperature of the actuating roller		≤ 100 °C
Shock resistance (half-sinusoidal shock 20 ms)		
Standard-action switch		25 g
Snap-action switch		2 g
Basic device		–
Operating frequency		≤ 6000 switching operations/h

<sup>1)</sup> Cage-Clamp is a registered trademark of Wago Kontakttechnik, D-32423 Minden

**Dimensions (without actuation element) in mm**

Position switch LS-11...

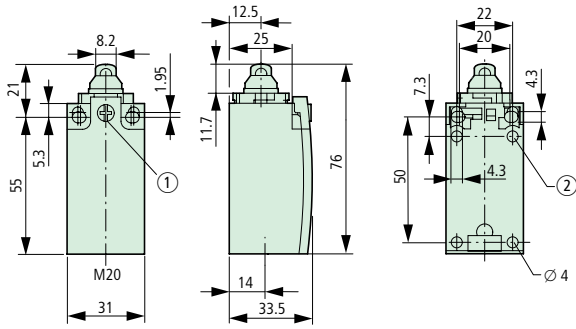

Rated current (A)	Rated power (kW)	Auxiliary contact	Type Designation	Article No.	Units per package
-------------------	------------------	-------------------	------------------	-------------	-------------------

### Contactors DILM

#### Control Voltage 230 V 50 Hz, 240 V 60 Hz

7	3	1NC	DILM7-10(230V50HZ)	276550	1
7	3	1NC	DILM7-01(230V50HZ)	276585	1
6	4	1NC	DILM9-10(230V50HZ)	276690	1
6	4	1NC	DILM9-01(230V50HZ)	276725	1
12	5.5	1NC	DILM12-10(230V50HZ)	276830	1
12	5.5	1NC	DILM12-01(230V50HZ)	276865	1
17	7.5	1NC	DILM17-10(230V50HZ)	277004	1
17	7.5	1NC	DILM17-01(230V50HZ)	277036	1
25	11	1NC	DILM25-10(230V50HZ)	277132	1
25	11	1NC	DILM25-01(230V50HZ)	277164	1
32	15	1NC	DILM32-10(230V50HZ)	277260	1
32	15	1NC	DILM32-01(230V50HZ)	277292	1
40	18.5	–	DILM40(230V50HZ)	277766	1
50	22	–	DILM50(230V50HZ)	277830	1
65	30	–	DILM65(230V50HZ)	277894	1

wa\_sg00111



#### Control Voltage 24 VDC

7	3	1NC	DILM7-10(24VDC)	276565	1
7	3	1NC	DILM7-01(24VDC)	276600	1
6	4	1NC	DILM9-10(24VDC)	276705	1
6	4	1NC	DILM9-01(24VDC)	276740	1
12	5.5	1NC	DILM12-10(24VDC)	276845	1
12	5.5	1NC	DILM12-01(24VDC)	276880	1
17	7.5	1NC	DILM17-10(RDC24)	277018	1
17	7.5	1NC	DILM17-01(RDC24)	277050	1
25	11	1NC	DILM25-10(RDC24)	277146	1
25	11	1NC	DILM25-01(RDC24)	277178	1
32	15	1NC	DILM32-10(RDC24)	277274	1
32	15	1NC	DILM32-01(RDC24)	277306	1
40	18.5	–	DILM40(RDC24)	277780	1
50	22	–	DILM50(RDC24)	277844	1
65	30	–	DILM65(RDC24)	277908	1

wa\_sg00111



Overload release setting range (A)	Type Designation	Article No.	Units per package
------------------------------------	------------------	-------------	-------------------

### Motor-protective Relay ZB

#### Suitable for DILM7 to DILM32

0.1 - 0.16	ZB12-0.16	278431	1
0.16 - 0.25	ZB12-0.24	278432	1
0.25 - 0.4	ZB12-0.4	278433	1
0.4 - 0.63	ZB12-0.6	278434	1
0.63 - 1	ZB12-1	278435	1
1 - 1.6	ZB12-1.6	278436	1
1.6 - 2.5	ZB12-2.4	278437	1
2.5 - 4	ZB12-4	278438	1
4 - 6,3	ZB12-6	278439	1
6.3 - 10	ZB12-10	278440	1
10 - 12	ZB12-12	278441	1
12 - 16	ZB32-16	278452	1
16 - 24	ZB32-24	278453	1
24 - 32	ZB32-32	278454	1

wa\_sg17604



wa\_sg17704



Overload release setting range (A)	Type Designation	Article No.	Units per package
<b>Suitable for DILM40 to DILM65</b>			
6 - 10	ZB65-10	278455	1
10 - 16	ZB65-16	278456	1
16 - 24	ZB65-24	278457	1
24 - 40	ZB65-40	278458	1
40 - 57	ZB65-57	278459	1
50 - 65	ZB65-65	278460	1

wa\_sg17404



NO	NC	Type Designation	Article No.	Units per package
<b>Auxiliary Switch moduless DILA-XHI</b>				
<b>Suitable for DILM7 to DILM32</b>				
2	—	DILA-XHI20	276422	5
1	1	DILA-XHI11	276421	5
4	—	DILA-XHI40	276428	5
3	1	DILA-XHI31	276427	5
2	2	DILA-XHI22	276426	5

wa\_sg03011



NO	NC	Type Designation	Article No.	Units per package
<b>Auxiliary Switch moduless DILM150-XHI</b>				
<b>Suitable for DILM40 to DILM65</b>				
2	—	DILM150-XHI20	277945	5
1	1	DILM150-XHI11	277946	5
4	—	DILM150-XHI40	277948	5
3	1	DILM150-XHI31	277949	5
2	2	DILM150-XHI22	277950	5

### Technical Data Contactors xStart

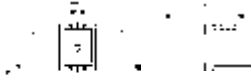
		DILM, DILA, ZB
<b>General</b>		
Standards and regulations		IEC/EN 60947, VDE 0660, UL, CSA
Endurance, mechanical components		
AC operated		10 x 10 <sup>6</sup> switching operations
DC operated		10 x 10 <sup>6</sup> switching operations
Switching frequency, mechanical components		
AC operated		9000 switching operations/h
DC operated		9000 switching operations/h
Resistance to climatic conditions		Humidity and heat, constant, according to IEC 60068-2-78 Humidity and heat, periodic, according to IEC 60068-2-30
Ambient temperature		
open		-25 to +60 °C
hermetically enclosed		-25 to +40 °C
storage		-40 to +80 °C
Mounting position AC and DC operated		
Shock resistance (half-sinusoidal shock 10 ms) (IEC/EN 60068-2-27)		
Main switching elements NO		10 g
Auxiliary switching elements NO		7 g
Auxiliary switching elements NC		5 g
Degree of protection		IP20
Protection against accidental contact in case of vertical actuation from the front		finger and hand touch safe according to DGUV VS3, EN 50274
<b>Main current paths</b>		
Rated peak withstand voltage	$U_{imp}$	8000 V AC
Rated insulation voltage	$U_i$	690 V
Overtoltage category/Pollution degree		III/3
Rated operational voltage	$U_e$	690 V
Safe separation according to VDE 0106 Part 101 and Part 101/A1		
between coil and contacts		400 V AC
between the contacts		400 V AC
Making capacity $\cos\phi$ according to IEC/EN 60947 to 690 V		112 A

### Dimensions (mm)

Contactors DILM7-DILM12

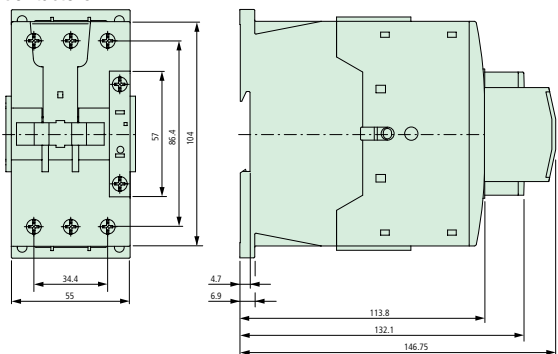

Contactors DILM17-DILM32

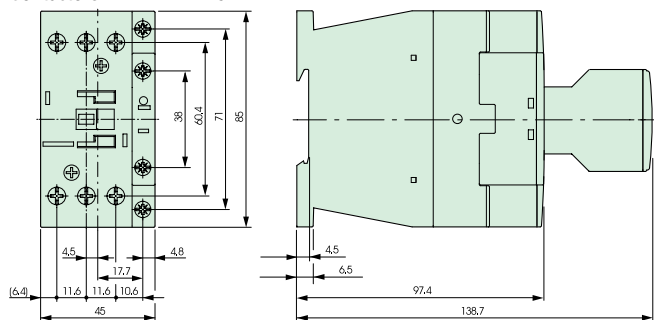

Contactors DILM40-DILM65

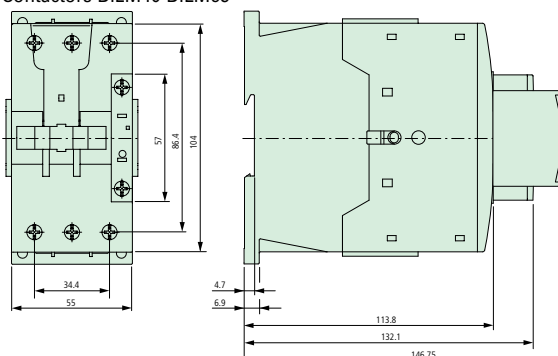

Motor-protective Relay ZB12, ZB32

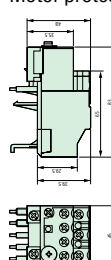

SG13113

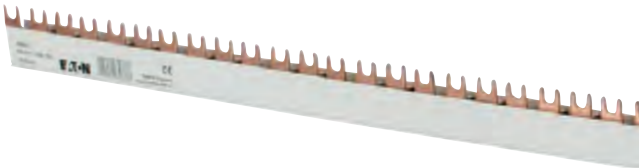

sg03515

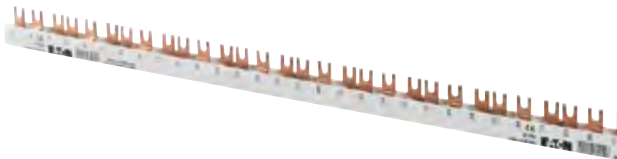

wa\_sg03511



Wa\_sg02902





SG13113

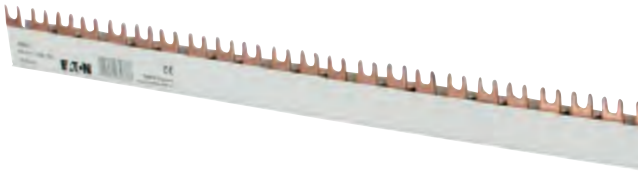

## Description

Busbar System xEffect is the modular design system for busbars. xEffect busbars are available as yard goods with 1, 2 or 3 poles. Now, there is a special feature: each bar can easily be extended by one-pole bar as you like. The additional pole can be added completely without tools by easy clamping technique. The lugs or forks in the xEffect bars - available in 10 and 16 mm<sup>2</sup> and all common distances - can be broken out at a predetermined breaking point. There is actually no more flexibility available.

### Busbar System xEffect saves time and material

The yard good can be cut with a saw of course. However, there is no need neither for deburring nor for cutting the conductor. Just cut to the required dimension and close with the fitting end cap -ready! The end caps have also breakable edges, which enable further connecting of the busbar System xEffect. By overlapping assembly, doubling the cross section can be achieved.

### Busbar System xEffect in use

Busbar System xEffect is especially well suited for solving flexible busbar applications rack-mounted models in series. Fork-pin combinations for 1+N-applications can be realized by individual combinations - for this also the one-pole version with blue isolation is available besides the one with grey isolation. Even different cross sections can be combined in this case.

Accessories, such as feeder terminals and self adhesive phase marking labels will complete the comfortable total package. Existing contact prevention caps can be used.

### Busbar System xEffect at a glance:

- Yard goods can be cut
- No cutting back of copper required
- No deburring required
- Almost no waste during cutting
- End caps available with 1- to 4-poles, end caps can be broken out for further extensions
- 4-pole end cap molded in pairs (left and right)
- Overlapping rail extension possible

- Rails can be extended on demand by 1-pole rails (plug-in technology)
- All step distances
- 10 and 16 mm<sup>2</sup>
- Fork and stud
- Lugs can be broken out at any predetermined breaking point
- Self adhesive phase indication labels available
- Contact preventing caps (ZV-BS-G) can be used
- Simple, flexible handling
- All assembly requirements can be covered by the busbar System xEffect
- Low storage space requirements due to modular system
- Less time consuming (no deburring, no cutting back)
- Individual and self configurable
- Fork-pin combination for 1+N application possible, feeding through rail (terminal clamp) not possible.
- Protected technology

Description	Step Distance (mm)	Cu-factor	Type Designation	Article No.	Units per package
-------------	--------------------	-----------	------------------	-------------	-------------------

**For MCBs, RCCBs, RCBOs, SPDs**

- delivered without end caps

SG13113



**10 mm<sup>2</sup>, Rated current 63 A**

1-phase	17.8	0.22	BB-EVF-10/1P-1MU	168826	10
	27	0.24	BB-EVF-10/1P-1,5MU	168830	10
	36	0.24	BB-EVF-10/1P-2MU	168834	10
2-phases	17.8	0.31	BB-EVF-10/2P-1MU	168838	10
	27	0.36	BB-EVF-10/2P-1,5MU	168840	10
3-phases	17.8	0.46	BB-EVF-10/3P-1MU	168842	10
	27	0.58	BB-EVF-10/3P-1,5MU	168844	10
	36	0.56	BB-EVF-10/3P-2MU	168850	10
3-phases + AUX	3x17.8+1x9	0.58	BB-EVF-10/3P-1MU/AUX	168846	10
	3x17.8+2x9	0.57	BB-EVF-10/3P-1MU/2AUX	168848	10
Neutral	17.8	0.22	BB-EVF-10/N-1MU	168828	10
	27	0.24	BB-EVF-10/N-1,5MU	168832	10
	36	0.24	BB-EVF-10/N-2MU	168836	10

SG13213



**16 mm<sup>2</sup>, Rated current 80 A**

1-phase	17.8	0.33	BB-EVF-16/1P-1MU	168827	10
	27	0.36	BB-EVF-16/1P-1,5MU	168831	10
	36	0.32	BB-EVF-16/1P-2MU	168835	10
2-phases	17.8	0.46	BB-EVF-16/2P-1MU	168839	10
	27	0.54	BB-EVF-16/2P-1,5MU	168841	10
3-phases	17.8	0.69	BB-EVF-16/3P-1MU	168843	10
	27	0.87	BB-EVF-16/3P-1,5MU	168845	10
	36	0.84	BB-EVF-16/3P-2MU	168851	10
3-phases + AUX	3x17.8+1x9	0.87	BB-EVF-16/3P-1MU/AUX	168847	10
	3x17.8+2x9	0.86	BB-EVF-16/3P-1MU/2AUX	168849	10
Neutral	17.8	0.33	BB-EVF-16/N-1MU	168829	10
	27	0.36	BB-EVF-16/N-1,5MU	168833	10
	36	0.32	BB-EVF-16/N-2MU	168837	10

SG13613



Description	Step Distance (mm)	Cu-factor	Type Designation	Article No.	Units per package
-------------	--------------------	-----------	------------------	-------------	-------------------

### For MCBs, RCCBs, RCBOs, SPDs

- delivered without end caps

SG13113



#### 10 mm<sup>2</sup>, Rated current 63 A

1-phase	17.8	0.22	BB-EVP-10/1P-1MU	168852	10
	27	0.24	BB-EVP-10/1P-1,5MU	168856	10
	36	0.24	BB-EVP-10/1P-2MU	168860	10
2-phases	17.8	0.31	BB-EVP-10/2P-1MU	168864	10
	27	0.36	BB-EVP-10/2P-1,5MU	168866	10
3-phases	17.8	0.46	BB-EVP-10/3P-1MU	168868	10
	27	0.58	BB-EVP-10/3P-1,5MU	168870	10
	36	0.56	BB-EVP-10/3P-2MU	168876	10
3-phases + AUX	3x17.8+1x9	0.58	BB-EVP-10/3P-1MU/AUX	168872	10
	3x17.8+2x9	0.57	BB-EVP-10/3P-1MU/2AUX	168874	10
Neutral	17.8	0.22	BB-EVP-10/N-1MU	168854	10
	27	0.24	BB-EVP-10/N-1,5MU	168858	10
	36	0.24	BB-EVP-10/N-2MU	168862	10

SG13413



SG13213



#### 16 mm<sup>2</sup>, Rated current 80 A

1-phase	17.8	0.33	BB-EVP-16/1P-1MU	168853	10
	27	0.36	BB-EVP-16/1P-1,5MU	168857	10
	36	0.32	BB-EVP-16/1P-2MU	168861	10
2-phases	17.8	0.46	BB-EVP-16/2P-1MU	168865	10
	27	0.54	BB-EVP-16/2P-1,5MU	168867	10
3-phases	17.8	0.69	BB-EVP-16/3P-1MU	168869	10
	27	0.87	BB-EVP-16/3P-1,5MU	168871	10
	36	0.84	BB-EVP-16/3P-2MU	168877	10
3-phases + AUX	3x17.8+1x9	0.87	BB-EVP-16/3P-1MU/AUX	168873	10
	3x17.8+2x9	0.86	BB-EVP-16/3P-1MU/2AUX	168875	10
Neutral	17.8	0.33	BB-EVP-16/N-1MU	168855	10
	27	0.36	BB-EVP-16/N-1,5MU	168859	10
	36	0.32	BB-EVP-16/N-2 MU	168863	10

SG13613

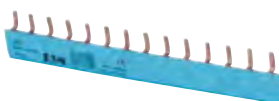

### Accessories

#### End Caps BB-EV-EC

wa\_sg05612



1-phase	-	-	BB-EV-EC/1P	168878	40
2+3-phases	-	-	BB-EV-EC/2-3P	168823	40
4-phases	-	-	BB-EV-EC/4P	168824	20
Neutral	-	-	BB-EV-EC/N	168879	20

#### Terminal BB-EV-MU/35

wa\_sg05312



-	-	0.04	BB-EV-MU/35	168825	3
---	---	------	-------------	--------	---

#### Sticker Phase Sequence

SG08713

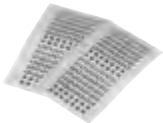

-	-	-	BB-S-PS	169831	5
---	---	---	---------	--------	---

#### Busbar Tag Shrouds ZV-BS-G

SG05706



-	-	-	ZV-BS-G	104903	10/600
---	---	---	---------	--------	--------

**Technical Data**

		<b>BB-EV.</b>
<b>General</b>		
Heat deflection temperature		≥ 80°C UL94 V0
Standards		EN 60947-1:2007 / IEC 60947-1:2007 / IEC 60999:2000
Climate stability		according to DIN EN 60068
Insulation coordination		Overvoltage category III / Pollution degree 2
<b>Electrical</b>		
Impulse voltage strenght		≥ 4.5 kV
Min. air distance		>5.5 mm
Min. creeping distance		>5 mm
Max. operating voltage		690 V AC/DC 1,000 V DC 1-pole only
Max. busbar current	I <sub>s</sub> /Phase	
10 mm <sup>2</sup>		63 A
16 mm <sup>2</sup>		80 A
Protection class		IP20
Short circuit rating	I <sub>cc</sub>	25 kA - NH3 355A, gC500V JM
Dielectric strenght		PC - ABS >32 kV / mm

**Assembly instruction:**

**Cutting**

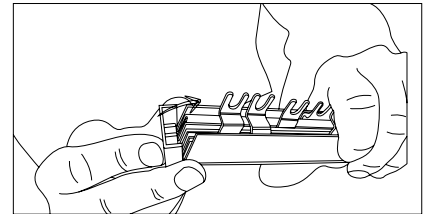
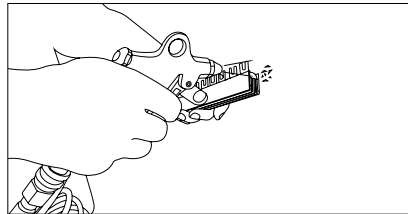
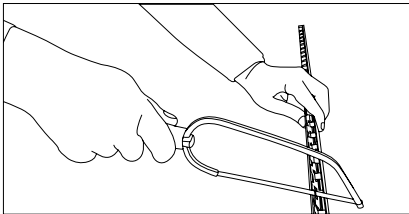

**Mounting of an extension busbar**

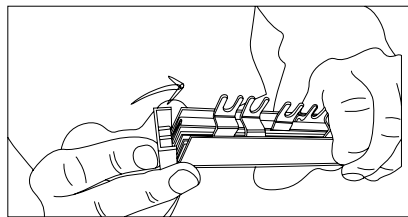
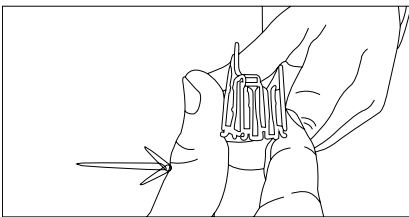
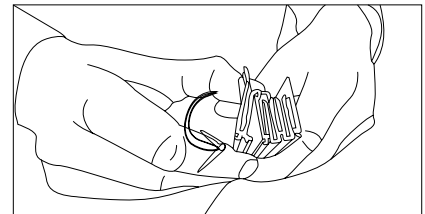
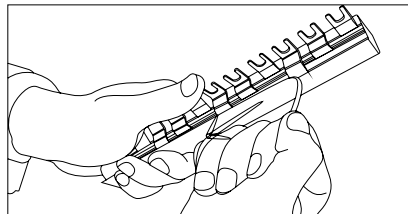
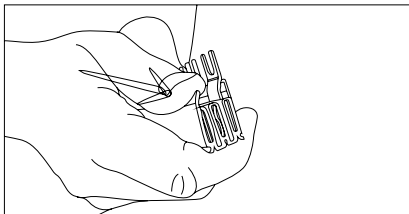

**Overlapping mounting or further connection, resp.**

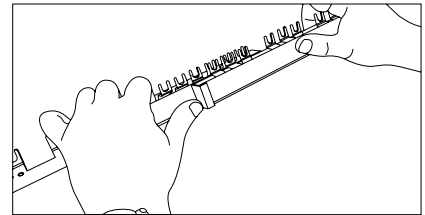
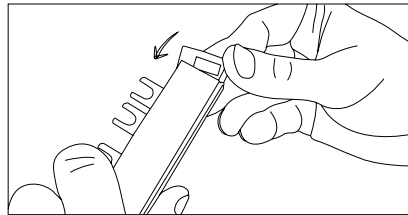
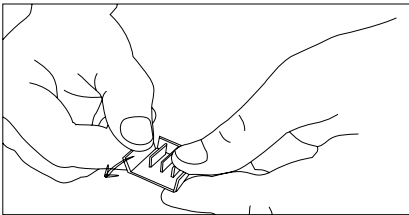

**Breacking out of connection lugs**

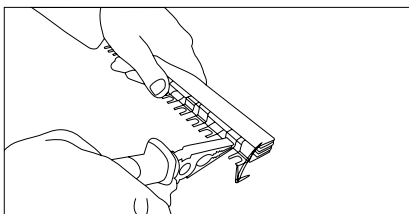

**Sticking on phase marking**

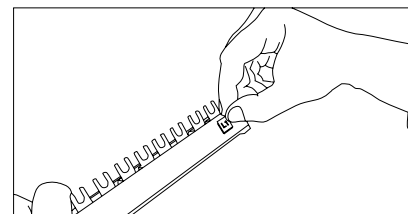

### Plug-in busbar System 50 A, 80 A ZV

for PLS., PKN., PFIM, PFHM (with Auxiliary Switch)

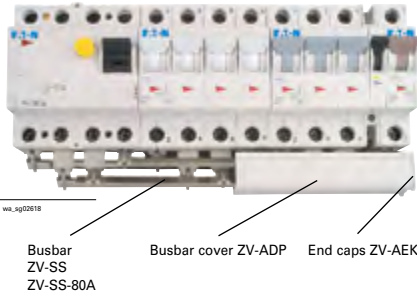

Description	Cu-factor	Type Designation	Article No.	Units per package
-------------	-----------	------------------	-------------	-------------------

#### Connection Angle L1, N



Same connection angle ZV-L1/N (-80A), for L1 and N, turned by 180°

50 A				
10 units	0.005	ZV-L1/N-10	263941	10 / 600
36 units	0.005	ZV-L1/N-36	263942	36 / 2160
100 units	0.005	ZV-L1/N-100	263943	100 / 3000
80 A				
10 units	0.005	ZV-L1/N-80A-10	263950	10 / 600
36 units	0.005	ZV-L1/N-80A-36	263951	36 / 2160
100 units	0.005	ZV-L1/N-80A-100	263952	100 / 3000

#### Connection Angle L2, L3



Same connection angle ZV-L2/L3(-80A), for L2 and L3, turned by 180°

50 A				
10 units	0.007	ZV-L2/L3-10	263944	10 / 600
36 units	0.007	ZV-L2/L3-36	263945	36 / 2160
100 units	0.007	ZV-L2/L3-100	263946	100 / 3000
80 A				
10 units	0.007	ZV-L2/L3-80A-10	263953	10 / 600
36 units	0.007	ZV-L2/L3-80A-36	263954	36 / 2160
100 units	0.007	ZV-L2/L3-80A-100	263955	100 / 3000

#### Connection Angle N (0.5 MU) for PLSM



Same connection angle ZV-N-05TE for N 50 and 80 A busbar

50 A				
10 units	0.005	ZV-N-05TE-10	263947	10 / 600
36 units	0.005	ZV-N-05TE-36	263948	36 / 2160
80 A				
100 units	0.005	ZV-N-05TE-100	263949	100 / 3000

#### Busbar 1m

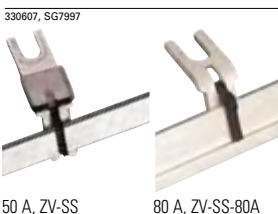

50 A, ZV-SS      80 A, ZV-SS-80A

50 A				
	0.143	ZV-SS	263956	1 / 10
80 A				
	0.230	ZV-SS-80A	263957	1 / 10

Description	Type Designation	Article No.	Units per package
<b>Accessories</b>			
Busbar cover 1m, for 50+80 A	ZV-ADP	263958	1 / 10
End caps for busbar cover	ZV-AEK	263959	10 / 600
Power feed block 35/50mm <sup>2</sup>	Z-D80	248269	12 / 120

### Description Plug-in busbar System 50 A, 80 A ZV

- Any combinations of switchgear with or without auxiliary switch possible
- Low number of components, 2 angle types per busbar cross-section for three-phases AC
- Same busbar cover and end caps for ZV-SS and ZV-SS-80A
- Short-circuit withstand strength and dielectric properties tested according to IEC/EN 60439-1

### Technical Data

		ZV
<b>Electrical</b>		
Rated operational voltage		240/415 VA C
Rated frequency		50/60 Hz, DC
Rated voltage		690 V (at Pollution degree 2) 440 V (at Pollution degree 3)
Overvoltage category		III
Rated peak withstand voltage	$U_{imp}$	4 kV
Rated current		
ZV-./., ZV-SS		50 A
ZV-./.-80A, ZV-SS-80A		80 A
ZV.-N-05TE		32 A
Conditional rated short circuit current		
AC with 125 A gG		
ZV-./., ZV-SS		50 kA
ZV-./.-80A, ZV-SS-80A		50 kA
ZV.-N-05TE		10 kA
AC with 160 A gG		
ZV-./., ZV-SS		–
ZV-./.-80A, ZV-SS-80A		50 kA
ZV.-N-05TE		10 kA
DC with 160 A gG		
ZV-./., ZV-SS		10 kA
ZV-./.-80A, ZV-SS-80A		10 kA
ZV.-N-05TE		–
<b>Mechanical</b>		
Busbar cross section		
ZV-SS		16 mm <sup>2</sup> Cu
ZV-SS-80A		25 mm <sup>2</sup> Cu
Busbar length		1 m
Degree of protection mounted with busbar cover and end caps		IP20
Pollution degree		2 (3)
Air gap		≥ 3.2 mm
Minimum creepage distance		≥ 7 mm

### Connection diagram

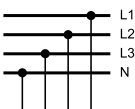

### Dimensions (mm) 50 A

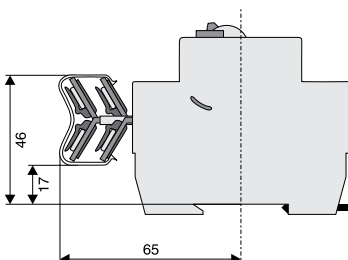

### Dimensions (mm) 80 A

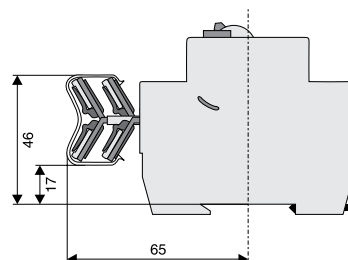

Description	Cu-factor	Type Designation	Article No.	Units per package
-------------	-----------	------------------	-------------	-------------------

**Busbar Block (Fork) Z-GV**

- for PXL, PXX, PXF, PLS., PKN., PFIM, PFHM, Z-SLS/D01

**Busbar Block (Fork) Z-GV**

- delivered with end caps

sg03515

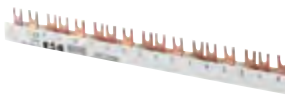

**16 mm<sup>2</sup> - Rated current 80 A**

1-phase 16x	0.095	Z-GV-16/1P-1MU/16	271074	50
2-phases 8x	0.187	Z-GV-16/1P+N-2MU/16	271075	20
4-phases 4x	0.444	Z-GV-16/3P+N-4MU/16	271078	15

**Busbar Block (Fork) Z-GV, 1 Meter**

- delivered without end caps

sg03515

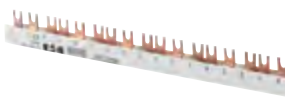

**10 mm<sup>2</sup> - Rated current 63 A**

1-phase	0.408	Z-GV-10/1P-1MU	270339	50
3-phases	0.739	Z-GV-10/3P-3MU	271060	20
3-phases	0.739	Z-GV-10/3P-4MU	271080	20
End cap 1-phase		Z-V-AK/1P	104905	10 / 600
End cap 2+3-phases		BB-EC/2+3P	120805	10 / 600

**16 mm<sup>2</sup> - Rated current 80 A**

1-phase	0.470	Z-GV-16/1P-1MU	271061	50
1-phase + Auxiliary Switch	0.470	Z-GV-16/1P+HS	271062	50
2-phases	0.657	Z-GV-16/1P+N-2MU	271063	20
3-phases	1.042	Z-GV-16/3P-3MU	271064	20
3-phases + Auxiliary Switch	0.998	Z-GV-16/3P+HS	271065	20
4-phases	1.465	Z-GV-16/3P+N-4MU	271066	15
4-phases	1.522	Z-GV-16/3P+3N-6MU	263142	15
4-phases	1.050	Z-GV-16/PKPX/4PHAS	116882	10
End cap 1-phase		Z-V-AK/1P	104905	10 / 600
End cap 2+3-phases		BB-EC/2+3P	120805	10 / 600
End cap 4-phases		Z-V-AK/4P	264931	10 / 600

Description	Type Designation	Article No.	Units per package
-------------	------------------	-------------	-------------------

**Accessories**

**Busbar Tag Shrouds for busbar, yellow ZV-BS-G**

SG05705



Finger and hand touch safe	ZV-BS-G	104903	10 / 600
----------------------------	---------	--------	----------

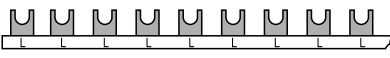
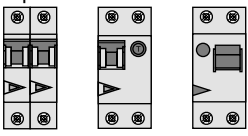
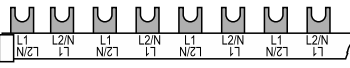
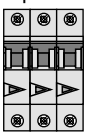
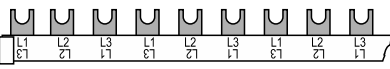
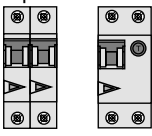
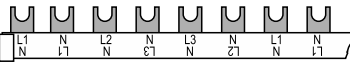
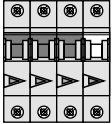
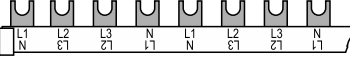
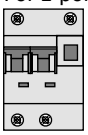
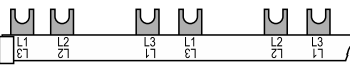
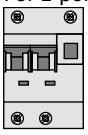
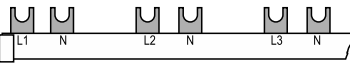
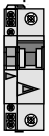
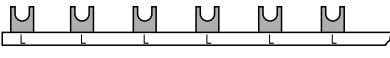
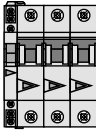
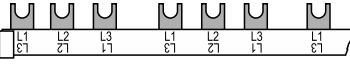

### Description of the Busbar Block (Fork) Z-GV

Devices to busbar	Pcs. of the devices	End caps	Type
<p>1-phase</p> 	<p>x57 x57 x16</p>	<p>Z-V- AK/1P</p> 	<p>Z-GV-10/1P-1TE Z-GV-16/1P-1TE Z-GV-16/1P-1TE/16</p>
<p>2-phases</p> 	<p>x28 x8</p>	<p>Z-AK- 16/2+3P</p> 	<p>Z-GV-16/1P+N-2TE Z-GV-16/1P+N-2TE/16</p>
<p>3-phases</p> 	<p>x19 x19 x2 x5</p>	<p>Z-AK- 10/2+3P Z-AK- 16/2+3P</p> 	<p>Z-GV-10/3P-3TE Z-GV-16/3P-3TE Z-GV-16/3P-3TE/8 Z-GV-16/3P-3TE/16</p>
<p>4-phases</p> 	<p>x27</p>	<p>Z-AK- 16/4P</p> 	<p>Z-GV-16/3P+3N-6TE</p>
	<p>x14 x4</p>	<p>Z-AK- 16/4P</p> 	<p>Z-GV-16/3P+N-4TE Z-GV-16/3P+N-4TE/16</p>
<p>For 2-pole Combined RCD/MCB Device, 3-phases</p> 	<p>x18 x6</p>	<p>Z-AK- 10/2+3P</p> 	<p>Z-GV-10/3P-4TE Z-GV-10/3P-4TE/17</p>
<p>For 2-pole Combined RCD/MCB Device, 4-phases</p> 	<p>x18</p>	<p>Z-V-AK/ 4P</p> 	<p>Z-GV-16/PKPX/4PHAS</p>
<p>1-phase + Auxiliary Switch</p> 	<p>x38</p>	<p>Z-V- AK/1P</p> 	<p>Z-GV-16/1P+HS</p>
<p>3-phases + Auxiliary Switch</p> 	<p>x16</p>	<p>Z-AK- 16/2+3P</p> 	<p>Z-GV-16/3P+HS</p>

**Description Busbar Block 10mm<sup>2</sup>, 16mm<sup>2</sup> (Fork) Z-GV**

- Length 1m
- Delivered without end caps. Please order separately.
- Short version (/17, /16, /8) delivered with end caps

**Technical Data**

	<b>Z-GV</b>
<b>Electrical</b>	
Rated voltage	240/415 V, 50/60 Hz
Rated current	
10 mm <sup>2</sup>	63 A
16 mm <sup>2</sup>	80 A
Short-circuit current strength	25 kA
<b>Mechanical</b>	
Busbar cross section	10 and 16 mm <sup>2</sup> Cu
Step distance	17.8 mm
Z-GV-16-P+HS	17.8/27 mm

**Connection diagram**

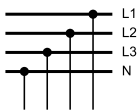

**Dimensions (mm)**

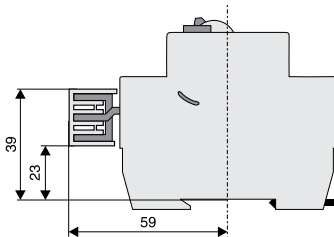

# 1.102 Busbar Systems

## Busbar Block (Fork) GVK

xPole

WA\_REN\_SG\_01922\_L, WA\_REN\_SG\_01322\_R, WA\_REN\_SG\_01522\_C

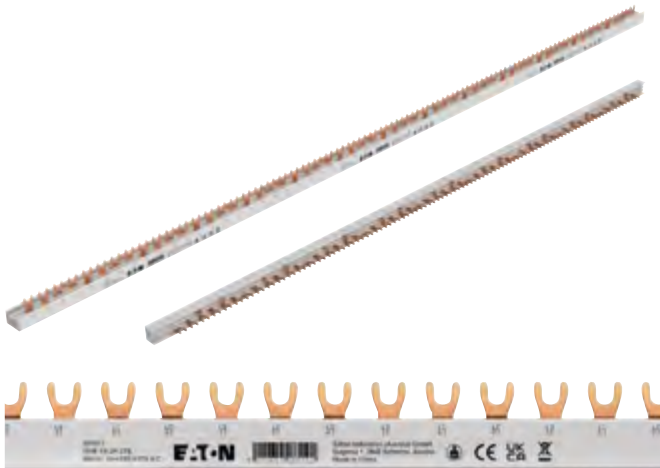

### Description

- Available in 10 and 16 mm<sup>2</sup> cross section
- Fork type
- 3- to 4-phases end caps available as accessories
- End caps must be ordered separately
- Comes in 1 meter length
- Busbar can be cut to desired length

Description	Cu-factor	Type Designation	Article No.	Units per package
-------------	-----------	------------------	-------------	-------------------

**Busbar Block (Fork) GVK**

- delivered without end caps
- comes in 1 meter length
- can be cut to length

**10 mm<sup>2</sup> - Rated current 63 A**

WA\_REN\_SG\_01922\_L



3-phases	0.350	GVK-10/3P-3TE	501073	20
----------	-------	---------------	--------	----

**16 mm<sup>2</sup> - Rated current 80 A**

3-phases	0.523	GVK-16/3P-3TE	501071	20
4-phases	0.660	GVK-16/3P+N-4TE	501074	15
4-phases	0.610	GVK-16/3P+3N-6TE	501072	15

**Accessories**

Description	Type Designation	Article No.	Units per package
-------------	------------------	-------------	-------------------

WA\_REN\_SG\_00822\_L



End cap 3-Phases for 10 mm <sup>2</sup>	EK-3/10-EVGK-GVK	501076	10 / 5000
End cap 3-Phases for 16 mm <sup>2</sup>	EK-3/16-EVGK-GVK	501077	10 / 5000
End cap 4-Phases for 16 mm <sup>2</sup>	EK-3N/16-EVGK-GVK	501078	10 / 5000

Description	Type Designation	Article No.	Units per package
-------------	------------------	-------------	-------------------

**Accessories**

**Busbar Tag Shrouds for busbar, yellow ZV-BS-G**

SG05705



Finger and hand touch safe	ZV-BS-G	104903	10 / 600
----------------------------	---------	--------	----------

### Description Busbar Block 10mm<sup>2</sup>, 16mm<sup>2</sup> (Fork) GVK

- GVK busbars can be cut to length
- Endcaps are not included and should be ordered separately

### Technical Data

GVK	
<b>General</b>	
Standards	DIN EN 61439-1:2021-10 / DIN EN 61439-6:2013-06 IEC 664 / IEC 60895-2-12 / VDE 0110 / DIN EN 60754-1
Climate stability	according to IEC 68-2
Overtoltage category	III
Pollution Degree	2
Busbar Material	E-Cu-ETP
Isolation Material	PC-ABS
Endcap Material	PC-ABS
Touch protection Material	PP
<b>Electrical</b>	
Rated operating voltage	240/415 V AC
Rated current	
10 mm <sup>2</sup>	63 A
16 mm <sup>2</sup>	80 A
Short-circuit current strength	25 kA /100 A gl
Disruptive Strength	36 kV/mm
Surge Voltage	$U_{imp}$ 4 kV
<b>Mechanical</b>	
Busbar cross section	10 and 16 mm <sup>2</sup>
Step distance	17.8 mm

### Feeding

Side Feeding

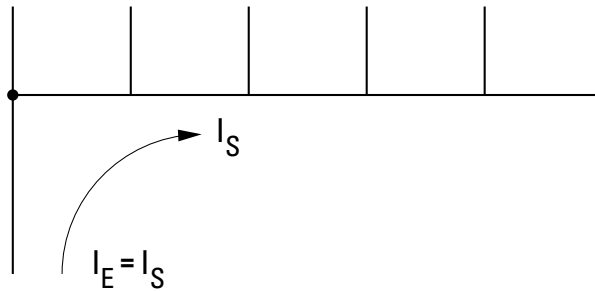

Central Feeding

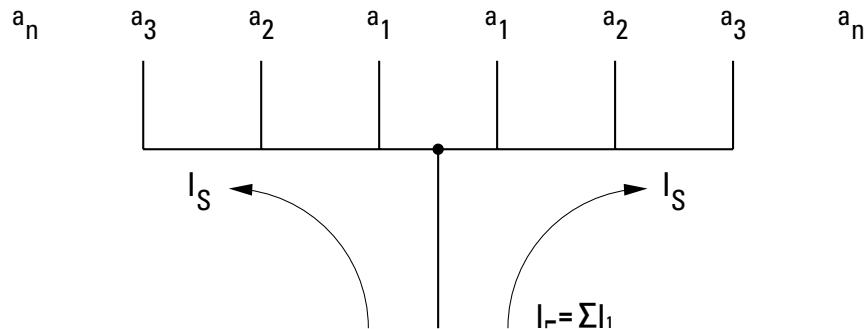

Using central supply feeding you must be sure that the sum of the output current depending on  $a_1 \dots a_n$  of each busbar part is not greater than the above max. busbar current  $I_s$  / phase

Connection diagram

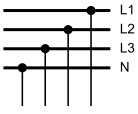

Description Graphics

Devices to busbar	Pcs. of the devices	End caps		Type
<p>3-phases</p>	<p>x19</p> <p>x19</p>	<p>EK-3/10-EVGK-GVK</p> <p>EK-3/16-EVGK-GVK</p>		<p>GVK-10/3P-3TE</p> <p>GVK-16/3P-3TE</p>
<p>2-phases (3P + 3N)</p>	<p>x27</p>	<p>EK-3N/16-EVGK-GVK</p>		<p>GVK-16/3P+3N-6TE</p>
<p>4-phases</p>	<p>x14</p>	<p>EK-3N/16-EVGK-GVK</p>		<p>GVK-16/3P+N-4TE</p>

Dimensions (mm)

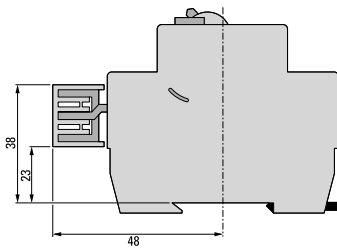

### End Cap dimensions (mm)

EK-3/10-EVGK-GVK

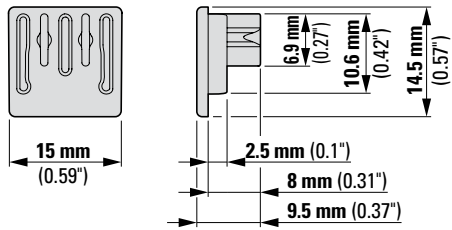

EK-3/16-EVGK-GVK

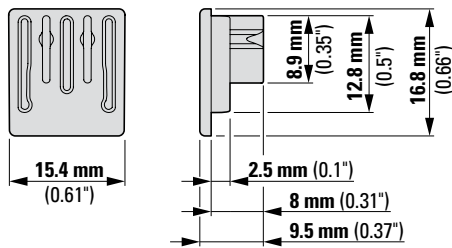

EK-3N/16-EVGK-GVK

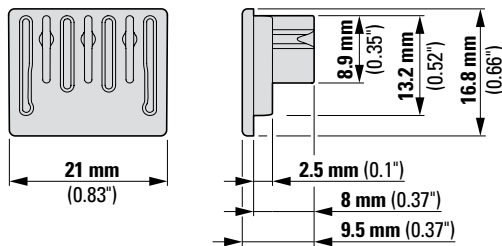

**Busbar dimensions (mm)**

GVK-10/3P-3TE

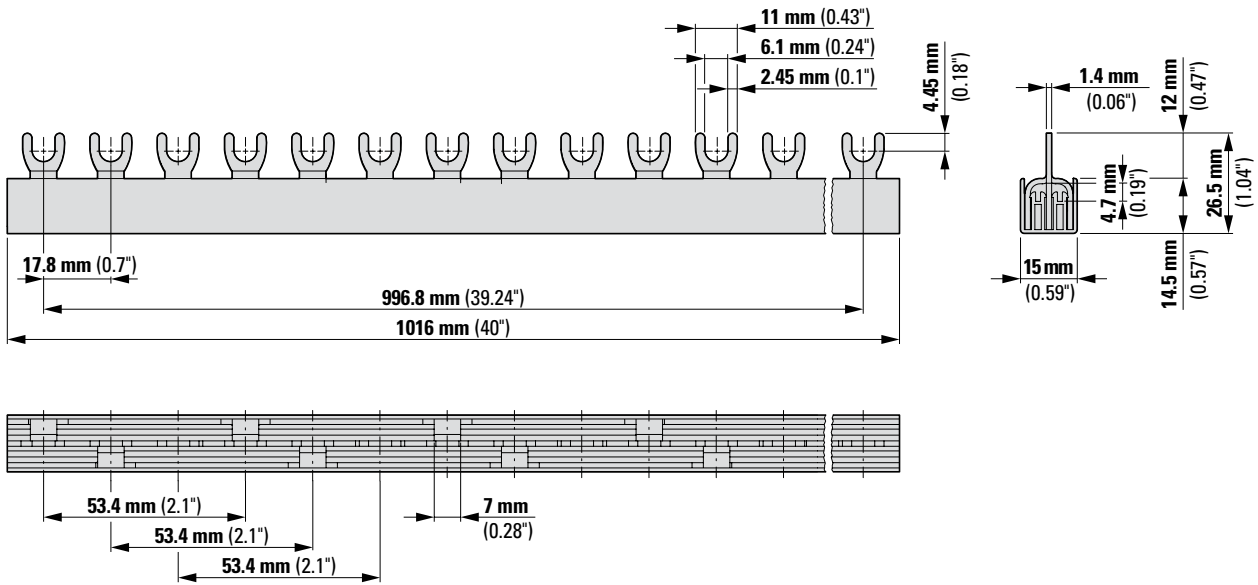

GVK-16/3P-3TE

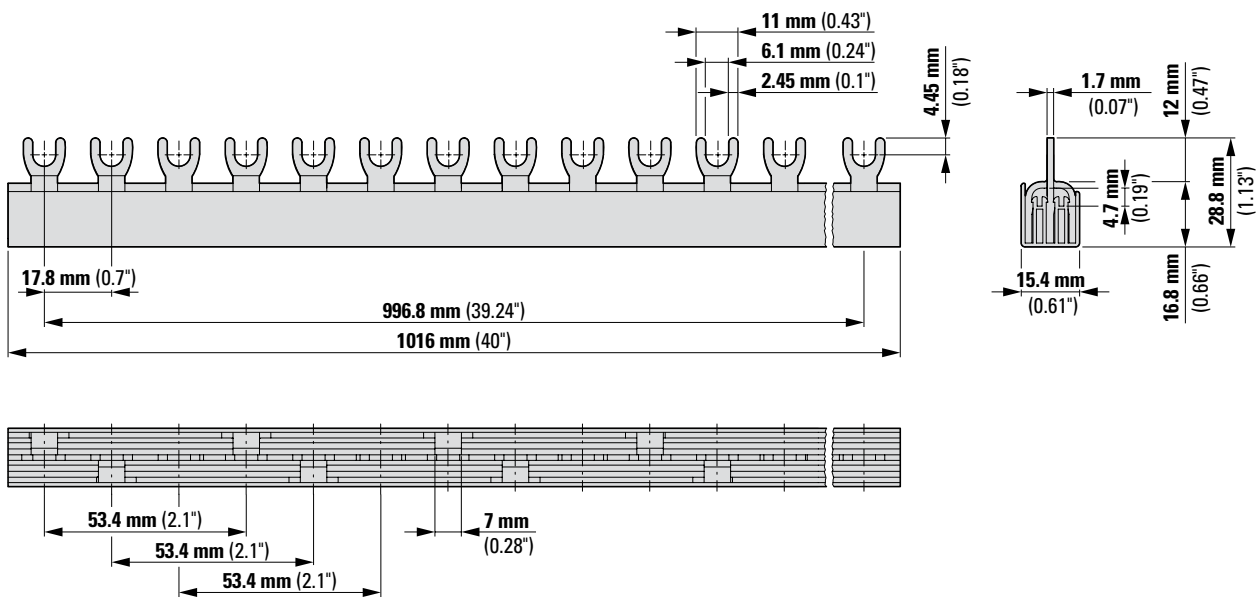



### Busbar dimensions (mm)

GVK-16/3P+N-4TE

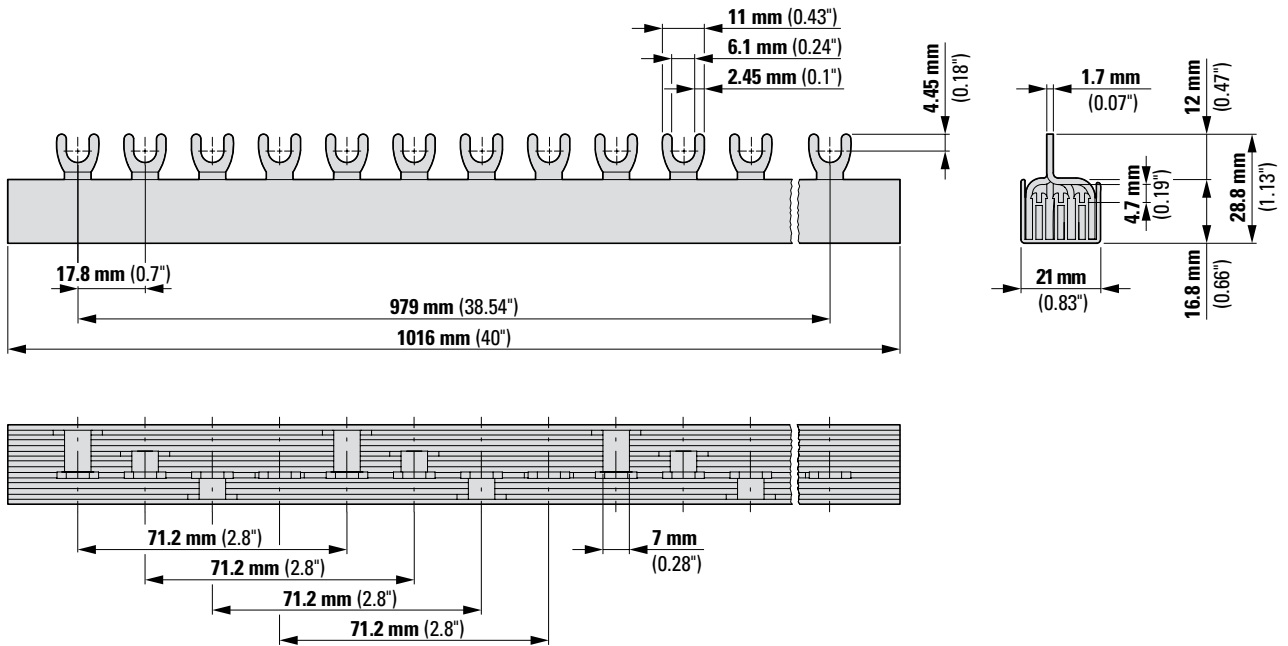

GVK-16/3P+3N-6TE

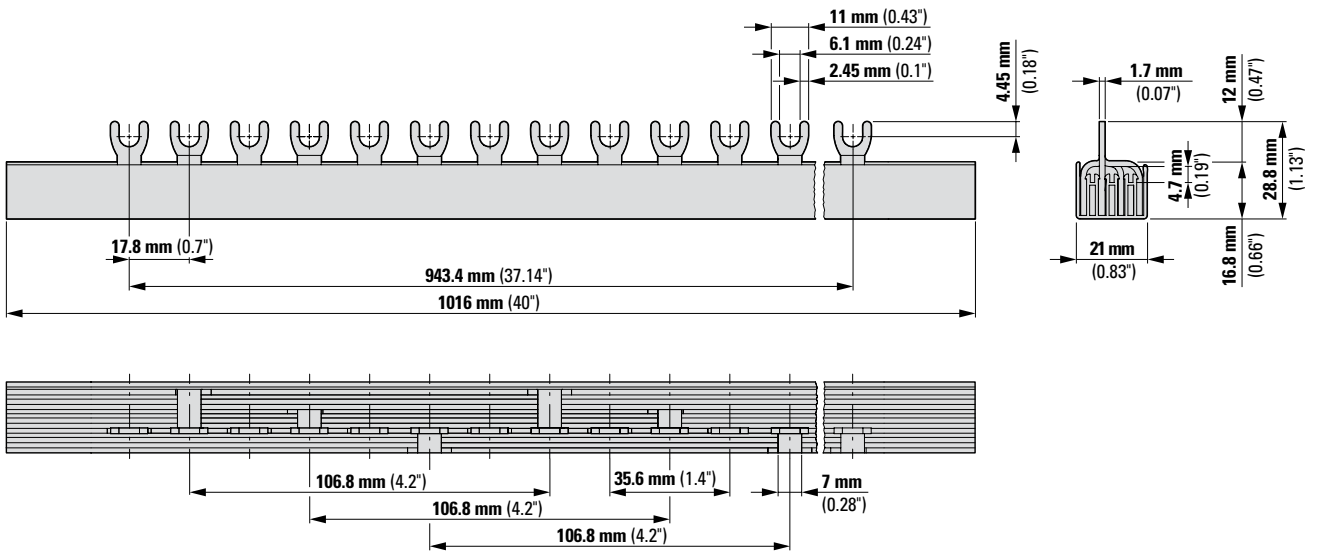

WA\_SG11302

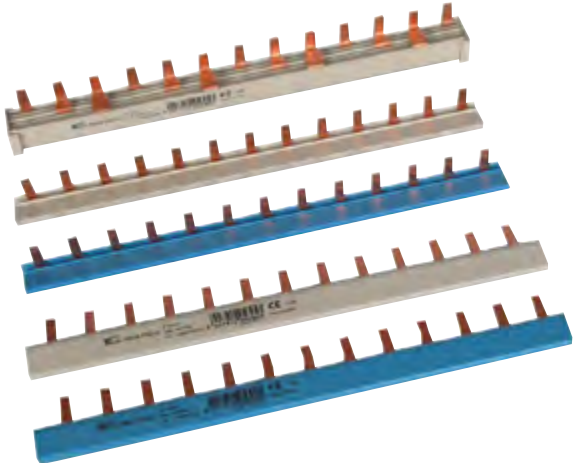

WA\_SG11302

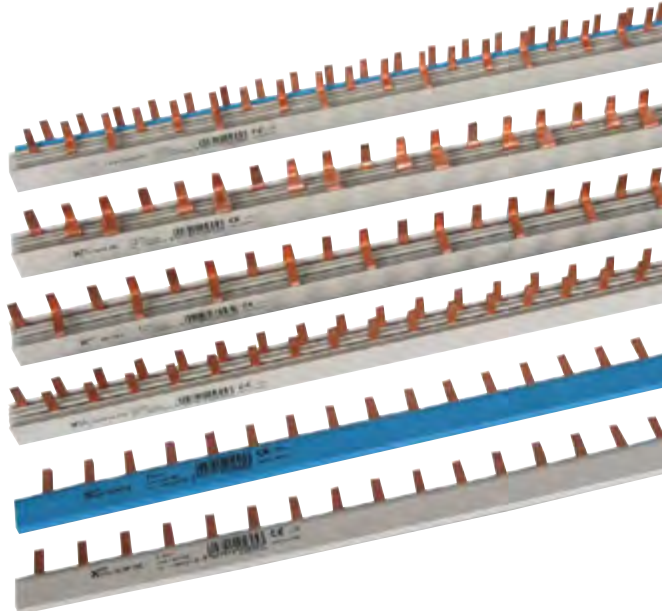

Description	Cu-factor	Type Designation	Article No.	Units per package
-------------	-----------	------------------	-------------	-------------------

### Busbar Block (Fork and Pin) Z-GSV

- for PLS.1N (1.5MU)

### Busbar Block (Fork and Pin) Z-GSV

- delivered with end caps

#### 10 mm<sup>2</sup> - Rated current 63 A

4-phases	0.208	Z-GSV-10/FI+EH+2XLS1N	113138	10
4-phases	0.277	Z-GSV-10/FI+EH+4XLS1N	113139	10

#### 16 mm<sup>2</sup> - Rated current 80 A

4-phases 3x	0.408	Z-GSV-16/3P+3N/9	271079	15
-------------	-------	------------------	--------	----



### Busbar Block (Fork and Pin) Z-GSV, 1 Meter

- delivered without end caps

#### 16 mm<sup>2</sup> - Rated current 80 A

2-phases	0.585	Z-GSV-16/1P+N	271067	10
4-phases	1.840	Z-GSV-16/3P+3N	271068	10
4-phases	2.196	Z-GSV-16/FI+EH+KR+30XLS1N	113137	7
End cap 4-phases		Z-V-AK/4P	264931	10 / 600

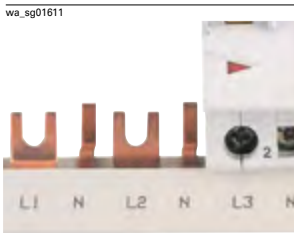

### Description of the Busbar Block (Fork and Pin) Z-GSV

Devices to busbar	Pcs. of the devices	End caps	Type
<p>4-phases</p>		Z-V-AK/4P	Z-GSV-10/FI+EH+2XLS1N
<p>4-phases</p>		Z-V-AK/4P	Z-GSV-10/FI+EH+4XLS1N
<p>2-phases</p>	x37 x9	Z-AK-16/2+3P	Z-GSV-16/1P+N Z-GSV-16/1P+N/9
<p>4-phases</p>	x37 x9	Z-AK-16/4P	Z-GSV-16/3P+3N Z-GSV-16/3P+3N/9
<p>4-phases</p>	30x	Z-V-AK/4P	Z-GSV-16/FI+EH+KR+30XLS1N

**Description Busbar Block 10mm<sup>2</sup>, 16mm<sup>2</sup> (Fork and Pin) Z-GSV**

- Length 1m
- Delivered without end caps. Please order separately.
- Short version (/9) delivered with end caps

**Technical Data**

	<b>Z-GSV</b>
<b>Electrical</b>	
Rated voltage	240/415 V, 50/60 Hz
Rated current	
10 mm <sup>2</sup>	63 A
16 mm <sup>2</sup>	80 A
Short-circuit current strength	25 kA
<b>Mechanical</b>	
Busbar cross section	10 and 16 mm <sup>2</sup> Cu
Step distance	26.7 mm

**Connection diagram**

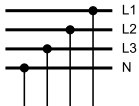

**Dimensions (mm)**

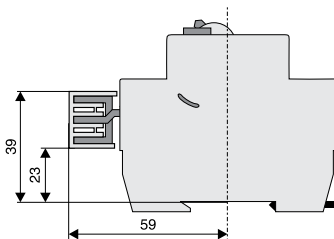

Description	Cu-factor	Type Designation	Article No.	Units per package
-------------	-----------	------------------	-------------	-------------------

### Busbar Block (Pin) Z-SV...-SD, 1 Meter

- For Protected Earth Socket Z-SD230
- delivered with end caps

#### 10 mm<sup>2</sup> - Rated current 50 A

Z-phases	0.588	Z-SV-10/1P+N-SD	269526	10
End caps		Z-V-AK/2+3P	264930	10 / 600

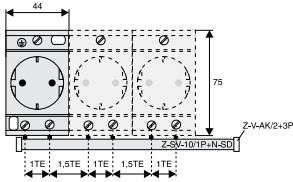

### Description Busbar Block 10mm<sup>2</sup> (Pin) Z-SV ...-SD

- Delivered without end caps
- Step (distance between two pins of identical phase, i. e. L or N) 2.5 MU
- Length 1 m

### Technical Data

	Z-SV-10/1P+N-SD
<b>Electrical</b>	
Rated voltage	230/400 V, 50/60 Hz
Rated current	50 A
Short-circuit current strength	25 kA
<b>Mechanical</b>	
Busbar cross section	10 mm <sup>2</sup> Cu
Step distance	44 mm

### Connection diagram

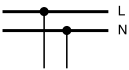

### Accessories

WA\_SG10602



End caps

WA\_SG10702



Extension terminal  
Z-EK/25/QL

WA\_SG10702



Extension terminal  
Z-EK/25

Description	Cu-factor	Type Designation	Article No.	Units per package
-------------	-----------	------------------	-------------	-------------------

**Busbar Block (Pin) Z-SV**

- for PLN. (1MU), Z-SI

**Busbar Block (Pin) Z-SV, 13TE**

- delivered with end caps

WA\_SG11302

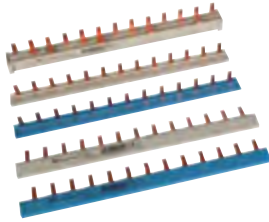

**10 mm<sup>2</sup> - Rated current 50 A**

1-phase straight grey	0.055	Z-SV-10/1P-1MU/13	264916	10
1-phase straight blue	0.055	Z-SV-10/N-1MU/13	264917	10
1-phase angulated grey	0.055	Z-SV-10/1P-F/13	264918	10
1-phase angulated blue	0.055	Z-SV-10/N-F/13	264919	10
2-phases	0.126	Z-SV-10/2P-2MU/13	264922	10
3-phases	0.203	Z-SV-10/3P-3TE/13	264924	10
4-phases	0.258	Z-SV-10/3P+N-4TE/12	264926	10
4-phases (for PLN.)	0.258	Z-SV-10/3P+3N-3TE/13	264927	10

**Busbar Block (Pin) Z-SV, 1 Meter**

- delivered without end caps

WA\_SG11302

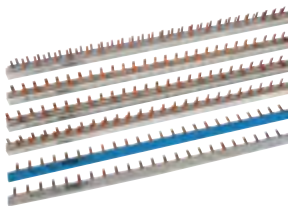

**16 mm<sup>2</sup> - Rated current 63 A**

1-phase straight grey	0.385	Z-SV-16/1P-1MU	264912	25
1-phase straight blue	0.385	Z-SV-16/N-1MU	264913	25
1-phase angulated grey	0.385	Z-SV-16/1P-1MU/F	269523	25
1-phase angulated blue	0.385	Z-SV-16/N-1MU/F	269524	25
2-phases	0.941	Z-SV-16/2P-2MU	264923	10
3-phases (for PLN.)	1.326	Z-SV-16/2P+2N-2MU	264914	7
3-phases	1.422	Z-SV-16/3P-3TE	264925	10
4-phases	2.177	Z-SV-16/3P+N-4TE	264928	7
4-phases (for PLN.)	1.807	Z-SV-16/3P+3N-3TE	264915	7

Description	Type Designation	Article No.	Units per package
-------------	------------------	-------------	-------------------

**Accessories**

**End caps, Z-V-AK/, Z-BB-EC/4P**

wa\_sg05413



1-phase	Z-V-AK/1P	104905	10 / 600
2+3-phases	Z-V-AK/2+3P	264930	10 / 600
4-phases	Z-BB-EC/4P <sup>1)</sup>	183116	10 / 600

<sup>1)</sup> only for Z-SV-16/3P+N-4TE, Article No. 264928

**Extension terminals 6 - 25 mm<sup>2</sup>, Z-EK/25**

wa\_sg02512



long, straight	Z-EK/25	264935	10 / 600
short, straight	Z-EK/25/K	269525	10 / 600
long, crosswise	Z-EK/25/QL	264937	10 / 600
short, crosswise	Z-EK/25/Q	264936	10 / 600











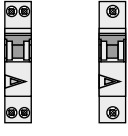

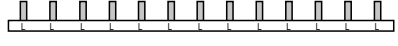

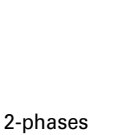
**Busbar Tag Shrouds for busbar, yellow ZV-BS-G**

SG05705

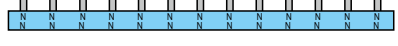
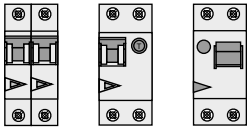

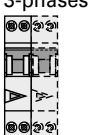
Finger and hand touch safe	ZV-BS-G	104903	10/600
----------------------------	---------	--------	--------

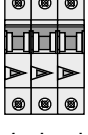
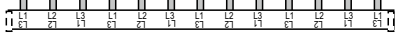
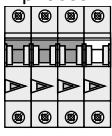
### Description of the Busbar Block (Pin) Z-SV

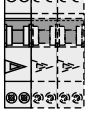
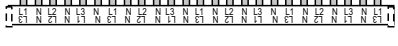
Devices to busbar	Pcs. of the devices	End caps		Type
1-phase + 2-phases 	x13			Z-SV-10/1P-F/13
	x56			Z-SV-16/1P-1TE/F
	x13			Z-SV-10/N-F/13
	x56			Z-SV-16/N-1TE/F
1-phase + 2-phases 	x13			Z-SV-10/1P-1TE/13
	x56			Z-SV-16/1P-1TE
	x13			Z-SV-10/N-1TE/13
	x56			Z-SV-16/N-1TE
2-phases 	x6	Z-V-AK/2+3P		Z-SV-10/2P-2TE/13
	x28			Z-SV-16/2P-2TE
3-phases 	x56	Z-V-AK/2+3P		Z-SV-16/2P+2N-2TE
3-phases 	x4	Z-V-AK/2+3P		Z-SV-10/3P-3TE/13
	x19			Z-SV-16/3P-3TE
4-phases 	x3	Z-V-AK/4P		Z-SV-10/3P+N-4TE/12
	x14	Z-BB-EC/4P		Z-SV-16/3P+N-4TE
4-phases 	x13	Z-V-AK/2+3P		Z-SV-10/3P+3N-3TE/13
	x56			Z-SV-16/3P+3N-3TE

### Example

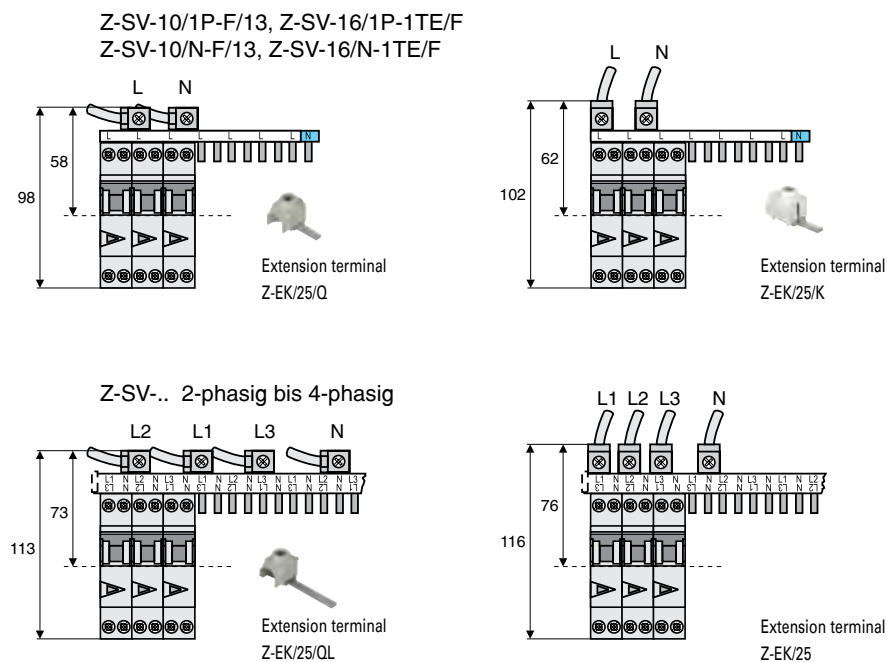

**Description Busbar Block 10mm<sup>2</sup> (Pin) Z-SV-10/, 16mm<sup>2</sup> (Pin) Z-SV-16/**

- Busbar Block 10 mm<sup>2</sup> delivered with end caps, length 13TE
- Busbar Block 16 mm<sup>2</sup> without end caps, length 1m

**Technical Data**

	<b>Z-SV</b>
<b>Electrical</b>	
Rated voltage	240/415 V, 50/60 Hz
Rated current	
10 mm <sup>2</sup>	50 A
16 mm <sup>2</sup>	63 A
Short-circuit current strength	25 kA
<b>Mechanical</b>	
Busbar cross section	10 and 16 mm <sup>2</sup> Cu
Step distance	17.80 mm

**Connection diagram**

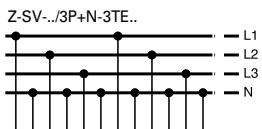

**Accessories**

SG4800



End caps

WA\_SG10702



Extension terminal  
Z-EK/25/Q

SG07703



Extension terminal  
Z-EK/25/K

WA\_SG10702



Extension terminal  
Z-EK/25/QL

WA\_SG10702



Extension terminal  
Z-EK/25



Description	Cu-factor	Type Designation	Article No.	Units per package
-------------	-----------	------------------	-------------	-------------------

#### Busbar Block 12MU (Fork and Pin) Z-GSV-10

- for PLN. (1MU) + FI
- delivered with end caps

SG4700

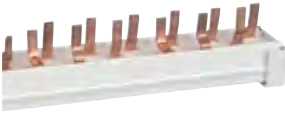

#### 10 mm<sup>2</sup> - Rated current 50 A







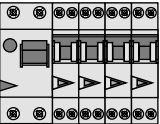

##### below

2-phases, RCD-2p + 4xPLN	0.07	Z-GSV-10/1P+N-NL/6	274297	10 / 200
2-phases, RCD-2p + 10xPLN	0.131	Z-GSV-10/1P+N/12-U	274299	10 / 100
4-phases, RCD-4p + 4xPLN	0.13	Z-GSV-10/3P+N-NL/8	116858	10
4-phases, RCD-4p + 8xPLN	0.463	Z-GSV-10/3P+N/12-U	274400	10 / 100
4-phases, RCD-4p + 3xPLS. + 5xPLN	0.463	Z-GSV-10/3P+N/12H-U	274401	10 / 100

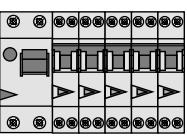
##### above

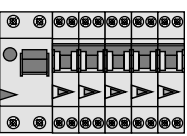
2-phases, RCD-2p + 10xPLN	0.131	Z-GSV-10/1P+N/12-O	274402	10 / 100
4-phases, RCD-4p + 8xPLN	0.463	Z-GSV-10/3P+N/12-O	274403	10 / 100

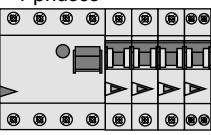
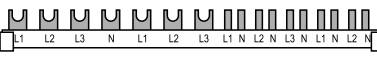
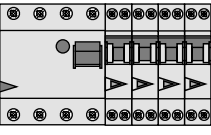
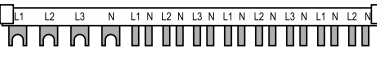
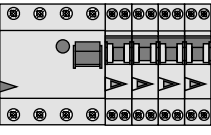
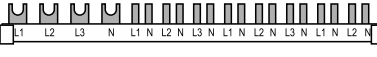
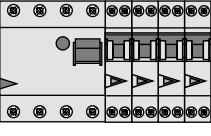
#### Description of the Busbar Block 12MU (Fork and Pin) Z-GSV-10

Devices to busbar	Pcs. of the devices	End caps	Type
 <p>2-phases xPLN</p>		 <p>Z-V-AK/2+3P</p>	Z-GSV-10/1P+N-NL/6
 <p>x10</p>		 <p>Z-V-AK/2+3P</p>	Z-GSV-10/1P+N/12-O
 <p>x10</p>		 <p>Z-V-AK/2+3P</p>	Z-GSV-10/1P+N/12-U
 <p>4-phases 5</p>		 <p>Z-V-AK/4P</p>	Z-GSV-10/3P+N/12H-U
 <p>x8</p>		 <p>Z-V-AK/4P</p>	Z-GSV-10/3P+N/12-O
 <p>x8</p>		 <p>Z-V-AK/4P</p>	Z-GSV-10/3P+N/12-U
 <p>4xPLN</p>		 <p>Z-V-AK/4P</p>	Z-GSV-10/3P+N-NL/8

**Description Busbar Block 12MU 10mm<sup>2</sup> (Fork and Pin) Z-GSV-10**

- 12MU busbar elements incl. end caps

**Technical Data**

	<b>Z-GSV-10</b>
<b>Electrical</b>	
Rated voltage	240/415 V, 50/60 Hz
Rated current	50 A
Short-circuit current strength	25 kA
<b>Mechanical</b>	
Busbar cross section	10 mm <sup>2</sup> Cu
Step distance	17.95 mm

**Connection diagram**

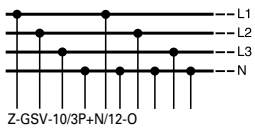

**Accessories**

WA\_SG10702



Extension terminal  
Z-EK/25/QL

WA\_SG10702



Extension terminal  
Z-EK/25

Description	Cu-factor	Type Designation	Article No.	Units per package
-------------	-----------	------------------	-------------	-------------------

#### Busbar Block 13MU (Fork and Pin) Z-GSV-10

- for 1x RCD + PLG. (1MU)
- Do not cut!! 

wa\_sg14303

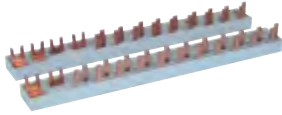

#### 10 mm<sup>2</sup> - Rated current 63 A

##### above

2-phases, RCD-2p + 11xPLG	0.251	Z-GSV-10/1P+N-F/13	264920	10
---------------------------	-------	--------------------	--------	----

Description	Type Designation	Article No.	Units per package
-------------	------------------	-------------	-------------------

#### Accessories

##### Extension terminals 6 - 25 mm<sup>2</sup>, Z-EK/25

wa\_sg02512



long, straight	Z-EK/25	264935	10 / 600
long, crosswise	Z-EK/25/QL	264937	10 / 600

##### Busbar Tag Shrouds for busbar, yellow ZV-BS-G

SG05705



Finger and hand touch safe	ZV-BS-G	104903	10/600
----------------------------	---------	--------	--------

#### Description of the Busbar Block 13MU (Fork and Pin) Z-GSV-10

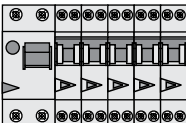
Devices to busbar	Pcs. of the devices	Type
2-phases 	x11	Z-GSV-10/1P+N-F/13

#### Description Busbar Block 13MU 10mm<sup>2</sup> (Fork and Pin) Z-GSV-10

- 13MU busbar elements without end caps



#### Technical Data

Z-GSV-10	
<b>Electrical</b>	
Rated voltage	240/415 V, 50/60 Hz
Rated current	63 A
Short-circuit current strength	25 kA
<b>Mechanical</b>	
Busbar cross section	10 mm <sup>2</sup> Cu
Step distance	17.95 mm

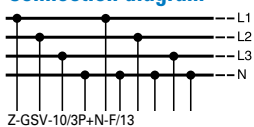
#### Connection diagram



#### Accessories

 WA_SG10602 End caps	 WA_SG10702 Extension terminal Z-EK/25/QL	 WA_SG10702 Extension terminal Z-EK/25
---	--	---

Description	Cu-factor	Type Designation	Article No.	Units per package
-------------	-----------	------------------	-------------	-------------------

**Busbar Block (Pin) Z-SV-../1P+N-F**

- for 1x PFGC + PLGC. (1MU)
- 2-phases
- Do not cut!! 



**10 mm<sup>2</sup> - Rated current 50 A**

PFGC + 4x PLGC	0.105	Z-SV-10/1P+N-F/6	107944	10 / 100
PFGC + 7x PLGC	0.155	Z-SV-10/1P+N-F/9	107943	10 / 100
PFGC + 11x PLGC	0.22	Z-SV-10/1P+N-F/13	107942	10 / 100

**16 mm<sup>2</sup> - Rated current 63 A**

PFGC + 4x PLGC	0.155	Z-SV-16/1P+N-F/6	191245	10 / 100
PFGC + 7x PLGC	0.231	Z-SV-16/1P+N-F/9	191244	10 / 100
PFGC + 8x PLGC	0.259	Z-SV-16/1P+N-F/10	191246	10 / 100
PFGC + 11x PLGC	0.328	Z-SV-16/1P+N-F/13	191243	10 / 100

Description	Type Designation	Article No.	Units per package
-------------	------------------	-------------	-------------------





**Accessories**

**Busbar Tag Shrouds for busbar, yellow ZV-BS-G**

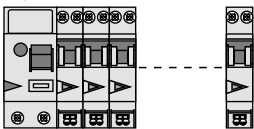

Finger and hand touch safe	ZV-BS-G	104903	10/600
----------------------------	---------	--------	--------

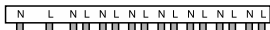
**Description of the Busbar Block (Pin) Z-SV-../1P+N-F**

Devices to busbar	Pcs. of the devices	Type
2-phases 	x4	 Z-SV-../1P+N-F/6
	x7	 Z-SV-../1P+N-F/9
	x8	 Z-SV-16/1P+N-F/10
	x11	 Z-SV-../1P+N-F/13

**Description Busbar Block 10/16mm<sup>2</sup> (Pin) Z-SV-../1P+N-F**

- Busbar elements without end caps

## Technical Data

		Z-SV-../1P+N-F
<b>Electrical</b>		
Rated voltage		240/415 V, 50/60 Hz
Rated current		
10 mm <sup>2</sup>		50 A
16 mm <sup>2</sup>		63 A
Overtoltage category		III
Rated peak withstand voltage	$U_{imp}$	4 kV
Conditional rated short circuit current AC with 125 A gG		10 kA
<b>Mechanical</b>		
Busbar cross section		10 and 16 mm <sup>2</sup> Cu
Step distance		17.8 mm
Flame class according to UL94		V0, glowing wire test 960 °C
Pollution degree		2
Comparative tracking index		CTI 300
Air gap		≥ 5.5 mm
Minimum creepage distance		≥ 5 mm

## Connection diagram

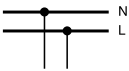

## Dimensions (mm)

Z-SV-10/1P+N-F/6, Z-SV-16/1P+N-F/6

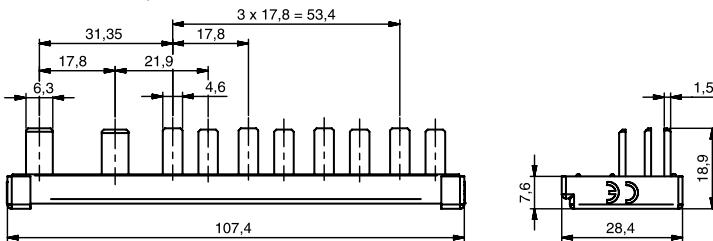

Z-SV-10/1P+N-F/9, Z-SV-16/1P+N-F/9

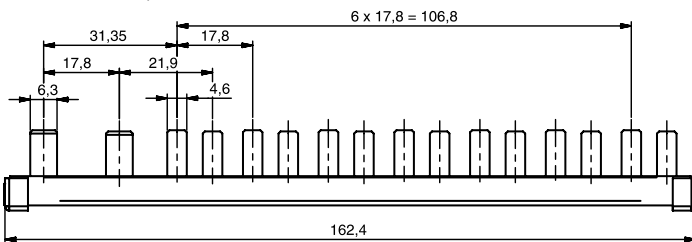

Z-SV-16/1P+N-F/10

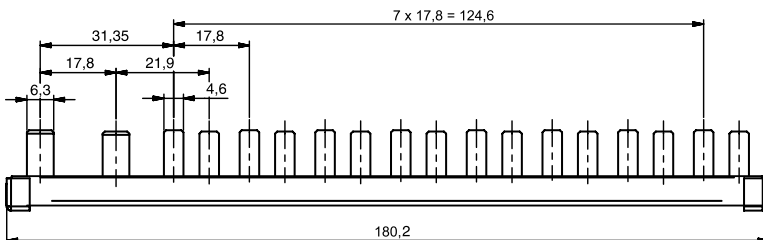

Z-SV-10/1P+N-F/13, Z-SV-16/1P+N-F/13

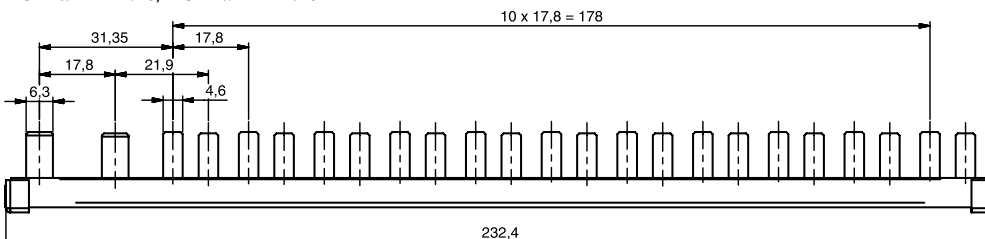

wa\_sg03511

---



---

### Description

- For MCB FAZ-NA/RT
- 16 mm<sup>2</sup>
- Pin busbar
- Accessories available:
  - Terminals
  - Busbar tag shrouds
- Several length

Description	Step Distance (mm)	Cu-factor	Type Designation	Article No.	Units per package
-------------	--------------------	-----------	------------------	-------------	-------------------

**For FAZ-NA/RT, not sliceable!!**

- Delivered with end caps

wa\_sg03511



**16 mm<sup>2</sup>, Rated current 80 A**

1-phase, 6MU	17.6	0.035	Z-SV/UL-16/1P-1TE/6	104892	10
1-phase, 12MU	17.6	0.07	Z-SV/UL-16/1P-1TE/12	104893	10
1-phase, 18MU	17.6	0.105	Z-SV/UL-16/1P-1TE/18	104894	10
2-phase, 6MU	17.6	0.07	Z-SV/UL-16/2P-2TE/6	104895	10
2-phase, 12MU	17.6	0.14	Z-SV/UL-16/2P-2TE/12	104896	10
2-phase, 18MU	17.6	0.21	Z-SV/UL-16/2P-2TE/18	104897	10
3-phase, 6MU	17.6	0.14	Z-SV/UL-16/3P-3TE/6	104898	10
3-phase, 12MU	17.6	0.221	Z-SV/UL-16/3P-3TE/12	104899	10
3-phase, 18MU	17.6	0.332	Z-SV/UL-16/3P-3TE/18	104900	10

**Accessories**

**Terminals**

SG07506



2,5 - 35mm <sup>2</sup>	-	0.035	Z-EK/35/UL	104901	3
1,5 - 50mm <sup>2</sup>	-	0.038	Z-EB/50/UL	104902	3

**Busbar Tag Shrouds**

SG07706



for 3 pins	-	-	ZV-BS-UL	104904	10
------------	---	---	----------	--------	----

**Description of UL489-Busbar**

Devices to busbar	Pcs. of the devices		Type
<p>1-phase</p>	x6		Z-SV/UL-16/1P-1TE/6
	x12		Z-SV/UL-16/1P-1TE/12
	x18		Z-SV/UL-16/1P-1TE/18
<p>2-phases</p>	x3		Z-SV/UL-16/2P-2TE/6
	x6		Z-SV/UL-16/2P-2TE/12
	x9		Z-SV/UL-16/2P-2TE/18
<p>3-phases</p>	x2		Z-SV/UL-16/3P-3TE/6
	x4		Z-SV/UL-16/3P-3TE/12
	x6		Z-SV/UL-16/3P-3TE/18

**Description of the Busbar UL489 Z-SV/UL-16 for FAZ-NA/RT**

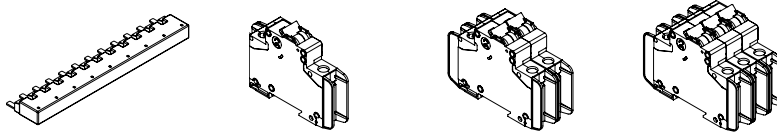

Article No.				
104892	Z-SV/UL-16/1P-1TE/6	6	-	-
104893	Z-SV/UL-16/1P-1TE/12	12	-	-
104894	Z-SV/UL-16/1P-1TE/18	18	-	-
104895	Z-SV/UL-16/2P-2TE/6	-	3	-
104896	Z-SV/UL-16/2P-2TE/12	-	6	-
104897	Z-SV/UL-16/2P-2TE/18	-	9	-
104898	Z-SV/UL-16/3P-3TE/6	-	-	2
104899	Z-SV/UL-16/3P-3TE/12	-	-	4
104900	Z-SV/UL-16/3P-3TE/18	-	-	6
104901	Z-EK/35/UL	-	-	-
104902	Z-EB/50/UL	-	-	-
104904	ZV-BS-UL	-	-	-

**Technical Data**

<b>Z-SV/UL16</b>	
<b>General</b>	
Heat deflection temperature	125°C - UL94 V0
Standards	
Busbar	UL489, DIN EN 60947-1, VDE 0660 Teil 100 = IEC 60947-1:2004, IEC 60947-2:2003
Terminal	IEC 60999:2000, UL489, UL486A, CSA C22.2
Climate stability	according to DIN EN 60068
Insulation coordination	Overtoltage category III / Pollution degree 2
<b>Electrical</b>	
Impulse voltage strenght	≥ 9.5 kV (1 kV / mmLS)
Min. air distance	> 9.5 mm/25.4 mm (proprietary/external)
Min. creeping distance	> 12.7 mm/50.8 mm (proprietary/external)
Max. operating voltage	
1-, 3-phase	690 V IEC 480Y/277V & 240 V AC
Terminals	1.000 V AC/DC
Max. busbar current	$I_n$ /Phase 80 A
Protection class	IP20
Short circuit rating	15 kA mit NH3 355 A gL 500 V JM / 7.5 kA 3 cycles @ 600 V
Dielectric strenght	>30 kV/mm

**Connection diagram**

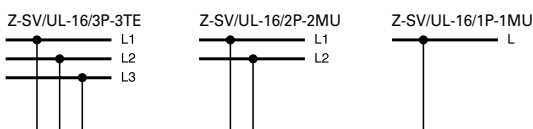



## Mounting example of busbar UL489 Z-SV/UL-16 for FAZ-NA/RT

- ! ATTENTION:** Maximum of 3 commoning links allowed. Any combination of same pole configuration.
- ATTENTION:** 3 liaisons communes autorisées au maximum. Toute combinaison de configurations de polarité identiques.
- ACHTUNG:** Maximal 3 Schienenblöcke. Beliebige Kombination gleichpoliger Konfigurationen.
- ATTENZIONE:** Sono consentiti al massimo 3 pettini di collegamento in qualsiasi combinazione della stessa configurazione di poli.
- ATEÏON:** Se permite un máximo de 3 enlaces comunes. Cualquier combinación del mismo tipo de configuración de polo

- ! ~~✂~~ ATTENTION:** Do not cut.
- ATTENTION:** Ne pas couper.
- ACHTUNG:** Nicht durchschneiden.
- ATTENZIONE:** Non tagliare.
- ATEÏON:** No corte.

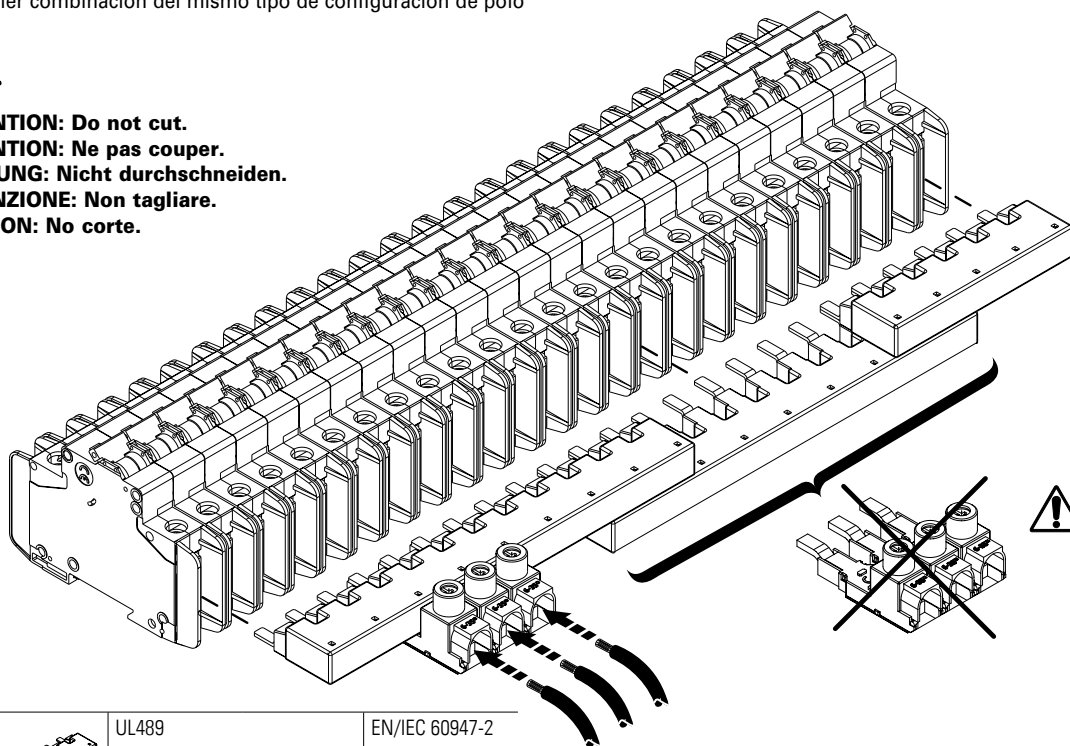

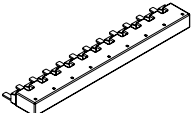
	UL489	EN/IEC 60947-2	
$U_e$	480 V AC	96 V DC	240/415 V AC
$f$	50/60 Hz	—	50/60 Hz
$U_{imp}$	—	—	9,5 kV
$I_e$	80 A @ 40°C	—	80 A @ 30°C
Terminal capacity	—	—	16 mm <sup>2</sup>

### Z-EB/50/UL

	UL489	EN/IEC 60947-2	
$U_e$	480 V AC	96 V DC	240/415 V AC
$f$	50/60 Hz	—	50/60 Hz
$U_{imp}$	—	—	9,5 kV

Cross section:

	U - single wire	K - fine wire (with sleeve)	Torque
	R - multi wire	F - fine wire (with sleeve)	
Max. cross section	50 mm <sup>2</sup> 1 AWG copper wire	35 mm <sup>2</sup> 2 AWG copper wire	4 Nm 35 lbf.in
Min. cross section	1,5 mm <sup>2</sup> 14 AWG copper wire		
Busbar-side	Pin max. 5,5x2 / 0.2"x0.07" Länge min. 12,7 mm / Length min. 0.5"		2,5 Nm 22 lbf.in

### Z-EK/35/UL

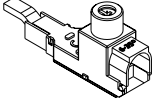
	UL489	EN/IEC 60947-2	
$U_e$	480 V AC	96 V DC	240/415 V AC
$f$	50/60 Hz	—	50/60 Hz
$U_{imp}$	—	—	9,5 kV

Cross section:

	U - single wire	K - fine wire (with sleeve)	Torque
	R - multi wire	F - fine wire (with sleeve)	
Max. cross section	35 mm <sup>2</sup> 2 AWG copper wire		5,5 Nm 50 lbf.in
Min. cross section	2,5 mm <sup>2</sup> 14 AWG copper wire		

Mounting example of busbar UL489 Z-SV/UL-16 for FAZ-NA/RT

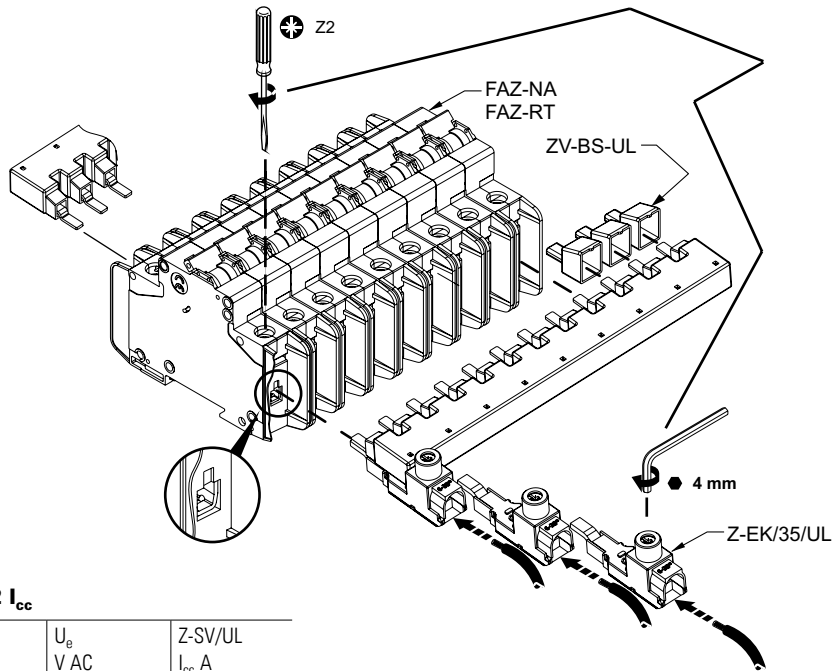

AWG	lb-in	Nm
14	21	2.3
12-8	25	2.8
6-2	36	4.0

IEC/EN 60947-2 I<sub>cc</sub>

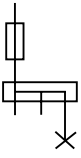
	U <sub>e</sub> V AC	Z-SV/UL I <sub>cc</sub> A
	240/415	15000

UL SCCR

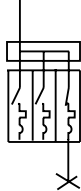
	FAZ-NA FAZ-RT I <sub>n</sub> A	U <sub>e</sub> V AC	Z-SV/UL SCCR RMS Sym A
	0.5-32	480Y/277	10000
	35-40	240	10000

Dimensions (mm)

Z-SV/UL-16/.TE/6

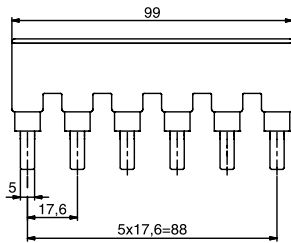

Z-SV/UL-16/.TE/12

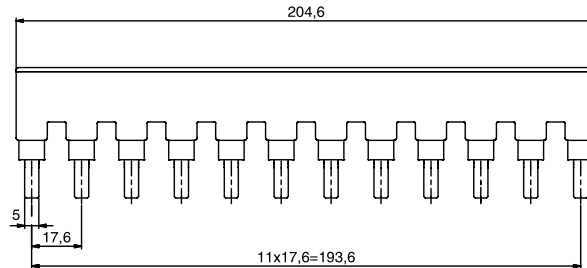

ZV-BS-UL

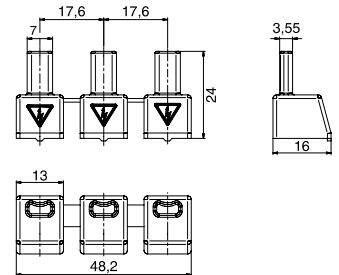

Z-SV/UL-16/.TE/18

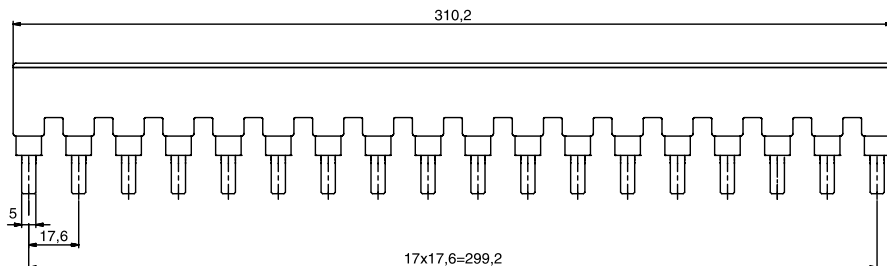

Z-EK/35/UL

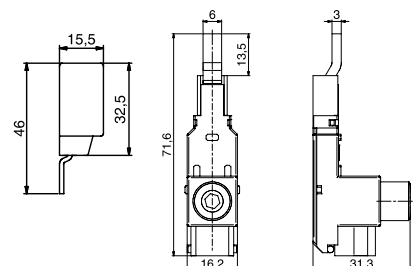

## Example

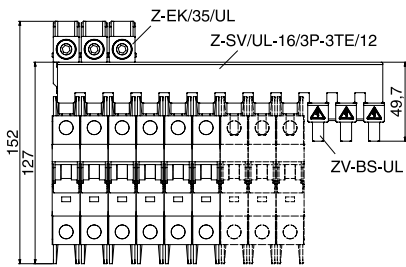

## Z-EK/35/UL

	UL489	IEC/EN60947-2
	# 2-14 AWG 60/75 °C Cu	2.5-35 mm <sup>2</sup> Cu
	0.56 in	14 mm
<b>tested acc. to</b>		<b>Tightening torque</b>
UL486A	# 14 AWG	≥ 2.3 Nm
UL486B	# 8-12 AWG	≥ 2.8 Nm
UL486E	# 6-1 AWG	4 Nm

Description	Cu-factor	Type Designation	Article No.	Units per package
-------------	-----------	------------------	-------------	-------------------

**Busbar Block (Pin) Z-SV**

- delivered without end caps

**Busbar Block (Pin) Z-SV-16/3P**

- for Z-SLS, PLHT, DO.-SO/.. (1.5MU)

wa\_sg03611

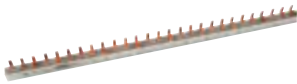

**16 mm<sup>2</sup> - Rated current 80 A**

3-phases	0.84	Z-SV-16/3P	271072	20
----------	------	------------	--------	----

**Accessories for Z-SV-16/3P**

**Extension terminal**

wa\_sg05913



Extension terminal 6-50 mm <sup>2</sup>		Z-EK/50	264934	3 / 180
---	--	---------	--------	---------

**End cap**

SG4800



End cap		Z-V-35/AK/3P	264932	10 / 600
---------	--	--------------	--------	----------

**Busbar Block (Pin) Z-SV-35**

- for Z-SLS, PLHT, DO.-SO/.. (1.5MU), PLHT-V (1.5MU)

wa\_sg03711

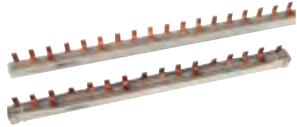

**35 mm<sup>2</sup> - Rated current 110 A**

1-phase angulated grey	0.83	Z-SV-35/1P	113135	1
3-phases	2.74	Z-SV-35/3P	264938	4
3-phases	2.74	Z-SV-35/PLHT-V	264939	4
4-phases*	1.57	Z-SV-35/3P+N-6TE	263110	4

\* delivered with end caps

**Accessories for Z-SV-35**

**End cap**

SG4800



End cap		Z-V-35/AK/3P	264932	10 / 600
---------	--	--------------	--------	----------

**Accessories for Z-SV-35**

**Extension terminals Z-EK/95**

- 25-95 mm<sup>2</sup> single-/multi-wire
- 16-70 mm<sup>2</sup> fine wires with wire end sleeve
- Max. tightening torque: 19 Nm

wa\_sg05513



for Z-SV-35/1P		Z-EK/95-1	113136	3 / 90
for Z-SV-... 3-phases		Z-EK/95	264933	3 / 90
for Z-SV-35/3P+N		Z-EK/95-3N	264911	4 / 120

### Description of the Busbar Block (Pin) Z-SV

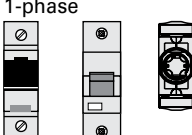
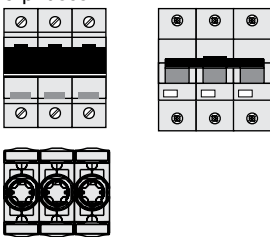
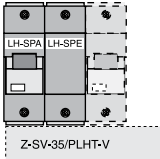
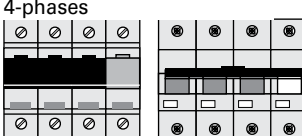
Devices to busbar	Pcs. of the devices	End caps	Type
<p>1-phase</p> 	x36		Z-SV-35/1P
<p>3-phases</p> 	x12	<p>Z-AK-16/2+3P</p> <p>Z-V-35AK/3P</p>	<p>Z-SV-16/3P</p> <p>Z-SV-35/3P</p>
 <p>Z-SV-35/PLHT-V</p>	x33	Z-V-35AK/3P	Z-SV-35/PLHT-V
<p>4-phases</p> 	x4	Z-V-35AK/3P	Z-SV-35/3P+N-6TE

### Description Busbar Block (Pin) Z-SV

- End caps are to be ordered separately, exception Z-SV-35/3P+N-6TE
- Halogenfree plastic

### Technical Data

	Z-SV-16	Z-SV-35
<b>Electrical</b>		
Rated operational voltage	240/415 V AC	240/415 V AC
Rated frequency	50/60 Hz	50/60 Hz
Rated voltage	500 V	690 V
Overvoltage category	III	III
Rated peak withstand voltage	$U_{imp}$ 4 kV	6 kV
Rated current	80 A	110 A
Conditional rated short circuit current AC with 250 A gG	50 kA <sub>r.m.s.</sub>	100 kA <sub>r.m.s.</sub>
<b>Mechanical</b>		
Busbar cross section	16 mm <sup>2</sup> Cu	35 mm <sup>2</sup> Cu
Step distance	27 mm	27 mm (Z-SV-35/PLHT-V 30.5 mm)
Flame class according to UL94	V0, glowing wire test 960 °C	V0, glowing wire test 850 °C
Degree of protection, with end caps	IP20	IP20
Pollution degree	2	
Comparative tracking index	CTI 300	CTI 600
Air gap	≥ 5 mm	≥ 4.3 mm
Minimum creepage distance	≥ 10.2 mm	≥ 6.7 mm

Dimensions (mm)

	n	A	B	C	D	E	F	G	H	I
Z-SV-16/3P	35	27	5	945	971	14.9	31	1.5	17	19
Z-SV-35/3P	35	27	8.5	945	1000	19.7	38.4	2.5	21.5	23.9
Z-SV-35/PLHT-V	32	30.5	8.5	976	1000	19.7	38.4	2.5	21.5	23.9

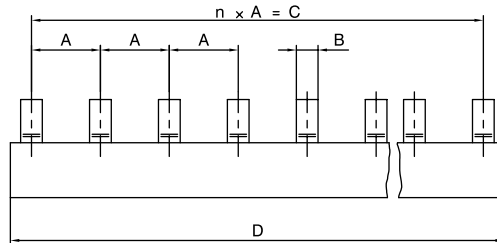
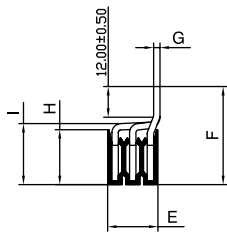

Accessories for Z-SV-16

Wa\_sg10802



Extension terminal  
Z-EK/50

Z-SV-35/3P+N-6TE

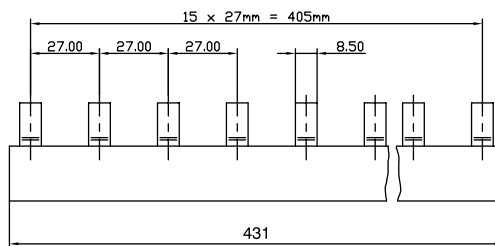
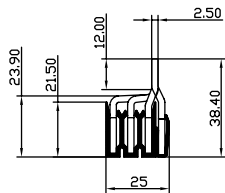

Accessories for Z-SV-35

Wa\_sg10802



Extension terminal  
Z-EK/95, Z-EK/95-3N,  
Z-EK/95-1

Z-SV-35/1P

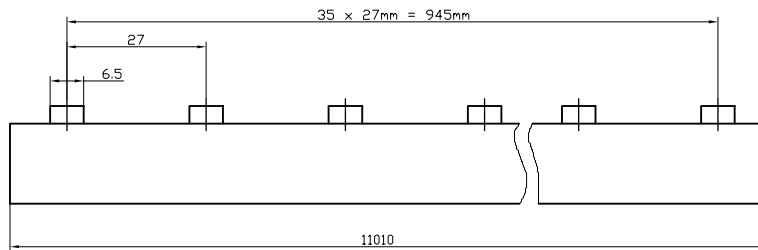
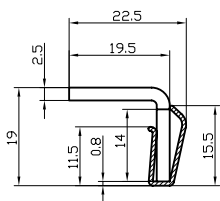

Phases	MU	Cu-factor	Type Designation	Article No.	Units per package
--------	----	-----------	------------------	-------------	-------------------

### Euro-Vario-Busbar (Fork) EVG

- for PLS., PKN., PFIM, PFHM, PFNM
- no end caps necessary
- Do not cut!! 

### 10 mm<sup>2</sup> - Rated current 63 A

#### 1- to 4-phases

1-phase	2	0.015	EVG-1PHAS/2MODUL	215646	40 / 800
1-phase	6	0.039	EVG-1PHAS/6MODUL	215638	40 / 800
1-phase	12	0.046	EVG-1PHAS/12MODUL	215637	40 / 400
2-phases	4	0.051	EVG-2PHAS/4MODUL	268220	20 / 400
2-phases	6	0.079	EVG-2PHAS/6MODUL	215642	20 / 400
2-phases	12	0.150	EVG-2PHAS/12MODUL	215641	20 / 200
3-phases	6	0.086	EVG-3PHAS/6MODUL	215640	20 / 400
3-phases	9	0.128	EVG-3PHAS/9MODUL	215645	20 / 200
3-phases	12	0.168	EVG-3PHAS/12MODUL	215639	20 / 200
3-phases	16	0.230	EVG-3PHAS/16MODUL	285381	20
3-phases	20	0.310	EVG-3PHAS/20MODUL	285383	20 / 180
3-phases	12	0.240	EVG-3P+3N/12MODUL	121091	20
4-phases	16	0.320	EVG-3P+3N/16MODUL	105215	20
4-phases	18	0.350	EVG-3P+3N/18MODUL	274161	20
4-phases	8	0.219	EVG-4PHAS/8MODUL	215644	10 / 100
4-phases	12	0.324	EVG-4PHAS/12MODUL	215643	10 / 100

Wa\_sg02902

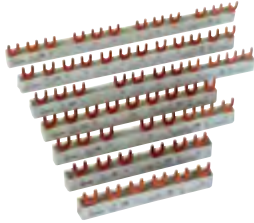

#### For 2-pole Combined RCD/MCB Device with a width of 3MU

1-phase	2-5	0.045	EVG-1PHAS/N/2-5MODUL/FILS	285384	40 / 800
---------	-----	-------	---------------------------	--------	----------

#### For combination RCD/MCBs with RCD 4-pole

3-phases	4+5	0.138	EVG-3PHAS/N/5MODUL/LS	215659	20 / 200
3-phases	4+8	0.188	EVG-3PHAS/N/8MODUL/LS	215660	20 / 200

Wa\_sg01602

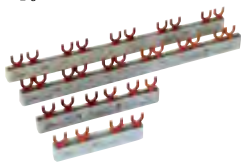

#### For applications with Auxiliary Switch

1-phase	2.5	0.008	EVG-1PHAS/2MODUL/HI	215655	40 / 200
1-phase	13	0.096	EVG-1PHAS/9MODUL/HI	215656	40
2-phases	4.5	0.015	EVG-2PHAS/4MODUL/HI	219573	20 / 400
2-phases	12	0.160	EVG-2PHAS/10MODUL/HI	215657	20
3-phases	6.5	0.100	EVG-3PHAS/6MODUL/HI	216411	20 / 200
3-phases	13.5	0.200	EVG-3PHAS/12MODUL/HI	215658	20

### 16 mm<sup>2</sup> - Rated current 80 A

#### 1- to 4-phases

1-phase	2	0.023	EVG-16/1PHAS/2MODUL	291464	40 / 800
1-phase	6	0.059	EVG-16/1PHAS/6MODUL	291465	40 / 800
1-phase	12	0.113	EVG-16/1PHAS/12MODUL	291466	40 / 400
2-phases	4	0.080	EVG-16/2PHAS/4MODUL	291467	20 / 400
2-phases	6	0.120	EVG-16/2PHAS/6MODUL	291468	20 / 400
2-phases	12	0.225	EVG-16/2PHAS/12MODUL	291469	20 / 200
3-phases	6	0.112	EVG-16/3PHAS/6MODUL	291470	20 / 400
3-phases	9	0.163	EVG-16/3PHAS/9MODUL	291471	20 / 200
3-phases	12	0.218	EVG-16/3PHAS/12MODUL	291472	20 / 200
3-phases	16	0.300	EVG-16/3PHAS/16MODUL	291473	20 / 80
3-phases	20	0.363	EVG-16/3PHAS/20MODUL	291474	10 / 100
4-phases	8	0.200	EVG-16/4PHAS/8MODUL	291475	10 / 100
4-phases	12	0.284	EVG-16/4PHAS/12MODUL	291476	10 / 100

Wa\_sg02902

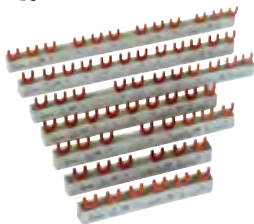

Phases	MU	Cu-factor	Type Designation	Article No.	Units per package
--------	----	-----------	------------------	-------------	-------------------

**For 2-pole Combined RCD/MCB Device with a width of 3MU**

4-phases	18	0.260	EVG-16/4PHAS/L-N-X/6PC	116880	10
4-phases	24	0.360	EVG-16/4PHAS/L-N-X/8PC	116881	10

**For combination RCD/MCBs with RCD 4-pole**

3-phases	4+5	0.179	EVG-16/3PHAS/N/5MODUL/LS	291477	20 / 200
3-phases	4+8	0.244	EVG-16/3PHAS/N/8MODUL/LS	291478	20 / 200

Wa\_sg01602

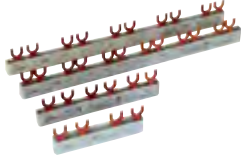

**For applications with Auxiliary Switch**

1-phase	2.5	0.038	EVG-16/1PHAS/2MODUL/HI	291479	40 / 800
1-phase	8.5	0.105	EVG-16/1PHAS/6MODUL/HI	291480	40 / 400
1-phase	13	0.162	EVG-16/1PHAS/9MODUL/HI	291481	40 / 160
2-phases	4.5	0.080	EVG-16/2PHAS/4MODUL/HI	291482	20 / 400
2-phases	7	0.120	EVG-16/2PHAS/6MODUL/HI	291483	20 / 200
2-phases	12	0.200	EVG-16/2PHAS/10MODUL/HI	291484	20 / 200
3-phases	6.5	0.130	EVG-16/3PHAS/6MODUL/HI	291485	20 / 200
3-phases	13.5	0.260	EVG-16/3PHAS/12MODUL/HI	291486	20 / 80
3x1-phase	8.5	0.231	EVG-16/3x1PHAS/6MODUL/HI	291487	20 / 200
3x1-phase	11.5	0.300	EVG-16/3x1PHAS/8MODUL/HI	291488	20 / 200
3x1-phase	13	0.344	EVG-16/3x1PHAS/9MODUL/HI	291489	20 / 80

**Description Euro-Vario-Busbar (Fork) EVG**





- Euro Vario busbars (EVG) offer maximum user comfort and a high degree of safety.
- Using EVG busbars helps to save up to 30 % assembly time as compared to conventional systems.
- The danger of flashover is minimised since there is no need of cutting, burring, or cleaning.
- No end caps are needed.

**Technical Data**

EVG	
<b>Electrical</b>	
Rated voltage	240/415 V, 50/60 Hz
Rated current	
10 mm <sup>2</sup>	63 A
16 mm <sup>2</sup>	80 A
Short-circuit current strength	25 kA
<b>Mechanical</b>	
Busbar length	2, 6, 9, 12, 16, 20 MU
Busbar cross section	10 and 16 mm <sup>2</sup> Cu
Step distance	
10 mm <sup>2</sup>	17.8 mm / 26.8 mm / 71.2 mm
16 mm <sup>2</sup>	17.8 mm / 27 mm / 71.2 mm

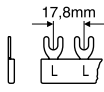
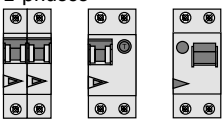

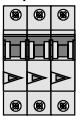
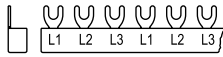
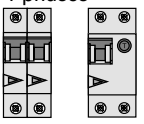
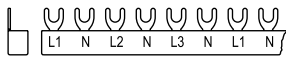
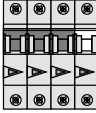
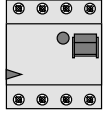
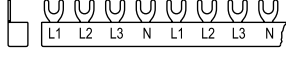
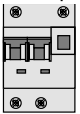
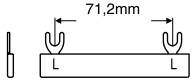
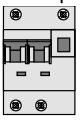
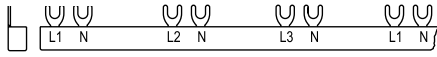
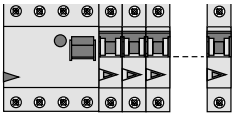
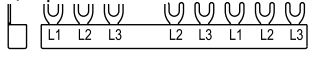
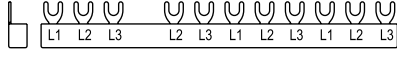
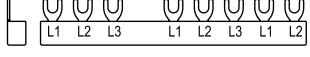
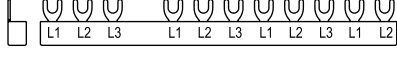
## Description of Euro-Vario-Busbar (Fork) EVG

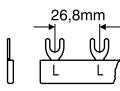
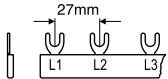
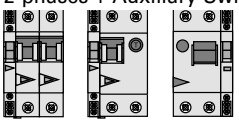
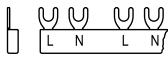
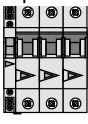
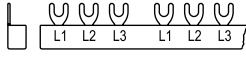
Devices to busbar	Pcs. of the devices		Type
<p>1-phase</p> 	<p>x2 x6 x12</p>		<p>EVG-../1PHAS/2MODUL EVG-../1PHAS/6MODUL EVG-../1PHAS/12MODUL</p>
<p>2-phases</p> 	<p>x2 x3 x6</p>		<p>EVG-../2PHAS/4MODUL EVG-../2PHAS/6MODUL EVG-../2PHAS/12MODUL</p>
<p>3-phases</p> 	<p>x2 x3 x4 x5 x6</p>		<p>EVG-../3PHAS/6MODUL EVG-../3PHAS/9MODUL EVG-../3PHAS/12MODUL EVG-../3PHAS/16MODUL EVG-../3PHAS/20MODUL</p>
<p>4-phases</p> 	<p>x8 x9</p>		<p>EVG-3P+3N/16MODUL EVG-3P+3N/18MODUL</p>
 	<p>x2 x3</p>		<p>EVG-../4PHAS/8MODUL EVG-../4PHAS/12MODUL</p>
<p>For 2-pole Combined RCD/MCB Device, 1-phase</p> 	<p>x2</p>		<p>EVG-1PHAS/2-5MODUL/FILES</p>
<p>For 2-pole Combined RCD/MCB Device, 4-phases</p> 	<p>x6 x8</p>		<p>EVG-16/4PHAS/L-N-X/6PC EVG-16/4PHAS/L-N-X/8PC</p>
<p>For combination RCD/MCBs with RCD 4-pole, 3-phases</p> 			<p>EVG-3PHAS/N/5MODUL/LS</p>
			<p>EVG-3PHAS/N/8MODUL/LS</p>
			<p>EVG-16/3PHAS/N/5MODUL/LS</p>
			<p>EVG-16/3PHAS/N/8MODUL/LS</p>
<p>1-phase + Auxiliary Switch</p> 	<p>x2 x6 x9</p>		<p>EVG-../1PHAS/2MODUL/HI EVG-16/1PHAS/6MODUL/HI EVG-../1PHAS/9MODUL/HI</p>
	<p>x6 x8 x9</p>		<p>EVG-16/3x1PHAS/6MODUL/HI EVG-16/3x1PHAS/8MODUL/HI EVG-16/3x1PHAS/9MODUL/HI</p>
<p>2-phases + Auxiliary Switch</p> 	<p>x2 x3 x5</p>		<p>EVG-../2PHAS/4MODUL/HI EVG-16/2PHAS/6MODUL/HI EVG-../2PHAS/10MODUL/HI</p>
<p>3-phases + Auxiliary Switch</p> 	<p>x2 x4</p>		<p>EVG-../3PHAS/6MODUL/HI EVG-../3PHAS/12MODUL/HI</p>

WA\_REN\_SG\_01622\_L, WA\_REN\_SG\_01722\_R, WA\_REN\_SG\_01822\_C

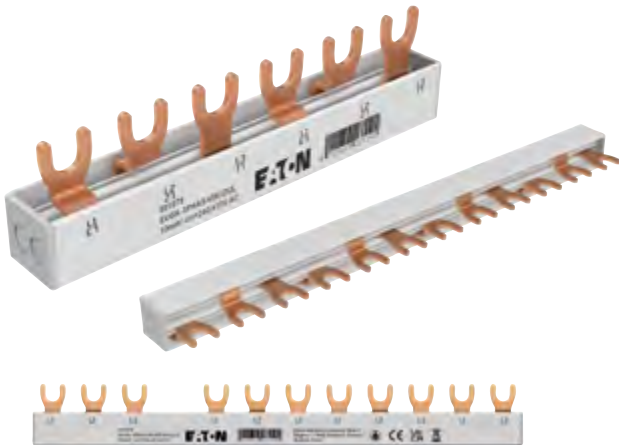

## Description

- Available in 10 mm<sup>2</sup> cross section
- Fork type
- Comes with end caps
- Busbar can be cut to desired length
- End caps can be ordered separately as replacement

Phases	MU	Cu-factor	Type Designation	Article No.	Units per package
--------	----	-----------	------------------	-------------	-------------------

### Euro-Vario-Busbar (Fork) EVGK

#### 10 mm<sup>2</sup> - Rated current 63 A

WA\_REN\_SG\_01622\_L



3-phases	6	0.026	EVGK-3PHAS/6MODUL	501075	20 / 400
3-phases	12	0.068	EVGK-3PHAS/12MODUL	501069	20 / 200

WA\_REN\_SG\_01822\_L

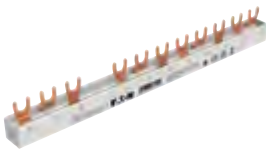

#### For combination RCD/MCBs with RCD 4-pole

3-phases	4+8	0.065	EVGK-3PHAS/N/8MODUL/LS	501070	20 / 400
----------	-----	-------	------------------------	--------	----------

Description	Type Designation	Article No.	Units per package
-------------	------------------	-------------	-------------------

### Accessories

WA\_REN\_SG\_00822\_L



End cap 3-phases (10 mm <sup>2</sup> )	EK-3/10-EVGK-GVK	501076	10 / 5000
--	------------------	--------	-----------

Description	Type Designation	Article No.	Units per package
-------------	------------------	-------------	-------------------

### Accessories

#### Busbar Tag Shrouds for busbar, yellow ZV-BS-G

SG05705



Finger and hand touch safe	ZV-BS-G	104903	10 / 600
----------------------------	---------	--------	----------

**Technical Data**

<b>EVGK</b>	
<b>General</b>	
Standards	DIN EN 61439-1:2021-10 / DIN EN 61439-6:2013-06 IEC 664 / IEC 60895-2-12 / VDE 0110 / DIN EN 60754-1
Climate stability	according to IEC 68-2
Overtoltage category	III
Pollution Degree	2
Busbar Material	E-Cu-ETP
Isolation Material	PC-ABS
Endcap Material	PC-ABS
Touch protection Material	PP
<b>Electrical</b>	
Rated operating voltage	240/415 V AC
Rated current	
10 mm <sup>2</sup>	63 A
16 mm <sup>2</sup>	80 A
Short-circuit current strength	25 kA /100 A gI
Disruptive Strength	36 kV/mm
Surge Voltage	$U_{imp}$ 4 kV
<b>Mechanical</b>	
Busbar cross section	10 mm <sup>2</sup>
Step distance	17.8 mm

**Feeding**

Side Feeding

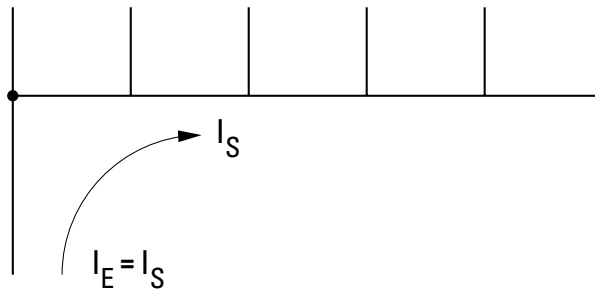

Central Feeding

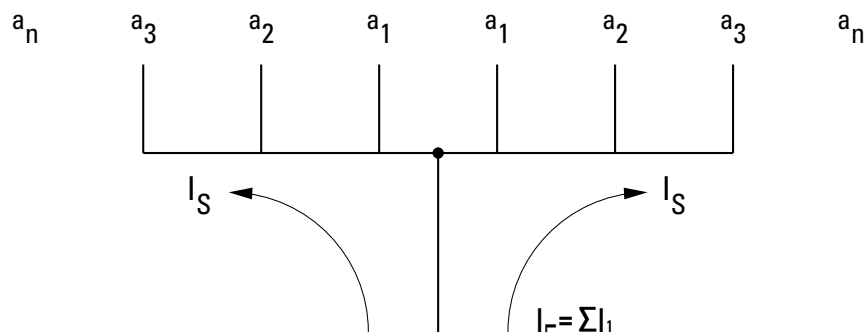

Using central supply feeding you must be sure that the sum of the output current depending on  $a_1 \dots a_n$  of each busbar part is not greater than the above max. busbar current  $I_s$  / phase

## Connection diagram

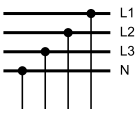

## Description Graphics

Devices to busbar	Pcs. of the devices	End caps		Type
<p>3-phases</p>	x2	EK-3/10-EVGK-GVK		EVGK-3PHAS/6MODUL
	x4			EVGK-3PHAS/12MODUL
<p>For combination of RCD/MCBs. 4+8 MU</p>		EK-3/10-EVGK-GVK		EVGK-3PHAS/N/8MODUL/LS

## Dimensions (mm)

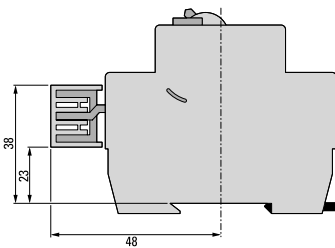

**End Cap dimensions (mm)**

EK-3/10-EVGK-GVK

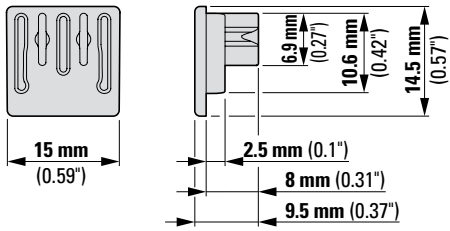

EK-3/16-EVGK-GVK

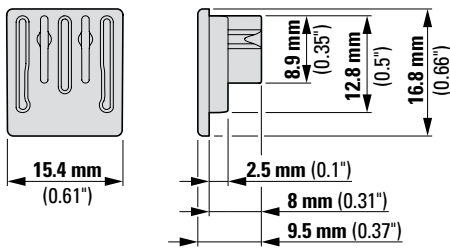

EK-3N/16-EVGK-GVK

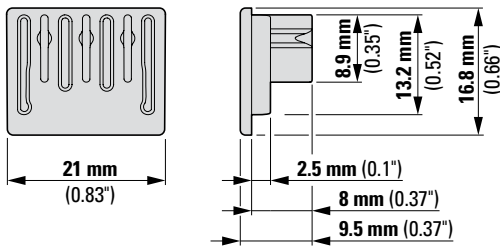

**Dimensions (mm)**

EVGK-3PHAS/6MODUL

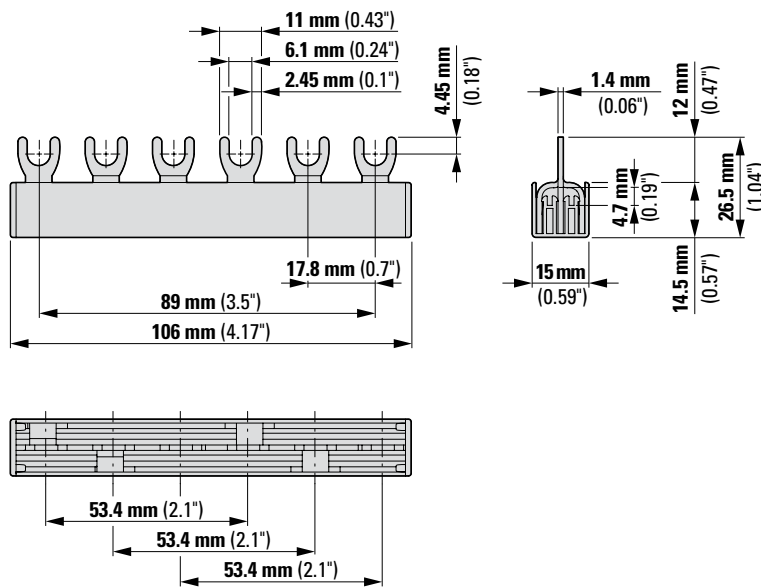

## Dimensions (mm)

EVGK-3PHAS/8MODUL/LS

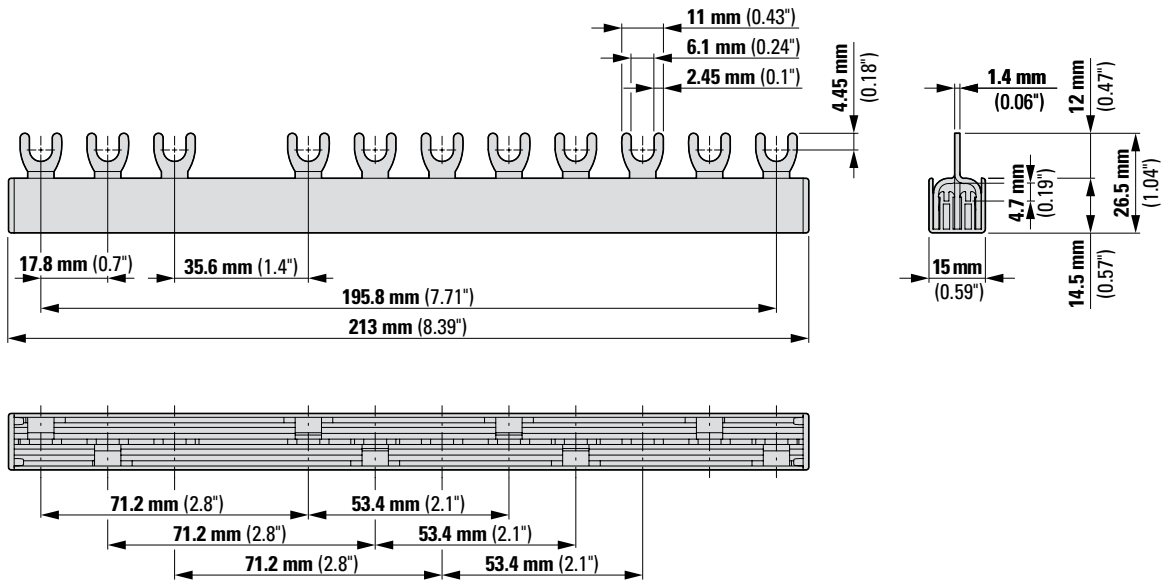

EVGK-3PHAS/12MODUL

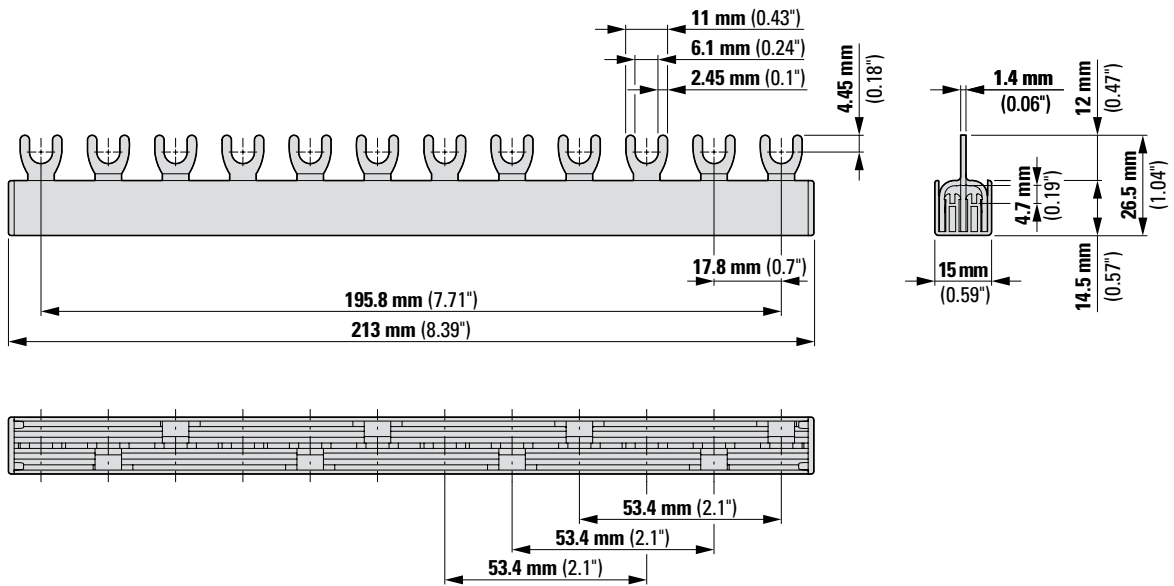

wa\_sg02616





Description	Type Designation	Article No.	Units per package
<b>Vertical Busbar 16mm<sup>2</sup> BB-V-16/1P+N</b>			
2-phases	BB-V-16/1P+N	186887	5

wa\_sg02616



### Description Vertical Busbar 16mm<sup>2</sup> BB-V-16/1P+N

**Attention:**

The thermal overload protection for the RCCB installing next to the vertical busbar must be considered (please refer to our catalogue register RCCB

$I_n = 16A$  RCCB  $\Rightarrow$  10 A gG/gL Fuse/Main Incomer

$I_n = 25-40A$  RCCB  $\Rightarrow$  25 A gG/g Fuse/Main Incomer

$I_n = 63A$  RCCB  $\Rightarrow$  40 A gG/gL Fuse/Main Incomer

or country specific wiring regulations).

The thermal emission from the vertical busbar can affect the tripping characteristics of the neighboring RCDs, please follow notes in our product documentation regarding possible temperature derating.

Thermal overload protection for the vertical busbar according to EN61439-3 must be considered  $\Rightarrow$  nominal current 80A, max. 84A for 15 minutes, maximum setting for ELCB NF: 60A.



Products are EU conform and correspond to the RoHS of the EU

### Technical Data

		BB-V-16/1P+N
<b>General</b>		
Busbar		Copper
Surface busbar		plain
Insulation		PA66
Surface insulation		grey RAL 7035
Standards		EN 60947-1:2007 / IEC 60947-1:2007
Temperature resistance		125 °C – UL94 V0
CTI Insulation		600 V
Insulation coordination		Overvoltage category III / Pollution degree 2
<b>Electrical</b>		
Max. electrical load		690 V AC
Protection class		IP20
Rated peak withstand voltage	$U_{imp}$	6 kV
Rated insulation voltage	$U_i$	800 V
<b>Capacity at 35 °C ambient temperature</b>		
Max. current with bar cross section 16 mm <sup>2</sup>	$I_g$ /Phase	80 A

### Dimensions (mm)

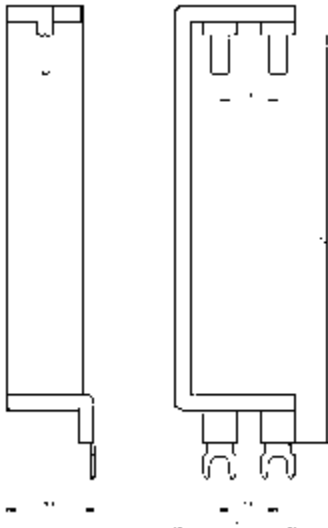

sg05517



Phases	Cu-factor	Type Designation	Article No.	Units per package
2-phase	0.114	EVG-2PHAS/4AFDD	193378	10



## Technical Data



Products are EU conform and correspond to the RoHS of the EU

EVG-2PHAS/4AFDD	
<b>General</b>	
Busbar	Copper
Surface busbar	plain
Insulation	PC/ABS
Surface insulation	grey
Standards	EN 60947-1:2007 / IEC 60947-1:2007
Heat deflection temperature	90 °C – UL94 V0
Glow Wire Flammability Index	960 °C / 1 mm
Insulation coordination	Overvoltage category III / Pollution degree 2
<b>Electrical</b>	
Max. operating voltage	690 V AC/DC
Protection class	IP20
Rated impulse withstand voltage	$U_{imp} \geq 4,5 \text{ kV}$
Max. operating voltage	690 V IEC
1-, 3-phase	480Y/277V & 240 V AC
<b>Load Capacity at 35 °C ambient temperature depending of feeding point</b>	
Max. busbar current feeding at beginning / ending	$I_g/\text{Phase}$ 50 A
Busbar cross section	10 mm <sup>2</sup>
Connection cross section	10 mm <sup>2</sup>

## Dimensions (mm)

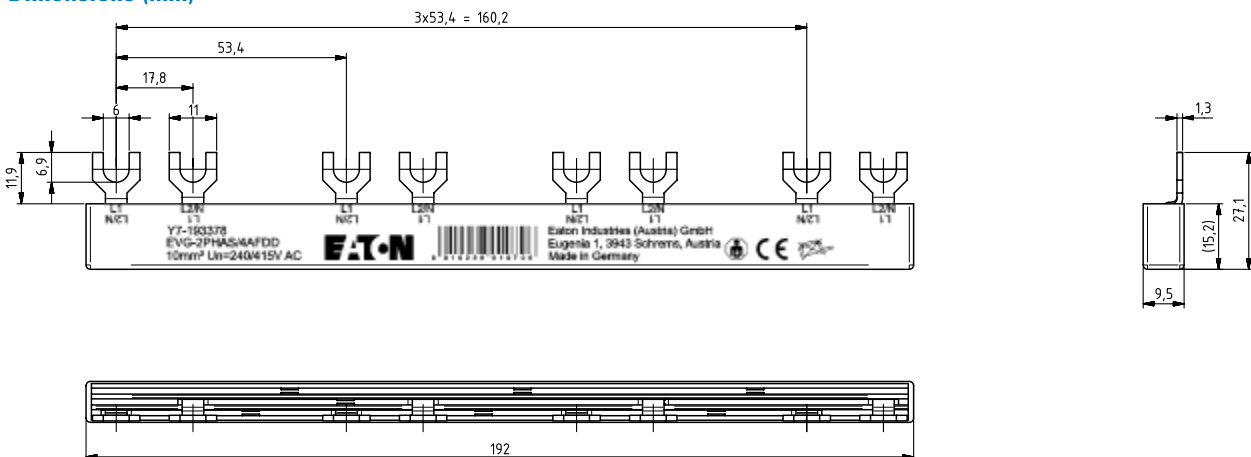

Description	Type Designation	Article No.	Units per package
-------------	------------------	-------------	-------------------

**Busbar for auxiliary contact**

sg00121, sg00221, sg00621

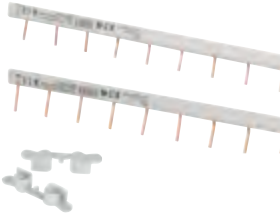

4 mm <sup>2</sup>			
Short pin	Z-VPS-4/1p+HS	302375	20/200
Long pin	Z-VPL-4/1p+HS	302376	20/200
End cap	Z-VP-AK/1p	302377	10/500

**Description Busbar 4 mm<sup>2</sup>**



Products are CE conform and correspond to the RoHS of the EU

**Technical Data**

Z-VPS / Z-VPL	
<b>General</b>	
Busbar	Copper
Surface busbar	plain
Insulation	PC/ABS
Surface insulation	grey
Standards	EN 60947-1:2007 / IEC 60947-1:2007
Heat deflection temperature	90 °C flame-retardant
Comparative Tracking Index	PLC 1
Insulation coordination	Overvoltage category III / Pollution degree 2
<b>Electrical</b>	
Max. operating voltage	1000 V AC / 1500V DC
Protection class	IP20

**Load Capacity at 35 °C ambient temperature depending of feeding point**

Max. busbar current feeding at beginning / ending	I <sub>s</sub> /Phase 32 A
Busbar cross section	4 mm <sup>2</sup>

**Dimensions (mm)**

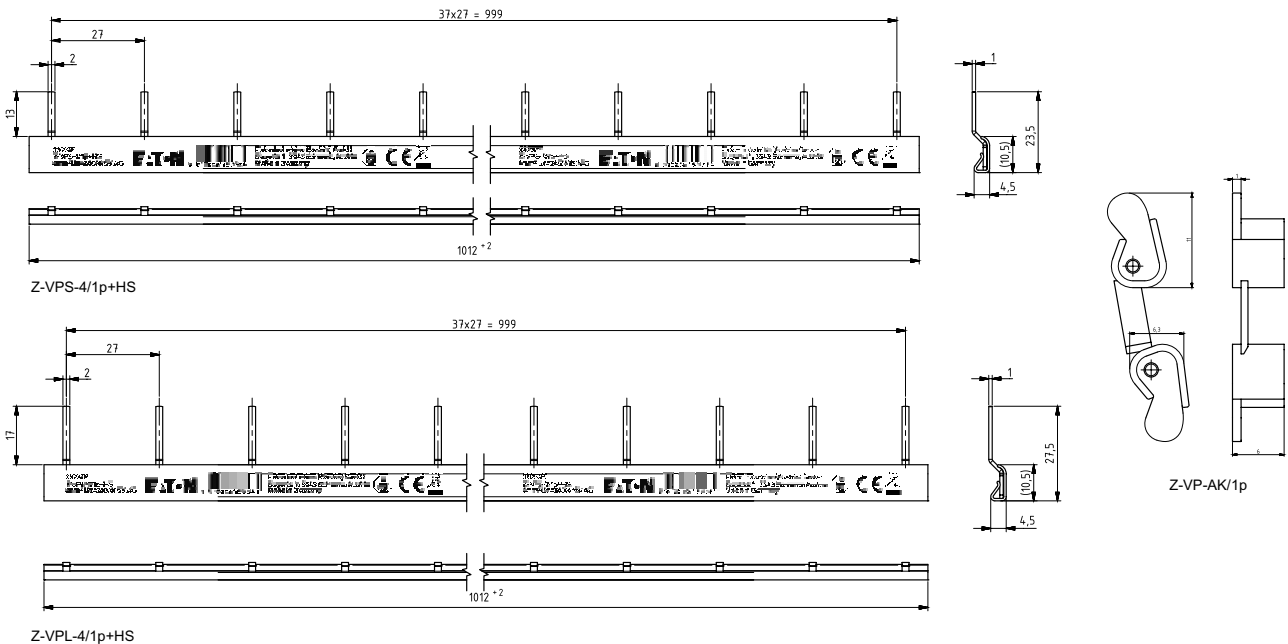

# 1.144 Busbar Systems

Busbar Z-VPS, Z-VPL for auxiliary contact

## Connection examples

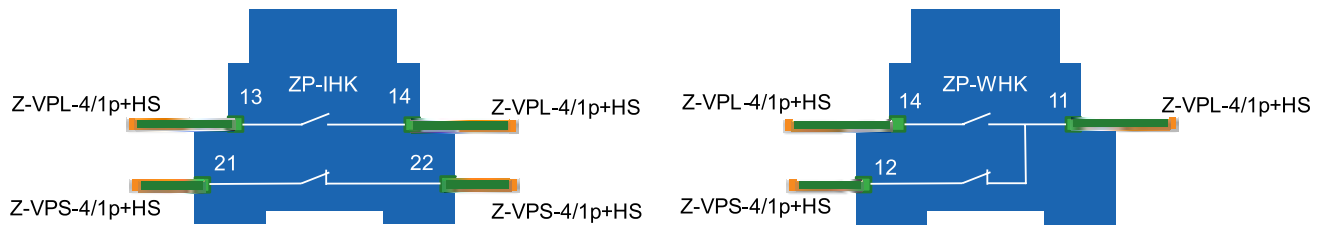

Phases	Cu-factor	Type Designation	Article No.	Units per package
--------	-----------	------------------	-------------	-------------------

**Busbar EVG-3PHAS/N/6MODUL/LS**

sg00321



<b>10 mm<sup>2</sup>, 16 mm<sup>2</sup>, 25 mm<sup>2</sup></b>				
3-phases		EVG-3PHAS/N/6MODUL/LS	303366	10

**Description Busbar EVG-3PHAS/N/6/MODUL/LS**



Products are EU conform and correspond to the RoHS of the EU

**Technical Data**

<b>EVG3/PHAS/N/6/MODUL/LS</b>	
<b>General</b>	
Busbar	Copper
Surface busbar	plain
Insulation	PC/ABS
Surface insulation	grey
Standards	EN 60947-1:2007 / IEC 60947-1:2007
Temperature resistance	90 °C flammgeschützt
CTI Insulation	300 V
Insulation coordination	Overvoltage category III / Pollution degree 2
<b>Electrical</b>	
Impulse voltage strenght	≥ 4.5 kV
Min. air distance	> 5.5 mm
Min. creeping distance	> 5 mm
Max. operating voltage	1Ph: 1000V AC/DC 2Ph-4Ph : 690 V AC/DC
Protection class	IP20
Short circuit rating	ICC 15 kA - NH3 250 A gC500V JM
Dielectric strenght	> 32 kV / mm

**Load Capacity at 35 °C ambient temperature depending of feeding point**

Busbar cross section	10 mm <sup>2</sup>	16 mm <sup>2</sup>	25 mm <sup>2</sup>
Feeding at beginning / ending			
Max. busbar current I <sub>g</sub> /Phase	63 A	80 A	100 A
Connection cross section mm <sup>2</sup>	10 mm <sup>2</sup>	16 mm <sup>2</sup>	25 mm <sup>2</sup>

## Dimensions (mm)

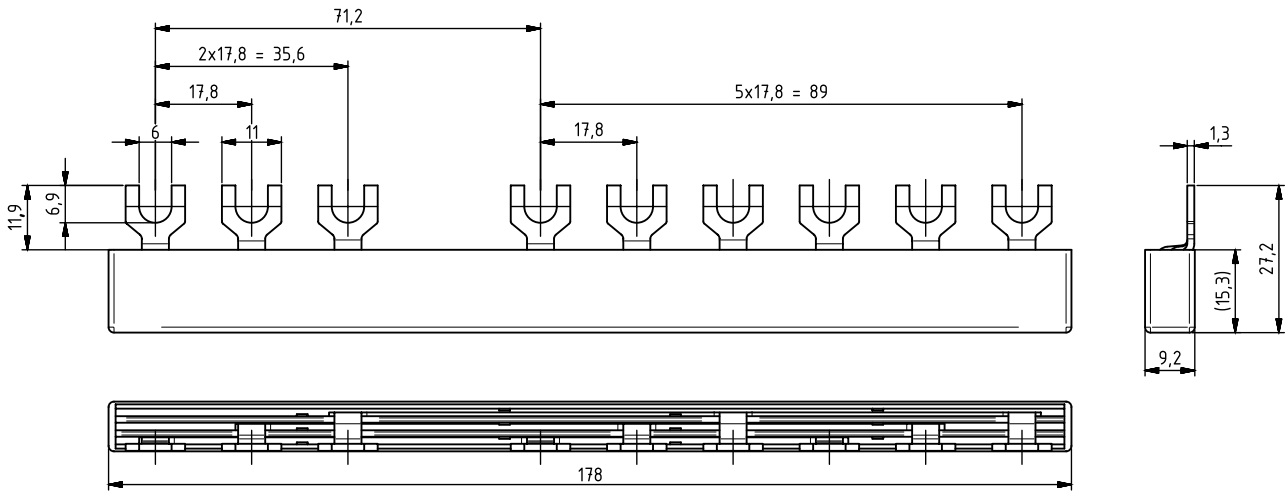

Poles	Type Designation	Article No.	Units per package
-------	------------------	-------------	-------------------

**Row-connectors-system for compact distribution boards with 125 mm row spacing**

SG3197



1	RVS-1PHAS/125	215610	3
N	RVS-1N/125	215612	3
1+N	RVS-1PHAS+N/125	215615	3
3	RVS-3PHAS/125	215617	3
3+N	RVS-3PHAS+N/125	215620	3

**Row-connectors-system for distribution boards with 150 mm row spacing**

SG3097



1	RVS-1PHAS/150	215611	3
N	RVS-1N/150	215613	3
1+N	RVS-1PHAS+N/150	216410	3
3	RVS-3PHAS/150	215618	3
3+N	RVS-3PHAS+N/150	215621	3

**Row-connectors-system for connections across 2 rows with 125 mm row spacing**

SG3297

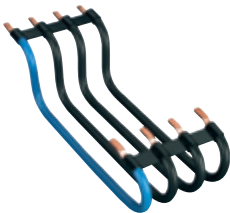

1	RVS-1PHAS/250	216409	3
N	RVS-1N/250	215614	3
1+N	RVS-1PHAS+N/250	215616	3
3	RVS-3PHAS/250	215619	3
3+N	RVS-3PHAS+N/250	215622	3

**Specification | Rigid Row Connectors**

**Description**

The row connectors offer the greatest possible application comfort with the highest level of safety. The use of the row connectors results in a large saving of assembly time compared to conventional systems.

The rigid row connectors are used for the safe distribution of phases to several DIN rail rows. Thanks to the flattened connection pieces, two rigid wiring bridges can be fed into one lift terminal at the same time.

The row connectors can be folded up between the individual phases thanks to the flexible retaining bridges and can therefore also be used in extremely flat distribution boards.

If required, the row connectors can also be easily separated at these distance holders.

**Technical Data**

	RVS
<b>Electrical</b>	
Standards and regulations	IEC 60664
Rated voltage	max. 500 V
Capacity	max. 120 A
Short circuit rating	25 kA
<b>Mechanical</b>	
Length	125, 150, 250 mm
Phase indication labels available	Phase black, N-conductor blue, earth conductor yellow/green
Conductor material	Copper
Terminal protection	finger and hand touch safe according to DGUV VS3, EN 50274
Ambient temperature	-20°C to +40°C
Resistance to climatic conditions	according to IEC 60068



## Dimensions (mm)

RVS-3PHAS/125

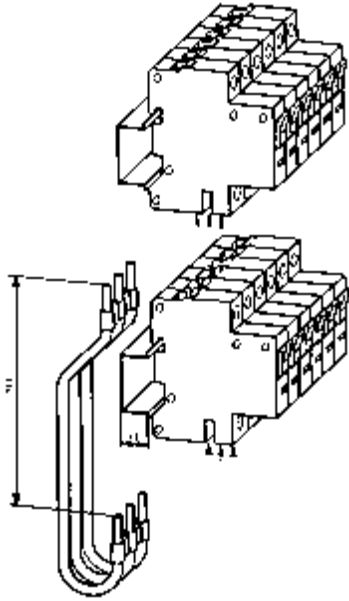

RVS-3PHAS/250

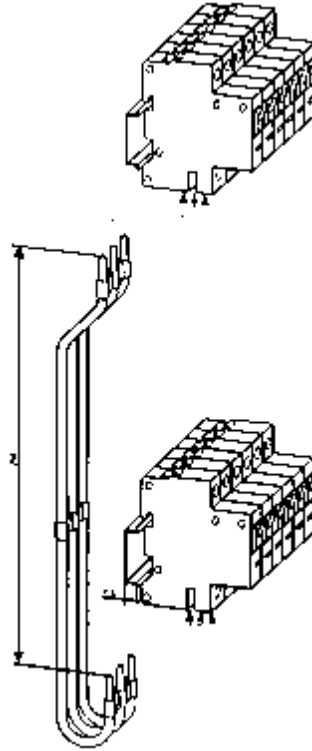

SG80911



**Mounting**

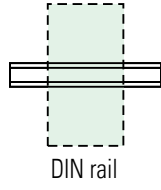

**Frame**

- D0** D0 Fuse-Bases
- D0** D0 Switch-Disconnectors
- C** Cylindrical Switch-Disconnectors

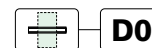

Rated current (A)	Poles	Width (mm)	Type Designation	Article No.	Units per package
-------------------	-------	------------	------------------	-------------	-------------------

### Fuse-Base D01+D02

#### Fuse-Base FCFBD02DI

- One design for Fuse-Links size D02 and D01, because adapter springs for screw caps D02 are in scope of delivery
- Only screw cap D02 for all applications necessary
- Mounting on DIN-rail or mounting plate possible
- Finger and hand touch safe according to DGUV VS3, EN 50274
- Fuse-Base is equipped with holes for sealing

SG80211



63	1	27	FCFBD02DI-1	148599	15
63	3	81	FCFBD02DI-3	148810	5

Description	Type Designation	Article No.	Units per package
-------------	------------------	-------------	-------------------

### Screw Caps Z-D0./SK

wa\_sg04013



D01 max. 16 A	Z-D01/SK	100650	20
D02 max. 63 A	Z-D02/SK	100651	20

### Adapter Spring Z-D02/SIKA-HF

- To apply D01-Fuse-Links into the screw cap Z-D02/SK

wa\_sg02612



D02-D01	Z-D02/SIKA-HF	263149	50 / 3000
---------	---------------	--------	-----------

### Accessories for FCFBD02DI-

Fuse-Links Z-D0./SE-...

Cartridge-ring adapter inserts Z-D02-PE-... and Z-D02-D01-PE-...

Adapter Spring Z-D02/SIKA-HF (scope of delivery)

Cartridge-ring adapter insert plier Z-D0-PE-Zsee chapter Accessories Fuse Devices.

For busbar blocks and feed terminals refer to fuse-switch-disconnector and busbar systems.

### Description Fuse-Base FCFBD02DI

- According to DIN VDE 0636-301
- For Fuse-Links size D02 and D01
- Can be sealed with leads
- Silicone-, halogen- and phosphorfree
- Cartridge-ring adapter inserts Z-D02-PE and Z-D02-D01-PE required for current coding
- Low-loss stainless steel terminal (anti-magnetic)



**Technical Data**

<b>FCFBD02DI</b>	
<b>Electrical</b>	
Number of poles	1P, 3P
Rated voltage	400 V AC, 250 V DC
Rated current	
D01	16 A
D02	63 A
Conditional rated short circuit current tested with inserts Operating class gG (gL)	
AC	50 kA
DC	8 kA
Short-circuit current strength	25 kA
<b>Mechanical</b>	
Frame size	45 mm
Device height	68 mm
Device width	27 mm per pole
Weight	
1P	74 g
3P	213 g
Mounting	Quick fastening on DIN rail according to IEC/EN 60715 Screw fastening on mounting plate screw $\leq 4$ mm, head $\leq 7$ mm
Upper and lower terminals	lift terminals
Terminal capacity	1.5-35 mm <sup>2</sup>
Tightening torque of terminal screws	3.5 Nm
Flame class according to UL94	V0
Comparative tracking index	CTI 600

**Dimensions (mm)**

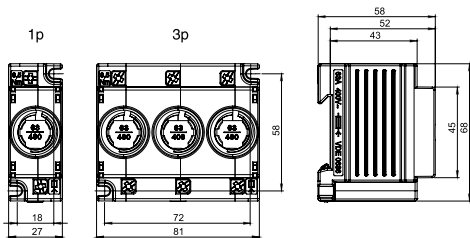

**Operation position**

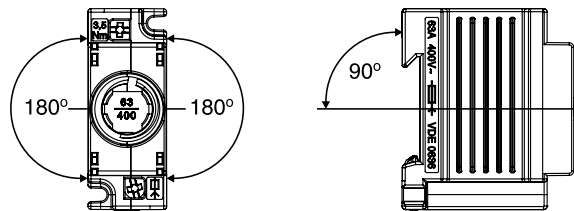

**Examples**

3-phases **16 mm<sup>2</sup>**

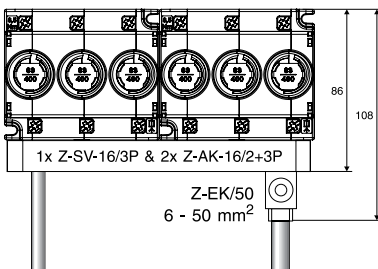

**Terminal capacity Z-EK/95, Z-EK/95-1:**  
25-95 mm<sup>2</sup> single-fine-wire  
16-70 mm<sup>2</sup> fine wires with wire end sleeve

3-phases **35 mm<sup>2</sup>**

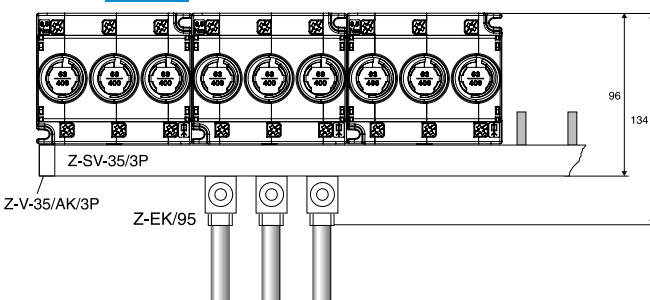

1-phase **35 mm<sup>2</sup>**

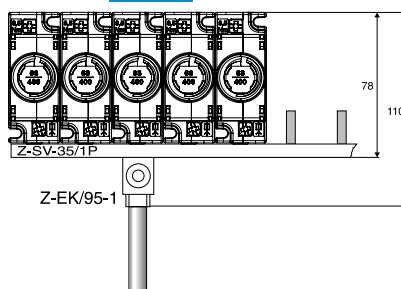



Poles	Rated constant current (A)	Type Designation	Article No.	Units per package
-------	----------------------------	------------------	-------------	-------------------

#### Switch-Disconnecter-Fuse D01

##### With visual tripping indicator Z-SLS/D01 (empty)

- Rated operational voltage 230/400 V AC  
1-pole 60 V DC, 2-pole 110 V DC
- Suitable for fuse-links with operating classes gG (gL), aM
- Mechanical current coding is integrated
- Can be sealed with leads
- Supply side from top or bottom

SG80411



1	max. 16	Z-SLS/D01/1	263155	18
1+N	max. 16	Z-SLS/D01/1+N	263158	9
2	max. 16	Z-SLS/D01/2	263156	9
3	max. 16	Z-SLS/D01/3	263157	6
3+N	max. 16	Z-SLS/D01/3+N	263159	4

#### Accessories

Fuse-Links Z-D01/SE-...see chapter Accessories Fuse Devices

#### Description Switch-Disconnecter-Fuse D01

- Design according to IEC/EN 60947-3
- Mechanical current coding by means of integrated, adjustable coding ring
- Plug-in technology without screw caps
- Visual tripping indicator is flashing
- Suitable for the following fuse-links  
D01: 2, 4, 6, 10, 16 A

#### Connection diagram

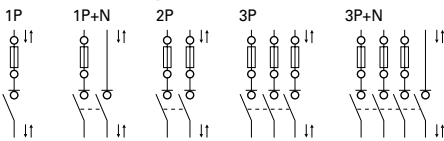

#### Dimensions (mm)

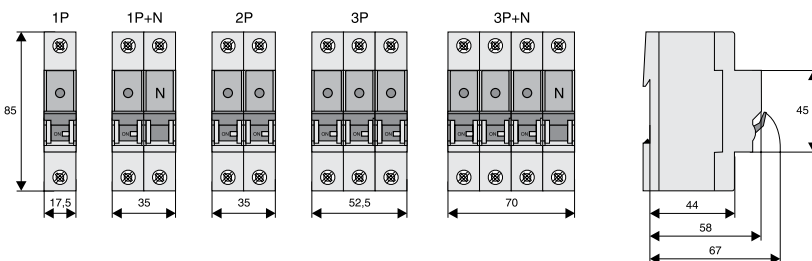



**Technical Data**

		Z-SLS/D01
<b>Electrical</b>		
Number of poles		1P, 1P+N, 2P, 3P, 3P+N
Rated operational voltage	$U_e$	
AC		400 V
DC		1P to 60 V / 2P to 110 V
Rated operational current	$I_e$	16 A
Rated constant current	$I_u$	16 A
Conditional rated short circuit current		50 kA <sub>r.m.s.</sub>
Utilization category		AC 22B, DC 21B
Overvoltage category		IV
Rated peak withstand voltage	$U_{imp}$	6 kV
Power loss per current path $I_e$		0.64 W
Power loss per current path with fuse-link $I_e$		2.24 W
<b>Mechanical</b>		
Frame size		45 mm
Device height		86 mm
Device width		17.5 mm per pole (1MU)
Weight		
1P		90 g
1P+N		170 g
2P		180 g
3P		270 g
3P+N		350 g
Mounting		Quick fastening on DIN rail according to IEC/EN 60715
Degree of protection		IP20
Upper and lower terminals		lift terminals
Terminal capacity		1.5-25 mm <sup>2</sup>
Tightening torque of terminal screws		max. 2.5 Nm
Temperature range		-25 to +60 °C
Flame class		V0, glowing wire test 960 °C
Pollution degree		3
Comparative tracking index		CTI 600

**Examples**

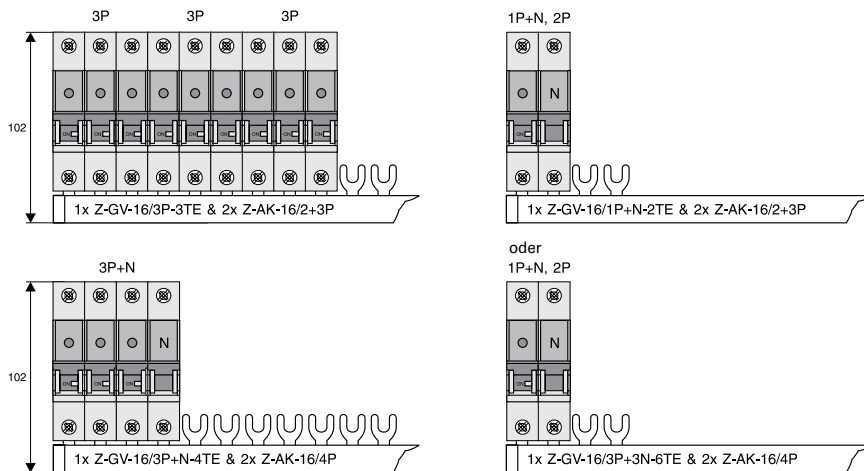

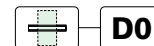

Poles	Rated constant current (A)	Type Designation	Article No.	Units per package
-------	----------------------------	------------------	-------------	-------------------

### Fuse-Switch-Disconnecter D02+D01

#### Standard Z-SLS/NEOZ (empty)

- Rated operational voltage 1-pole 230 V AC / 110 V DC  
2-pole 400 V AC / 250 V DC  
1+N, 3-pole, 3+N, 3+PEN 400 V AC
- Suitable for fuse-links with operating classes gG (gL), aM
- Mechanical current coding with Fuse-Link set
- Can be sealed with leads
- Supply side from top or bottom

SG80611



1	max. 63	Z-SLS/NEOZ/1	248235	12
1+N	max. 63	Z-SLS/NEOZ/1+N	248237	6
2	max. 63	Z-SLS/NEOZ/2	248233	6
3	max. 63	Z-SLS/NEOZ/3	248234	4
3+N	max. 63	Z-SLS/NEOZ/3+N	248236	3
3+PEN	max. 63	Z-SLS/NEOZ/3+PEN	182399	3

### Accessories

- Metal locking device for 1-pole Z-SLZ/SC
- Plastic locking device for 1-pole Z-SLZ/SP
- Fuse-Link set with visual tripping indicator Z-SLS/B-..
- Plug-in Busbars ...

### Description Fuse-Switch-Disconnecter Z-SLS/NEOZ, Standard

- Design according to IEC/EN 60947-3
- Mechanical current coding
- Plug-in technology without screw caps
- Suitable for the following fuse-links  
D01: 1, 2, 4, 6, 10, 13, 16 A  
D02: 20, 25, 32, 35, 40, 50, 63 A
- Can be sealed with leads

### Connection diagram

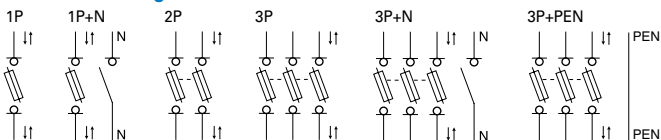



**Technical Data**

		<b>Z-SLS/NEOZ</b>
<b>Electrical</b>		
Number of poles		1P, 1P+N, 2P, 3P, 3P+N
Rated operational voltage	$U_e$	
AC 1P, 1P+N		230 V
2P, 3P, 3P+N		400 V
DC 1P		bis 110 V
2P		bis 250 V
Rated operational current	$I_e$	63 A
Rated constant current	$I_u$	63 A
Conditional rated short circuit current		50 kA <sub>r.m.s.</sub>
Utilization category		AC 22B/400V/63A, DC 21B/110V/63A per pole
Overvoltage category		IV
Rated peak withstand voltage	$U_{imp}$	6 kV
Power loss per current path $I_e$		
L1, L2, L3		0.5 W
N		1 W
Power loss per current path with fuse-link $I_e$ L1, L2, L3		6.6 W
Max. permissible power loss of fuse-links		5.5 W
<b>Mechanical</b>		
Frame size		45 mm
Device height		86 mm
Device width		27 mm per pole (1.5MU)
Weight		
1P		113 g
1P+N		225 g
2P		224 g
3P		450 g
3P+N		472 g
Mounting		Quick fastening on DIN rail according to IEC/EN 60715
Degree of protection (behind front plate)		IP20C
Upper and lower terminals		lift terminals
Terminal capacity		1.5-35 mm <sup>2</sup>
Tightening torque of terminal screws		max. 4 Nm
Temperature range		
Ambient air		-25 to +40 °C, on 24h average ≤+35 °C
Storage		-25 to +60 °C
Temperature rise limits		
Terminals		≤+70 °K
Manual operating means		≤+25 °K
Parts intended to be touched		≤+40 °K
Parts need not to be touched		≤+50 °K
Flame class		V0, glowing wire test 960 °C
Pollution degree		3
Comparative tracking index		CTI 600

**Dimensions (mm)**

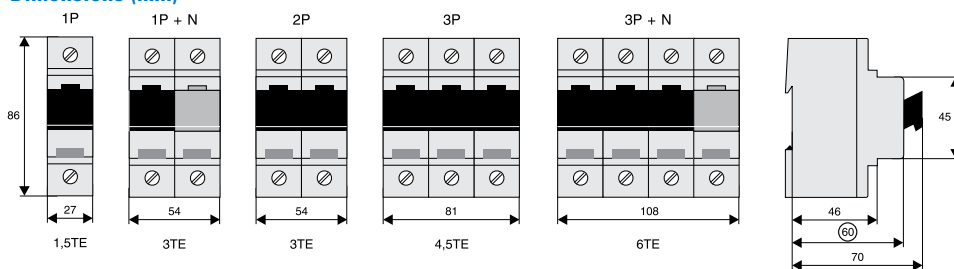



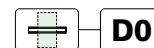

### Examples

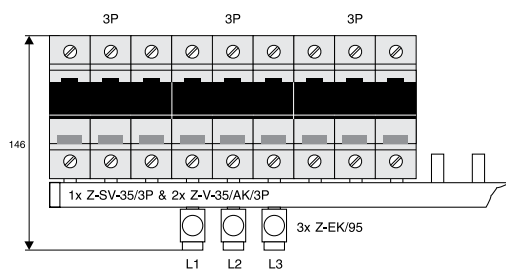

Terminal capacity  
25 - 95 mm<sup>2</sup>

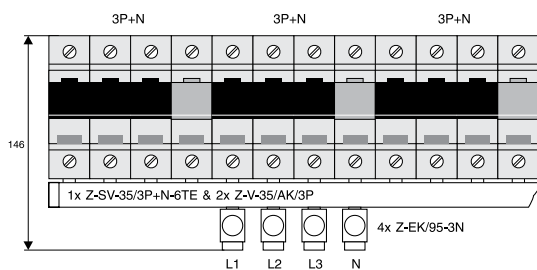

Terminal capacity  
25 - 95 mm<sup>2</sup>

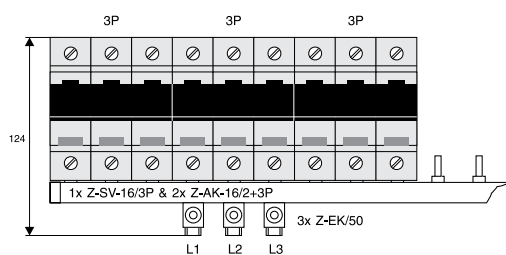

Terminal capacity  
6 - 50 mm<sup>2</sup>

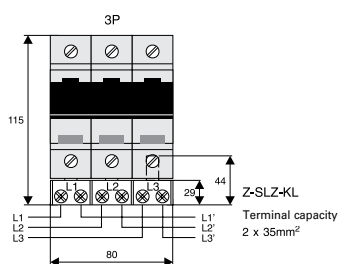



Poles	Rated constant current (A)	Type Designation	Article No.	Units per package
-------	----------------------------	------------------	-------------	-------------------

**Fuse-Switch-Disconnecter D02+D01**

**Complete with captive current code Z-SLS/CEK**

- Rated operational voltage 1-pole 50-230 V AC / 50 - 110 V DC  
3-pole 50-400 V AC
- Fuse carrier with visual tripping indicator and fuses inclusive
- Mechanical current coding with Fuse-Link set
- Can be sealed with leads
- Supply side from top or bottom

SG80711



1pole	10	Z-SLS/CEK10/1	272587	12
1pole	16	Z-SLS/CEK16/1	263135	12
1pole	25	Z-SLS/CEK25/1	263136	12
3pole	16	Z-SLS/CEK16/3	248243	4
3pole	25	Z-SLS/CEK25/3	248244	4
3pole	35	Z-SLS/CEK35/3	248245	4
3pole	40	Z-SLS/CEK40/3	150687	4
3pole	50	Z-SLS/CEK50/3	248246	4
3pole	63	Z-SLS/CEK63/3	263160	4

**Accessories**

- Metal locking device for 1-pole Z-SLZ/SC
- Plastic locking device for 1-pole Z-SLZ/SP
- Fuse-Link set with visual tripping indicator Z-SLS/B-..
- Plug-in Busbars ...

**Description Fuse-Switch-Disconnecter Z-SLS/CEK, complete with captive current code**

- Design according to IEC/EN 60947-3
- Can be used as main fuse downstream of the meter according to the Technical Connection Rules of the Austrian Power Supply Companies („TAEV“)
- Current coding by the manufacturer
- Plug-in technology without screw caps
- Suitable for the following fuse-links  
D01: 10, 16 A  
D02: 25, 35, 40, 50, 63 A
- Can be sealed with leads
- Visual tripping indicator included

**Connection diagram**

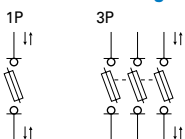

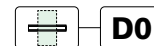

#### Technical Data

		Z-SLS/CEK
<b>Electrical</b>		
Number of poles		1P, 3P
Rated operational voltage	$U_e$	50-230 V AC / 50-110 V DC
1P		50-400 V AC
3P		
Rated constant current	$I_u$	
1P		10, 16, 25 A
3P		16, 25, 35, 40, 50, 63 A
Conditional rated short circuit current		50 kA <sub>r.m.s.</sub>
Utilization category		AC 22B/400V/63A, DC 21B/110V/63A per pole
Overvoltage category		IV
Rated peak withstand voltage	$U_{imp}$	6 kV
Power loss per current path at 63A L1, L2, L3		0.5 W
Power loss per current path		
with fuse-link		L1, L2, L3
10 A		2.0 W
16 A		2.5 W
25 A		3.7 W
35 A		4.3 W
40 A		5.2 W
50 A		5.7 W
63 A		6.6 W
Max. permissible power loss of fuse-links		5.5 W
<b>Mechanical</b>		
Frame size		45 mm
Device height		86 mm
Device width		27mm per pole (1.5MU)
Weight		
1P		147 g
3P		441 g
Mounting		Quick fastening on DIN rail according to IEC/EN 60715
Degree of protection (behind front plate)		IP20C
Upper and lower terminals		lift terminals
Terminal capacity		1.5-35 mm <sup>2</sup>
Tightening torque of terminal screws		max. 4 Nm
Temperature range		
Ambient air		-25 to +40 °C, on 24h average ≤+35 °C
Storage		-25 to +60 °C
Temperature rise limits		
Terminals		≤+70 °K
Manual operating means		≤+25 °K
Parts intended to be touched		≤+40 °K
Parts need not to be touched		≤+50 °K
Flame class		V0, glowing wire test 960 °C
Pollution degree		3
Comparative tracking index		CTI 600

#### Dimensions (mm)

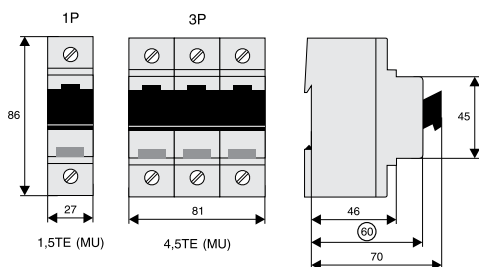



Example

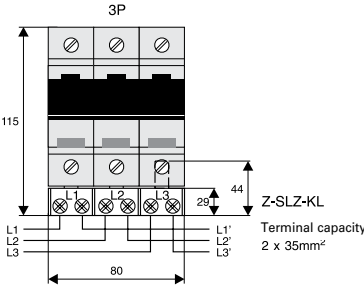



Poles	Rated constant current (A)	Type Designation	Article No.	Units per package
-------	----------------------------	------------------	-------------	-------------------

### Fuse-Switch-Disconnecter D02+D01

#### With fuse monitoring Z-SLK/NEOZ (empty)

- Rated operational voltage 1-pole 50-230 V AC / 50-110 V DC  
2-pole 50-400 V AC / 50-250 V DC  
3-pole, 3+N 50-400 V AC
- Mechanical current coding with Fuse-Link set
- Can be sealed with leads
- Supply side from top or bottom

SG80911



1+HS	max. 63	Z-SLK/NEOZ/1	248238	6
2+HS	max. 63	Z-SLK/NEOZ/2	248239	4
3+HS	max. 63	Z-SLK/NEOZ/3	248240	3
3+N+HS	max. 63	Z-SLK/NEOZ/3+N	248241	2

### Accessories

- Metal locking device for 1-pole Z-SLZ/SC
- Plastic locking device for 1-pole Z-SLZ/SP
- Fuse-Link set with visual tripping indicator Z-SLS/B-..
- Plug-in Busbars ...

### Description Fuse-Switch-Disconnecter Z-SLK/NEOZ, with fuse monitoring

- Design according to IEC/EN 60947-3
- Fuse monitoring by relay contact
- Mechanical current coding
- Plug-in technology without screw caps
- Suitable for the following fuse-links  
D01: 1, 2, 4, 6, 10, 13, 16 A  
D02: 20, 25, 32, 35, 40, 50, 63 A
- Can be sealed with leads
- Other AC/DC voltages requires special types

### Connection diagram

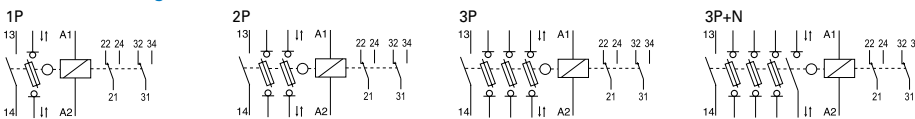



## Technical Data

		Z-SLK/NEOZ
<b>Electrical</b>		
Number of poles		1P, 2P, 3P, 3P+N
Rated operational voltage	$U_e$	
AC 1P		50-230 V AC
2P, 3P, 3P+N		50-400 V
DC 1P		50-110 V DC
2P		50-250 V
Rated operational current	$I_e$	63 A
Rated constant current	$I_u$	63 A
Conditional rated short circuit current		50 kA <sub>r.m.s.</sub>
Utilization category		AC 22B/400V/63A, DC 21B/110V/63A per pole
Overvoltage category		IV
Rated peak withstand voltage	$U_{imp}$	6 kV
Power loss per current path $I_e$		
L1, L2, L3		0.5 W
N		1 W
Power loss per current path with fuse-link $I_e$ L1, L2, L3		6.6 W
Max. permissible power loss of fuse-links		5.5 W
Auxiliary Switch 1 NO		5 A / 250 V AC
<b>Relay Component electrical components</b>		
Rated operational voltage range		24-250 V AC/DC
Rated operational voltage tolerance		±10%
Power consumption		1.25 VA
Frequency		DC (0Hz) 50-60 Hz
Function display		
Line voltage		1 LED green
Trouble		1 LED red
Duty		100%
Responding delay		approx. 100 ms - 1 s
Reset time		1 s
Relay contacts		2 CO, 5 A / 250 V AC
Auxiliary switch rated impulse withstand voltage		4 kV
Overvoltage category		III
<b>Mechanical</b>		
Frame size		45 mm
Device height		86 mm
Device width		27 mm/pole (1.5MU) + 27 mm
Weight		
1P		224 g
2P		345 g
3P		450 g
3P+N		590 g
Mounting		Quick fastening on DIN rail according to IEC/EN 60715
Degree of protection (behind front plate)		IP20C
Upper and lower terminals		lift terminals
Terminal capacity		1.5-35 mm <sup>2</sup>
Tightening torque of terminal screws		max. 4 Nm
Temperature range		
Ambient air		-25 to +40 °C, on 24h average ≤+35 °C
Storage		-25 to +60 °C
Temperature rise limits		
Terminals		≤+70 °K
Manual operating means		≤+25 °K
Parts intended to be touched		≤+40 °K
Parts need not to be touched		≤+50 °K
Flame class		V0, glowing wire test 960 °C
Pollution degree		3
Comparative tracking index		CTI 600
<b>Relay Component mechanical components</b>		
Upper and lower terminals		lift terminals
Terminal capacity		
solid		0.14-4 mm <sup>2</sup>
fine-wire		0.14-2.5 mm <sup>2</sup>
Tightening torque of terminal screws		0.5-0.7 Nm



## Dimensions (mm)

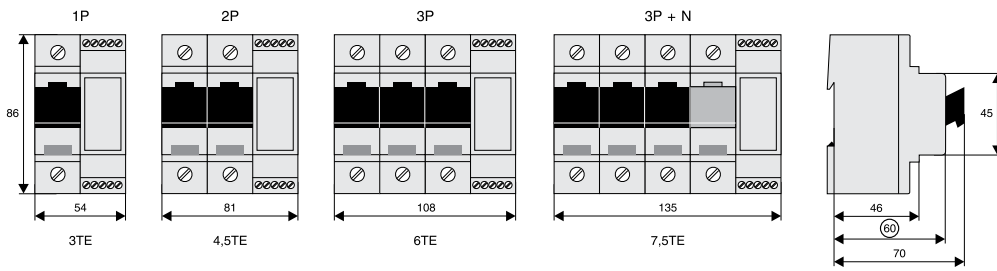

## Simplified diagram

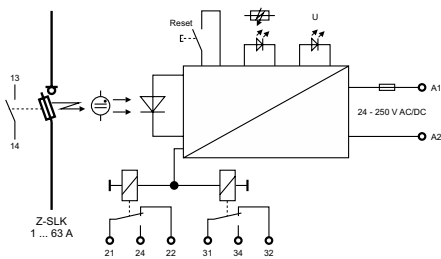

## Function - Switch position

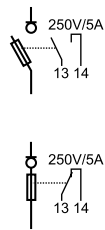

## Relay - Fuse monitoring

Uv . . . Supply voltage relay

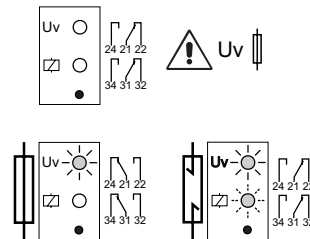



Rated current (A)	Type Designation	Article No.	Units per package
-------------------	------------------	-------------	-------------------

**Fuse-Link sets complete Z-SLS/B**

- For Z-SLS/NEOZ, Z-SLS/CEK, Z-SLK/NEOZ
- 1 set consists of 3 fuse-links, 3 gauge-pieces, 1 plastic box in the color of the visual tripping indicator - to snap on DIN rail

**With visual tripping indicator Z-SLS/B**

- Rated operational voltage 50-400 V AC / 50-250 V DC

SG81211



1	Z-SLS/B-1A	268983	1 / 12
2	Z-SLS/B-2A	268984	1 / 12
4	Z-SLS/B-4A	268985	1 / 12
6	Z-SLS/B-6A	268986	1 / 12
10	Z-SLS/B-10A	268987	1 / 12
13	Z-SLS/B-13A	289972	1 / 12
16	Z-SLS/B-16A	268988	1 / 12
20	Z-SLS/B-20A	268989	1 / 12
25	Z-SLS/B-25A	268990	1 / 12
32	Z-SLS/B-32A	289973	1 / 12
35	Z-SLS/B-35A	268991	1 / 12
40	Z-SLS/B-40A	289974	1 / 12
50	Z-SLS/B-50A	268992	1 / 12
63	Z-SLS/B-63A	268993	1 / 12

**With visual tripping indicator Z-SLS/B**

- Rated operational voltage 24-60 V AC / V DC

2	Z-SLS/B/24-2A	268995	1 / 12
4	Z-SLS/B/24-4A	268996	1 / 12
6	Z-SLS/B/24-6A	268997	1 / 12
10	Z-SLS/B/24-10A	268998	1 / 12
13	Z-SLS/B/24-13A	289975	1 / 12
16	Z-SLS/B/24-16A	268999	1 / 12
20	Z-SLS/B/24-20A	269000	1 / 12
25	Z-SLS/B/24-25A	269001	1 / 12
32	Z-SLS/B/24-32A	289976	1 / 12
35	Z-SLS/B/24-35A	269002	1 / 12
40	Z-SLS/B/24-40A	289977	1 / 12
50	Z-SLS/B/24-50A	269003	1 / 12
63	Z-SLS/B/24-63A	269004	1 / 12





#### Description Fuse-Link sets complete Z-SLS/B

- Fuse-Links with flashing function (Z-SLS/B) in case of disconnection
- Supplied as a set with 3 fuse-links and 3 gauge-pieces in plastic box of different colours which can be mounted onto DIN rail.
- Dimensions of plastic box:
  - Frame size 45 mm
  - Depth 75 mm
  - Width 54 mm

#### Connection diagram

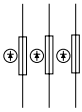

#### Technical Data

	Z-SLS/B
<b>Electrical</b>	
Operating class	gG (gL)
Rated voltage	
Z-SLS/B/24	24-60 V AC, 24-60 V DC
Z-SLS/B	50-400 V AC / 50-250V DC
Test voltage	5 kV
<b>Mechanical</b>	
Size	
D01	1, 2, 4, 6, 10, 13, 16 A
D02	20, 25, 32, 35, 40, 50, 63 A

#### Characteristics

Time/current characteristics of D0-Fuse-Links 2 ... 63A gG(gL)

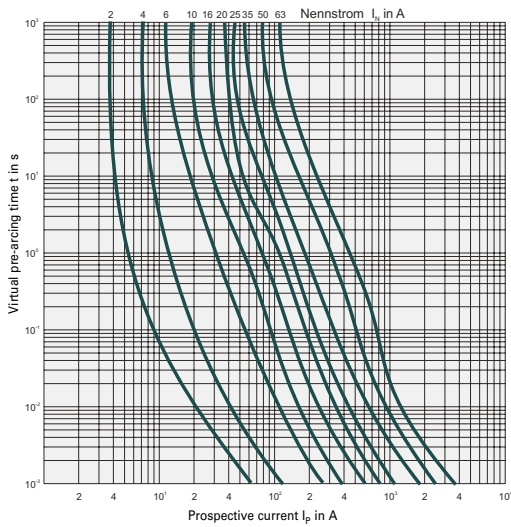

Let-through characteristics of D0-Fuse-Links 2 ... 63A gG(gL)

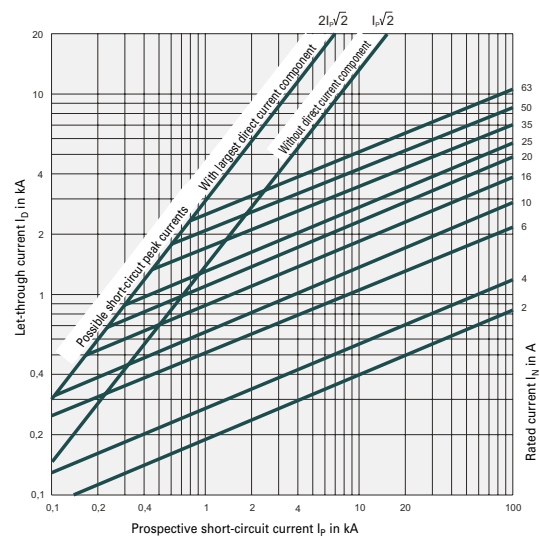



Rated current (A)	Type Designation	Article No.	Units per package
-------------------	------------------	-------------	-------------------

**Solid-link Set complete Z-SLS/TR-SET**

- For Z-SLS/NEOZ, Z-SLK/NEOZ, Z-SLS/CEK
- 1 set consists of 3 solid-link inserts, 3 gauge-pieces, 1 plastic box to be snapped onto DIN rail
- By installing this set, the fuse-switch-disconnector is converted into a switch-disconnector

SG81311



63	Z-SLS/TR-SET	100660	1 / 12
----	--------------	--------	--------

**Description Solid-link Set complete Z-SLS/TR-SET**

- Supplied as a set with 3 solid-links inserts and 3 gauge-pieces in plastic box which can be mounted onto DIN rail.
- Dimensions of plastic box:
  - Frame size 45 mm
  - Depth 75 mm
  - Width 54 mm

**Connection diagram**

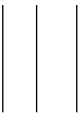

**Technical Data**

		Z-SLS/TR-SET
<b>Electrical</b>		
Rated voltage		400 V AC
Rated constant current	$I_u$	63 A
Test voltage		5 kV
<b>Mechanical</b>		
Size D02		63 A



Description	Type	Article No.	Units per package
<b>Switch-on-locking Z-SLZ/SP</b>			
<ul style="list-style-type: none"> <li>• For Z-SLS/NEOZ, Z-SLS/CEK, Z-SLK/NEOZ</li> <li>• Only one lock per device required</li> </ul>			
Plastic lock	Z-SLZ/SP	268981	1 / 12

SG81011





Poles	Rated constant current (A)	Type Designation	Article No.	Units per package
-------	----------------------------	------------------	-------------	-------------------

**Fuse-Switch-Disconnecter D02+D01**

**With visual tripping indicator Z-SLS/CB - Current coding by cartridge-ring adapter inserts**



1	max. 63	Z-SLS/CB/1	248247	12
1+N	max. 63	Z-SLS/CB/1+N	167282	6
2	max. 63	Z-SLS/CB/2	248248	6
3	max. 63	Z-SLS/CB/3	248249	4
3+N	max. 63	Z-SLS/CB/3+N	167283	3

**Accessories**

Fuse-Links Z-D0./SE-..

Cartridge-ring adapter inserts D01 Z-D02-D01/PE-..

Cartridge-ring adapter inserts D02 Z-D02/PE-..

Adapter Spring D01 Z-SLS/CB-HF see chapter Accessories Fuse Devices

**Description Fuse-Switch-Disconnecter with visual tripping indicator Z-SLS/CB - Current coding by cartridge-ring adapter inserts**

- Design according to IEC/EN 60947-3
- Current coding by means of cartridge-ring adapter inserts
- Visual tripping indicator is flashing
- Suitable for the following fuse-links  
D01: 2, 4, 6, 10, 13, 16 A with cartridge-ring adapter insert Z-D02-D01/PE-.. and Adapter Spring Z-SLS/CB-HF  
D02: 20, 25, 32, 35, 40, 50, 63 A
- Can be sealed with leads

**Connection diagram**

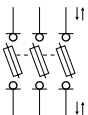

**Dimensions (mm)**

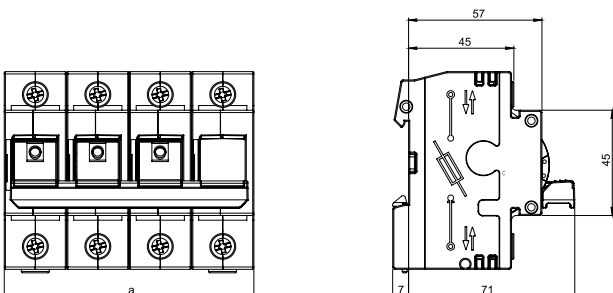

Poles	Dimension a [mm]
1P	27
1+N	54
2P	54
3P	81
3+N	108



#### Technical Data

		Z-SLS/CB
<b>Electrical</b>		
Number of poles		1P, 1+N, 2P, 3P, 3+N
Rated operational voltage	$U_e$	230 V AC 400 V AC
Rated operational current	$I_e$	63 A
Rated constant current	$I_u$	63 A
Conditional rated short circuit current		50 kA <sub>r.m.s.</sub>
Utilization category		AC 22B
Overvoltage category		IV
Rated peak withstand voltage	$U_{imp}$	6 kV
Power loss per current path $I_e$		0.5 W
Power loss per current path with fuse-link $I_e$		7.5 W
<b>Mechanical</b>		
Frame size		45 mm
Device height		86 mm
Device width		27 mm per pole (1.5MU)
Weight		
1P		120 g
1P+N		230 g
2P		230 g
3P		350 g
3P+N		448 g
Mounting		Quick fastening on DIN rail according to IEC/EN 60715
Degree of protection		IP20
Upper and lower terminals		lift terminals
Terminal capacity		1.5-35 mm <sup>2</sup>
Tightening torque of terminal screws		max. 4 Nm
Temperature range		-25 to +60 °C
Flame class		V0, glowing wire test 960 °C
Pollution degree		3
Comparative tracking index		CTI 600

#### Examples

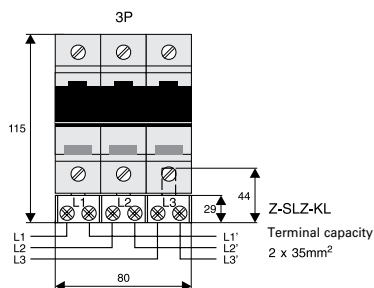
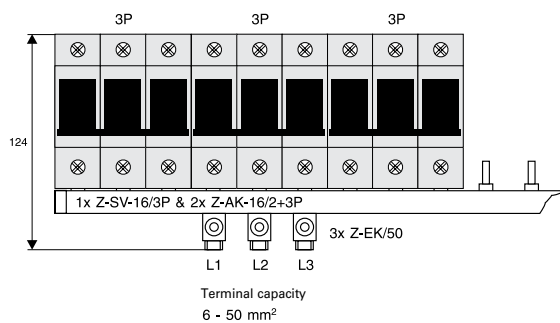
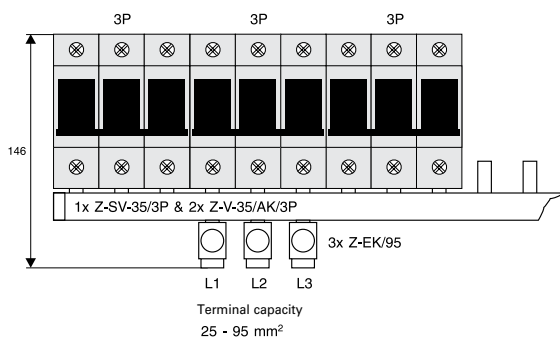



Size	Type Designation	Article No.	Units per package
------	------------------	-------------	-------------------

**Adapter Spring Z-SLS/CB-HF**

- For Z-SLS/CB/. for the use of fuse-links size D01

wa\_sg02712



D01	Z-SLS/CB-HF	263154	12 / 288
-----	-------------	--------	----------

Description	Type Designation	Article No.	Units per package
-------------	------------------	-------------	-------------------

**Double Terminal Z-SLZ/KL**

- For Z-SLS/NEOZ, Z-SLS/CEK, Z-SLK/NEOZ

SG60212



Terminal 2 x 3x35 mm <sup>2</sup>	Z-SLZ/KL	268982	15
-----------------------------------	----------	--------	----

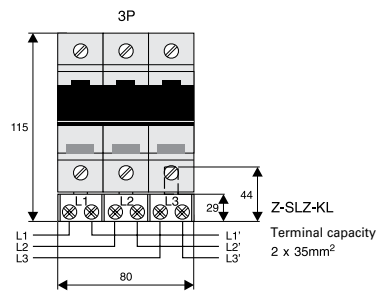

**Accessories for Z-SLS**

For busbar blocks and feed terminals refer to the technical part, fuse-switch-disconnector, and ordering part, busbar systems.



Poles	Rated constant current (A)	Type Designation	Article No.	Units per package
-------	----------------------------	------------------	-------------	-------------------

### Switch-Disconnecter-Fuse D02+D01

#### With visual tripping indicator D02-LTS

- Rated operational voltage 400 V AC
- Suitable for fuse-links with operating classes gG (gL), aM
- Only 4MU in width, busbar compatible to Xpole switchgear
- Current coding by cartridge-ring adapter inserts
- Can be sealed with leads
- Supply side from top or bottom
- Version with Auxiliary Switch D02-LTS/63-3-HK
- Delivered with Adapter Springs for fuse-links D01 or cylindrical fuse-links 10x38

SG80711



3	max. 63	D02-LTS/63-3	114320	3
3	max. 63	D02-LTS/63-3-HK	114322	3
3N	max. 63	D02-LTS/63-3N	114321	3

#### Accessories for D02-LTS

	Fuse-Links Z-D0/SE-... Cartridge-ring adapter inserts D01: Z-D02-D01/PE-... D02: Z-D02/PE-... Adapter Spring Z-D02-LTS-HF (scope of delivery)
	Fuse-Links Z-C10/SE-... Adapter Spring Z-D02-LTS-HF (scope of delivery)
Siehe Fuse Devices Accessories	

Max. Rated operational current I <sub>g</sub> (A)	Size	Type Designation	Article No.	Units per package
---	------	------------------	-------------	-------------------

#### Adapter Spring Z-D02-LTS-HF

- To accommodate D01 fuse-links or cylindrical fuse-links 10x38 in the Switch-disconnectorfuse D02-LTS/63...

SG81811



16	D02-D01	Z-D02-LTS-HF	114323	12 / 288
32	C 10x38			

### Description Switch-Disconnecter-Fuse D02-LTS - Current coding by cartridge-ring adapter inserts

- Design according to IEC/EN 60947-3
- Current coding by means of cartridge-ring adapter inserts
- Visual tripping indicator is flashing
- Suitable for fuse-links with operating classes gG (gL), aM
  - D01: 2, 4, 6, 10, 13, 16 A with cartridge-ring adapter insert Z-D02-D01/PE-... and Adapter Spring Z-D02-LTS-HF
  - D02: 20, 25, 32, 35, 50, 63 A
  - Cylindrical 10x38 up to 32 A with adapter spring Z-D02-LTS-HF
- Can be sealed with leads

#### Connection diagram

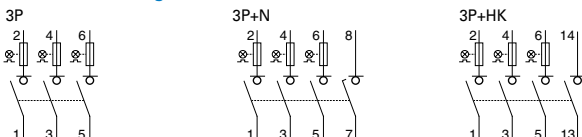



Technical Data

		D02-LTS
<b>Electrical</b>		
Number of poles		3P, 3P+N, 3P+HK
Rated operational voltage	$U_e$	400 V AC
Rated operational voltage range		48-400 V AC
Rated operational current	$I_e$	63 A
Rated constant current	$I_u$	63 A
Conditional rated short circuit current		50 kA <sub>r.m.s.</sub>
Utilization category		AC 22B
Overvoltage category		IV
Rated peak withstand voltage	$U_{imp}$	6 kV
Power loss per current path $I_e$		1.8 W
Power loss per current path with fuse-link $I_e$		7.3 W
Max. permissible power loss of fuse-links		5.5 W
Auxiliary Switch		
1P 1 NO		5 A / 250 V AC
Max. thermal back-up protection		2 A gL
<b>Mechanical</b>		
Frame size		45 mm
Device height		86 mm
Device width		18 mm per pole (1MU)
Weight		
3P		340 g
3P+N		380 g
3P+HK		380 g
Mounting		Quick fastening on DIN rail according to IEC/EN 60715
Degree of protection		IP20
Upper and lower terminals		lift terminals
Terminal capacity		1.5-2.5 mm <sup>2</sup>
Tightening torque of terminal screws		max. 3 Nm
Temperature range		-25 to +60 °C
Flame class		V0, glowing wire test 960 °C
Pollution degree		3
Comparative tracking index		CTI 600

Dimensions (mm)

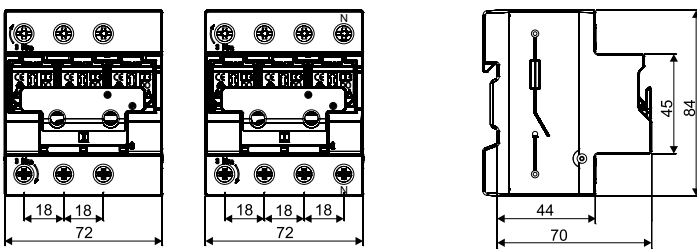

Example 3P, 3P+N

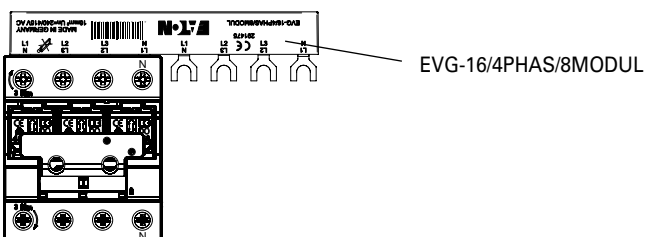



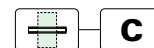

Poles	Size	Type Designation	Article No.	Units per package
-------	------	------------------	-------------	-------------------

### Fuse-Disconnecter (empty)

- For cylindrical fuse-links
- The visual tripping indicator indicates the tripped fuse-link
- Can be sealed with leads

#### For industry Z-SH

SG81211



##### Without visual tripping indicator

1	10x38	Z-SH/1	263876	12 / 120
1+N	10x38	Z-SH/1N	263877	12 / 120
2	10x38	Z-SH/2	263878	6 / 60
3	10x38	Z-SH/3	263879	4 / 40
3+N	10x38	Z-SH/3N	263880	4 / 40

SG38412



##### With visual tripping indicator

1	10x38	Z-SHL/1	263883	12 / 120
1+N	10x38	Z-SHL/1N	263884	12 / 120
2	10x38	Z-SHL/2	263885	6 / 60
3	10x38	Z-SHL/3	263886	4 / 40
3+N	10x38	Z-SHL/3N	263887	4 / 40

Rated current (A)	Size	Type Designation	Article No.	Units per package
-------------------	------	------------------	-------------	-------------------

#### For household applications Z-SI, 1pole

SG00412



##### Without visual tripping indicator

10	8.5x23	Z-SI/10/1	263889	12 / 120
16	10.3x25.8	Z-SI/16/1	263890	12 / 120
20	8.5x31.5	Z-SI/20/1	263891	12 / 120
25	10.3x31.5	Z-SI/25/1	263892	12 / 120
32	10.3x38	Z-SI/32/1	263893	12 / 120

##### With visual tripping indicator

20	8.5x31.5	Z-SIL/20/1	263901	12 / 120
25	10.3x31.5	Z-SIL/25/1	263902	12 / 120
32	10.3x38	Z-SIL/32/1	263903	12 / 120

#### For household applications Z-SI, 1+Npole

SG53912



##### Without visual tripping indicator

10	8.5x23	Z-SI/10/1N	263894	12 / 120
16	10.3x25.8	Z-SI/16/1N	263895	12 / 120
20	8.5x31.5	Z-SI/20/1N	263896	12 / 120
25	10.3x31.5	Z-SI/25/1N	263897	12 / 120
32	10.3x38	Z-SI/32/1N	263898	12 / 120

##### With visual tripping indicator

20	8.5x31.5	Z-SIL/20/1N	263938	12 / 120
25	10.3x31.5	Z-SIL/25/1N	263939	12 / 120
32	10.3x38	Z-SIL/32/1N	263940	12 / 120

### Accessories for Z-SH, Z-SI

Fuse-Links Z-C/SE...  
see chapter Accessories Fuse Devices



**Description Fuse-Disconnecter for Industrial Applications Z-SH**

- Design according to IEC/EN 60947-3
- Design
  - without visual tripping indicator Z-SH
  - with visual tripping indicator Z-SHL
- Can be sealed with leads
- Supplied without fuse-links

**Technical Data**

		Z-SH
<b>Electrical</b>		
Number of poles		1P, 1P+N, 2P, 3P, 3P+N
Rated voltage		
1P, 1P+N		230 V AC
2P, 3P, 3P+N		400 V AC
Rated operational current	$I_e$	32 A
Conditional short-circuit current		10 kA <sub>r.m.s.</sub>
Utilization category		AC 20B
Overvoltage category		IV
Rated peak withstand voltage	$U_{imp}$	4 kV
Fuse-Links		10, 16, 20, 25, 32 A
Operating class		gG(gL) / aM
Max. Power loss per current path		3.2 W
<b>Mechanical</b>		
Frame size		45 mm
Device height		80 mm
Device width		according to dimensioned drawing
Weight		Z-SH                      Z-SHL
1P		74 g                      76 g
1P+N		84 g                      86 g
2P		156 g                    158 g
3P		234 g                    236 g
3P+N		244 g                    246 g
Mounting		Quick fastening on DIN rail according to IEC/EN 60715
Degree of protection (built-in)		IP20 (IP40)
Upper and lower terminals		lift terminals
Terminal capacity		1.5-10 mm <sup>2</sup>
Tightening torque of terminal screws		max. 2 Nm
Temperature range		-25 to +60 °C
Dimensions of fuse-link		10.3 x 38 mm

**Connection diagram**

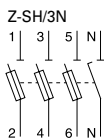

**Dimensions (mm)**

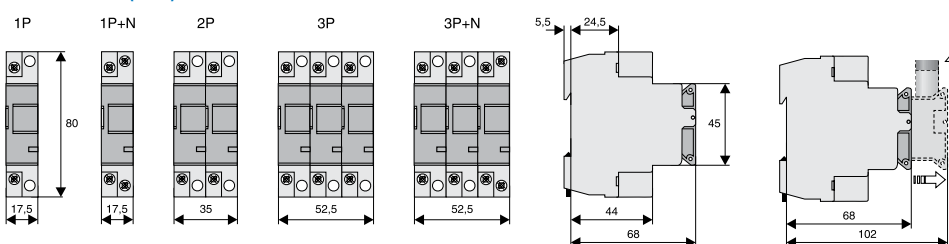





### Visual Tripping Indicator

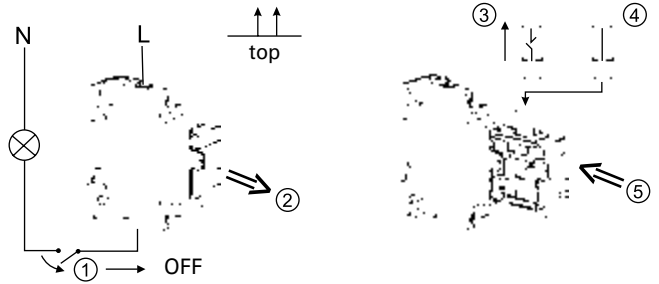

### Attention



 Do not switch the fuse-disconnector under load







## Visual Tripping Indicator

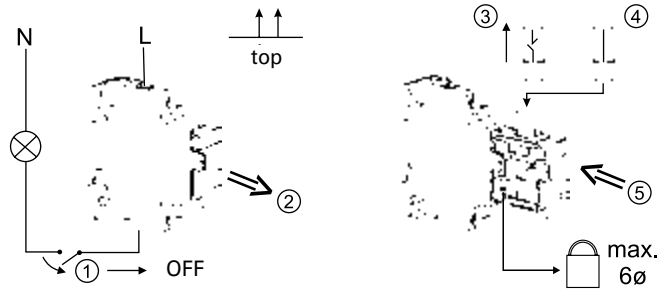

## Attention



 Do not switch the fuse-disconnector under load



Poles	Size	Type Designation	Article No.	Units per package
-------	------	------------------	-------------	-------------------

**Fuse-Switch-Disconnecter (empty) C10-SLS, VLCE**

- The visual tripping indicator indicates the tripped fuse-link
- Rated operational voltage 690 V AC
- For cylindrical fuse-links with operating classes gG (gL), aM
- Can be sealed with leads
- Supply side from top or bottom

**Size 10x38, Rated operational current 32 A, C10-SLS**

SG27212



**Without Visual Tripping Indicator**

1	10x38	C10-SLS/32/1	112220	12 / 108
1+N	10x38	C10-SLS/32/1N	112221	12 / 108
2	10x38	C10-SLS/32/2	112222	6 / 54
3	10x38	C10-SLS/32/3	112223	4 / 36
3+N	10x38	C10-SLS/32/3N	112224	4 / 36

**With Visual Tripping Indicator**

1	10x38	C10-SLS/32/1-L 1	112225	12 / 108
2	10x38	C10-SLS/32/2-L	112227	6 / 54
3	10x38	C10-SLS/32/3-L	112228	4 / 36

**Size 14x51, Rated operational current 50 A, VLCE14**

wa\_sg01917



**Without Visual Tripping Indicator**

1	14x51	VLCE14-1P	192373	12 / 96
1+N	14x51	VLCE14-1P+N	192375	6 / 48
2	14x51	VLCE14-2P	192376	6 / 48
3	14x51	VLCE14-3P	192377	4 / 32
3+N	14x51	VLCE14-3P+N	192379	3 / 24

**With Visual Tripping Indicator**

1	14x51	VLCE14-1P/L	192374	12 / 96
3	14x51	VLCE14-3P/L	192378	4 / 32

**Size 22x58, Rated operational current 100 A, VLCE22**

wa\_sg02017



**Without Visual Tripping Indicator**

1	22x58	VLCE22-1P	192380	3 / 105
1+N	22x58	VLCE22-1P+N	192381	2 / 48
2	22x58	VLCE22-2P	192382	2 / 48
3	22x58	VLCE22-3P	192370	1 / 35
3+N	22x58	VLCE22-3P+N	192372	1 / 24

**With Visual Tripping Indicator**

3	22x58	VLCE22-3P/L	192371	1 / 35
---	-------	-------------	--------	--------

**Accessories**

Fuse-Links	Z-C10/SE...
	Z-C14/SE..
	Z-C22/SE...

see chapter Accessories Fuse Devices



### Description Fuse-Switch-Disconnecter C10-SLS, VLCE

- Design according to IEC/EN 60947-3
- Design /L with visual tripping indicator (flashing)
- Suitable for cylindrical fuse-links with operating classes gG, aM
  - 10x38 C10-SLS
  - 14x51 VLCE14
  - 22x58 VLCE22
- Can be sealed with leads
- Supplied without fuse-links

### Technical Data

	C10-SLS	VLCE14	VLCE22
<b>Electrical</b>			
Number of poles	1P, 1P+N, 2P, 3P, 3P+N	1P, 1P+N, 2P, 3P, 3P+N	1P, 1P+N, 2P, 3P, 3P+N
Rated operational voltage	$U_e$		
1P	690 V, 50 Hz	690 V, 50 Hz	690 V, 50 Hz
1P+N	400 V, 50 Hz	690 V, 50 Hz	690 V, 50 Hz
2P, 3P, 3P+N	690 V, 50 Hz	690 V, 50 Hz	690 V, 50 Hz
Rated operational current	$I_e$		
32 A	32 A	50 A	100 A
Conditional rated short circuit current	100 kA (at 400 V)	120 kA	120 kA
Rated short-time withstand current	$I_{cw}$		
300 A	300 A	600 A	1200 A
Utilization category	$U_i$		
AC 22B	AC 22B	AC 22B	AC 21B
Rated insulation voltage	690 V	690 V	690 V
Overvoltage category	II	III	III
Rated impulse withstand voltage	$U_{imp}$		
4 kV	4 kV	8 kV	8 kV
Power loss per current path without fuse-link	0.9 W	1 W	3.1 W
Maximum permissible power loss of fuse-links			
gG	3 W	5 W	9.5 W
aM	1.2 W	3 W	7 W
<b>Mechanical</b>			
Frame size	45 mm	45 mm	45 mm
Device height	83.3 mm	94 mm	121 mm
Device width	17.5 mm / pole	W = 27 mm / pole	W = 36 mm / pole
Weight			
1P	58 g	100 g	156 g
1P+N	70 g	222 g	351 g
2P	120 g	206 g	317 g
3P	180 g	310 g	476 g
3P+N	195 g	434 g	671 g
Mounting	Quick fastening on DIN rail according to IEC/EN 60715		
Degree of protection	IP20	IP20	IP20
Upper and lower terminals	lift terminals	lift terminals	lift terminals
Terminal capacity	0.5 - 10 mm <sup>2</sup>	1.5 - 35 mm <sup>2</sup>	4 - 50 mm <sup>2</sup>
	AWG 20-8	AWG 18-6	AWG 12-2
Tightening torque of terminal screws	≤ 1.2 Nm	2.5 - 3 Nm	2.5 - 3 Nm
Ambient temperature range	-25 to +40 °C	-25 to +40 °C	-25 to +40 °C
Flame class	glow wire 960 °C	glow wire 960 °C	glow wire 960 °C
Pollution degree	2	3	3
Comparative tracking index	CTI 450	CTI 450	CTI 450

### Connection diagram

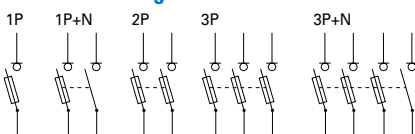



Dimensions (mm)

C10-SLS

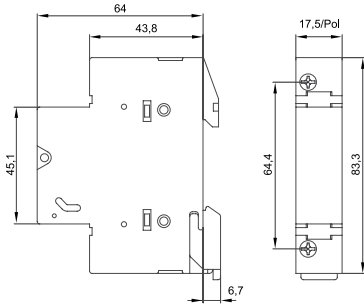

VLCE14

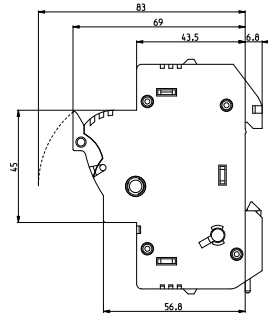

VLCE22

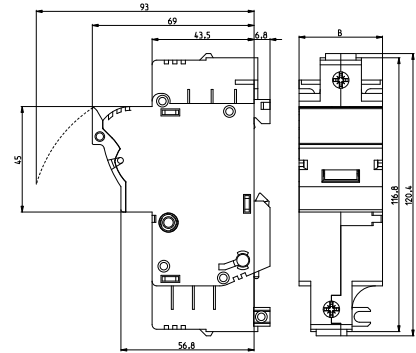



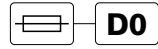

Size	Rated current (A)	Type Designation	Article No.	Units per package
------	-------------------	------------------	-------------	-------------------

### Fuse-Links Z-D0./SE, Operating class gG (gL)

- In practical plastic box in the color of the visual tripping indicator - to snap on DIN rail



D01	2	Z-D01/SE-2	288934	12/288
D01	4	Z-D01/SE-4	288935	12/288
D01	6	Z-D01/SE-6	288936	12/288
D01	10	Z-D01/SE-10	288937	12/288
D01	13	Z-D01/SE-13	288938	12/288
D01	16	Z-D01/SE-16	288939	12/288



D02	20	Z-D02/SE-20	288940	12/144
D02	25	Z-D02/SE-25	288941	12/144
D02	32	Z-D02/SE-32	288942	12/144
D02	35	Z-D02/SE-35	288943	12/144
D02	40	Z-D02/SE-40	288944	12/144
D02	50	Z-D02/SE-50	288945	12/144

### Description Fuse-Links Z-D0./SE, Operating class gG (gL)

- According to DIN VDE 0636, DIN 49522
- For Fuse-Switch-Disconnecter Z-SLS, -SLK
- For Fuse-Bases D0.-SO and Z-D02/R/3

### Technical Data

Z-D0./SE	
<b>Electrical</b>	
Operating class	gG (gL)
Rated voltage	
AC	400 V
DC	250 V
Rated frequency	45-65 Hz
Rated insulation voltage	$U_i$ 2500 V
Rated short-circuit breaking capacity	
AC	50 kA
DC	8 kA
<b>Mechanical</b>	
Size	
D01	1, 2, 4, 6, 10, 13, 16 A
D02	20, 25, 32, 35, 40, 50, 63 A

### Characteristics Z-D0./SE

Time/current characteristics of Z-D0-Fuse-Links 2 ... 63A gG(gL)

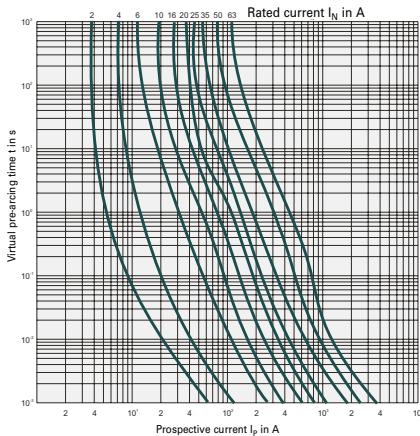

Let-through characteristics of Z-D0-Fuse-Links 2 ... 63A gG(gL)

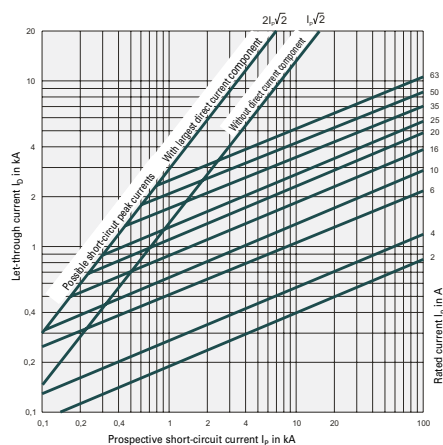

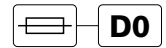

Size	Rated current (A)	Type Designation	Article No.	Units per package
------	-------------------	------------------	-------------	-------------------

**Cartridge-Ring Adapter Insert**

**Cartridge-Ring Adapter Insert Z-D0./PE**

- In practical plastic box in the color of the visual tripping indicator - to snap on DIN rail

SG81611



D01	2	Z-D01/PE-2	288909	12/288
D01	4	Z-D01/PE-4	288910	12/288
D01	6	Z-D01/PE-6	288911	12/288
D01	10, 13	Z-D01/PE-10	288912	12/288
D02	20	Z-D02/PE-20	288913	12/288
D02	25	Z-D02/PE-25	288914	12/288
D02	35, 32	Z-D02/PE-35	288915	12/288
D02	40	Z-D02/PE-40	288916	12/288
D02	50	Z-D02/PE-50	288917	12/288

**Cartridge-Ring Adapter Insert Z-D02-D01/PE**

- D01 for Fuse-Base D02 and Fuse-Switch-Disconnecter D02
- In practical plastic box in the color of the visual tripping indicator - to snap on DIN rail

SG81511



D02-D01	2	Z-D02-D01/PE-2	263112	12/288
D02-D01	4	Z-D02-D01/PE-4	263113	12/288
D02-D01	6	Z-D02-D01/PE-6	263150	12/288
D02-D01	10, 13	Z-D02-D01/PE-10	263151	12/288
D02-D01	16	Z-D02-D01/PE-16	263152	12/288

**Description Cartridge-Ring Adapter Insert Z-D0./PE, Z-D02-D01/PE**

- According to DIN 49523
- Used for current coding of D0.-SO, Z-D02/R/3, Z-SLS/CB

**Technical Data**

Electrical		Z-D0./PE, Z-D02-D01/PE
Rated current		
D01		2 - 10 A
D02		20 - 50 A
D02-D01		2 - 16 A

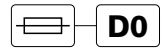

Size	Rated current (A)	Type Designation	Article No.	Units per package
------	-------------------	------------------	-------------	-------------------

### Screw Caps Z-D0./SK

wa\_sg04013



D01	max. 16	Z-D01/SK	100650	20
D02	max. 63	Z-D02/SK	100651	20

### Description Screw Caps Z-D0./SK

- Used for D0.-S0, Z-D02/R/3
- Adapter Spring Z-D02/SIKA-HF for application of D01 fuse-links into the screw cap Z-D02/SK available

### Technical Data

#### Z-D0./SK

#### Electrical

Rated current

D01	max. 16 A
D02	max. 63 A

#### Mechanical

Electrical thread

D01	E14
D02	E18

### Practical Hint

A complete and functioning D-fuse system consists of base + fuse-link + cartridge-ring adapter insert + screw cap.

The cartridge-ring adapter insert is not required for the highest rated current of each size (D01...16A and D02...63A).

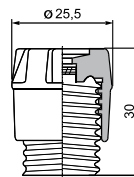

Size	Type Designation	Article No.	Units per package
------	------------------	-------------	-------------------

### Adapter Spring Z-D02/SIKA-HF

- To apply D01-Fuse-Links into the screw cap Z-D02/SK

wa\_sg02612



D02-D01	Z-D02/SIKA-HF	263149	50/3000
---------	---------------	--------	---------

### Cartridge-ring adapter insert plier Z-D0-PE-Z

SG19707



D01, D02	Z-D0-PE-Z	114324	1 / 10
----------	-----------	--------	--------

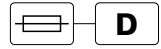

Size	Rated current (A)	Type Designation	Article No.	Units per package
<b>Screw-in Gauge Ring Z-DII./PS</b>				
DII E27	2	Z-DII/PS-2A	112138	25/1500
DII E27	4	Z-DII/PS-4A	112139	25/1500
DII E27	6	Z-DII/PS-6A	112140	25/1500
DII E27	10	Z-DII/PS-10A	112141	25/1500
DII E27	16	Z-DII/PS-16A	112142	25/1500
DII E27	20	Z-DII/PS-20A	112143	25/1500
DII E27	25	Z-DII/PS-25A	112144	25/1500
DIII E33	35	Z-DIII/PS-35A	112145	25/850
DIII E33	50	Z-DIII/PS-50A	112146	25/850
DIII E33	63	Z-DIII/PS-63A	112147	25/850

wa\_sg03312



**Description Screw-in Gauge Ring Z-DII./PS**

- Used for current coding of DII.-SO/...-PS

**Technical Data**

**Z-DII./PS**

**Electrical**

Rated current

DII	2 - 25 A
DIII	35 - 63 A

**Dimensions (mm)**

I <sub>n</sub> (A)	A	B	C	D
<b>DII for Fuse-Base E27</b>				
2	3/16"	6.5	17	24
4	3/16"	6.5	17	24
6	3/16"	6.5	17	24
10	3/16"	8.5	17	24
16	3/16"	10.5	17	24
20	3/16"	12.5	17	24
25	3/16"	14.5	17	24
<b>DIII for Fuse-Base E33</b>				
35	3/16"	16.5	17	24
50	3/16"	18.5	17	24
63	3/16"	20.5	17	24

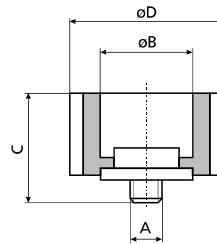

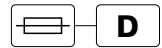

Size	Rated voltage (V AC)	Type Designation	Article No.	Units per package
<b>Screw Caps CD, Z-DII./SK</b>				
DIII E33	690	Z-DIII/SK-690	118904	3

SG07608



### Description Screw Caps CD, Z-DII./SK

- Used for DII.-SO

### Technical Data

		Z-DII./SK
<b>Electrical</b>		
Rated current		
DII		max. 25 A
DIII		max. 63 A
Rated voltage		
CD27		500 V AC / 400 V DC
CD33		500 V AC / 400 V DC
Z-DIII/SK-690		690 V AC
<b>Mechanical</b>		
Electrical thread		
DII		E27
DIII		E33

### Dimensions (mm)

$I_n$ (A)	A	B	C	D
CD27	E27	44	12	34
CD33	E33	44	12	43
Z-DIII/SK-690	43	65	12	43

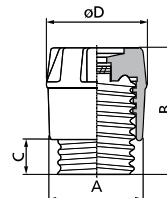

### Practical Hint

A complete and functioning D-fuse system consists of

- base for screw-in gauge ring + fuse-link + screw-in gauge ring + screw cap
- base for gauge ring + fuse-link + gauge ring + screw cap

The gauge ring is not required for the highest rated current of each size (DII ... 25 A and DIII ... 63 A).

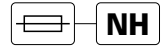

Size	Type Designation	Article No.	Units per package
------	---------------------	-------------	----------------------

**Solid-Links Z-NH-../TR**

wa\_sg04413

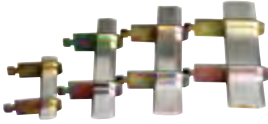

Size	Type Designation	Article No.	Units per package
00	Z-NH-00/TR	263114	3 / 180
1	Z-NH-1/TR	263115	6 / 60
2	Z-NH-2/TR	263116	6 / 60
3	Z-NH-3/TR	263117	3 / 30



Size	Rated current (A)	Type Designation	Article No.	Units per package
------	-------------------	------------------	-------------	-------------------

**NH-Fuse-Links, 500 V AC, Z-NH**

- Operating class gG (gL)

1	63	Z-NH-1/63	290011	3
1	80	Z-NH-1/80	290012	3
2	250	Z-NH-2/250	290022	3

wa\_sg03412



**Description NH-Fuse-Links, 500 V AC, Z-NH**

- Design according to ÖVE-SN 40, IEC 60269, VDE 0636, SEV 1066
- Dimensions according to Austrian standard ÖNORM E-6020, DIN 43.620
- NH-fuse-links of operating class gG/gL are used for line protection. They reliably disconnect overcurrent and short-circuit current above the permitted levels up to the nominal breaking current.
- gG/gL NH-fuse-links also protect electrical systems and equipment against the electrodynamic effects of high short-circuit currents.
- Insulating bodies of steatite/corderite
- Full contact blade of silver-plated copper
- Double blow-out indicator (flat indicator and centre indicator), live grips
- Corrosion-proof
- NH-fuse-links have a selectivity of 1:1.6 (ratio of the series-connected nominal currents), permitting optimum utilization and protection of line cross-sections.
- Strict current limitation permits reduced mechanical dimensions of electrical systems
- High breaking capacity of 120 kA

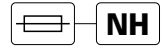

**Technical Data**

	Z-NH-1/	Z-NH-2/
<b>Electrical</b>		
Rated voltage		
AC	500 V	500 V
DC	440 V	440 V
Nominal current	50-250 A	100-400 A
Rated frequency	45-62 Hz	45-62 Hz
Nominal breaking capacity		
AC	120 kA	120 kA
DC	25 kA	25 kA
Nominal breaking capacity		
$I_n = 10 A$	-	-
16 A	-	-
20 A	-	-
25 A	-	-
35 A	-	-
40 A	-	-
50 A	5.4 W	-
63 A	6.3 W	-
80 A	7.2 W	-
100 A	8.6 W	8.8 W
125 A	11.9 W	12.1 W
160 A	13.9 W	14.0 W
200 A	15.2 W	15.2 W
250 A	21.8 W	21.8 W
315 A	-	23.7 W
400 A	-	30.5 W
500 A	-	-
630 A	-	-

**Dimensions (mm)**

Type	Size	A	B	C	D	E	F	G	H	K	
Z-NH-00/	up to 100 A	000	79	53	47	35	15	21	52	7.5	6
	125 - 160 A	00	79	53	47	35	15	28	56	12	6
Z-NH-1/	up to 160 A	1C	135	68	65	40	15	28	61	12	6
	200 - 250 A	1	135	72	65	40	20	46	65	14	6
Z-NH-2/	up to 250 A	2C	150	72	65	48	20	46	73	14	6
	315 - 400 A	2	150	72	65	48	26	54	73	14	6
Z-NH-3/	up to 400 A	3C	150	72	65	60	26	54	84	14	6
	500 - 630 A	3	150	72	65	60	33	65	84	14	6

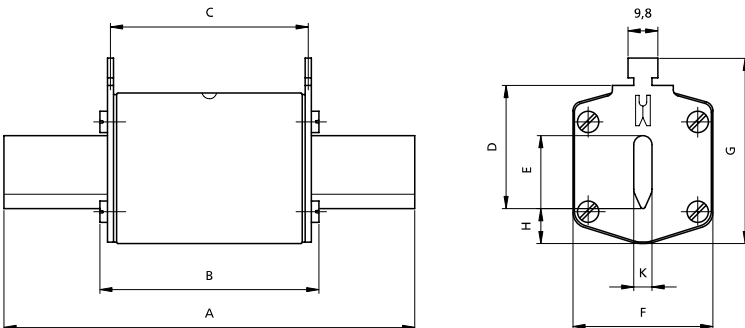



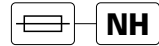

### Let-through Current Characteristic, Current Limitation Diagram

The characteristic shows the limited let-through current values (peak values) depending on the prospective short-circuit current (r. m. s.) under unfavourable connection conditions and depending on the respective nominal current.

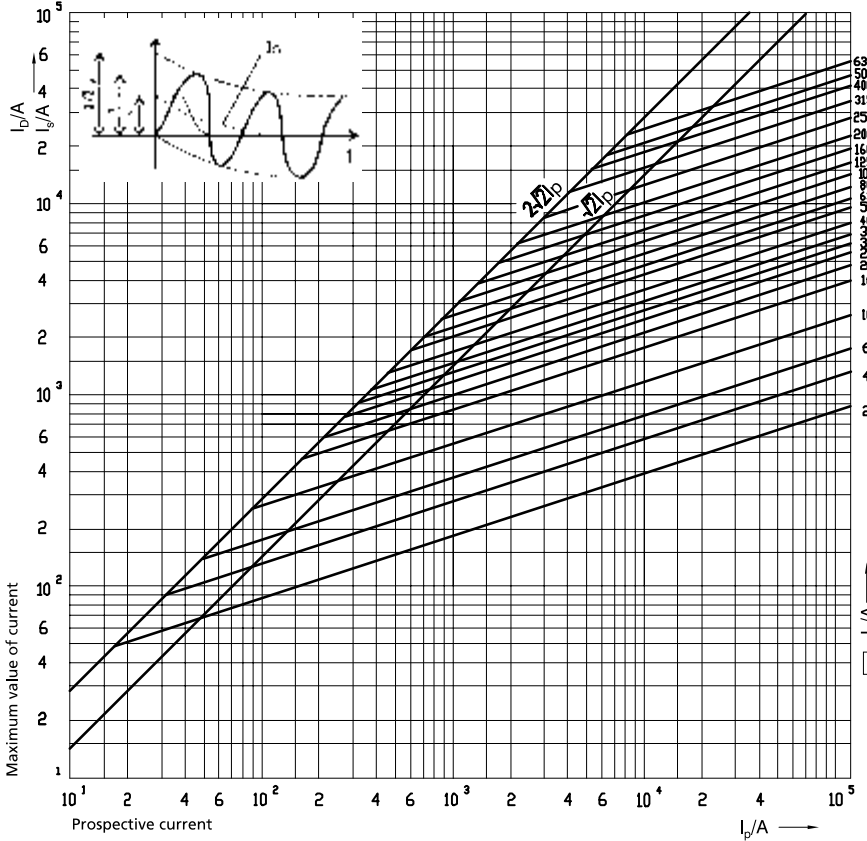

### Correction Factor for DC Component

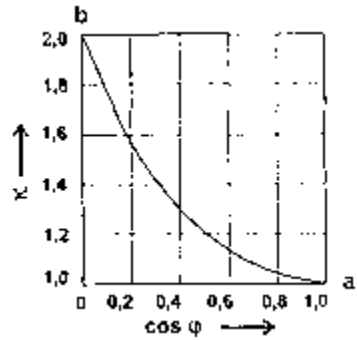

a Surge short-circuit current without DC component ( $\kappa = 1$ )  
 b Surge short-circuit current with maximum DC component ( $\kappa = 2$ )

$I_D$  let-through current  
 $I_G$  declining DC component  
 $I_p$  prospective short-circuit current  
 $I_s$  surge short-circuit current =  $I_p \cdot \kappa \cdot \sqrt{2}$   
 $\kappa$   $\kappa=2$  for  $\cos \phi=0$ ,  $\kappa=1$  for  $\cos \phi=1$

### Time-Current Characteristics

For NH-fuse-links 2 - 630 A operating class gL/gG

The time-current characteristics are valid at an ambient temperature of 20±5°C and for the cable (line) cross-sections assigned in the regulations for test arrangements.

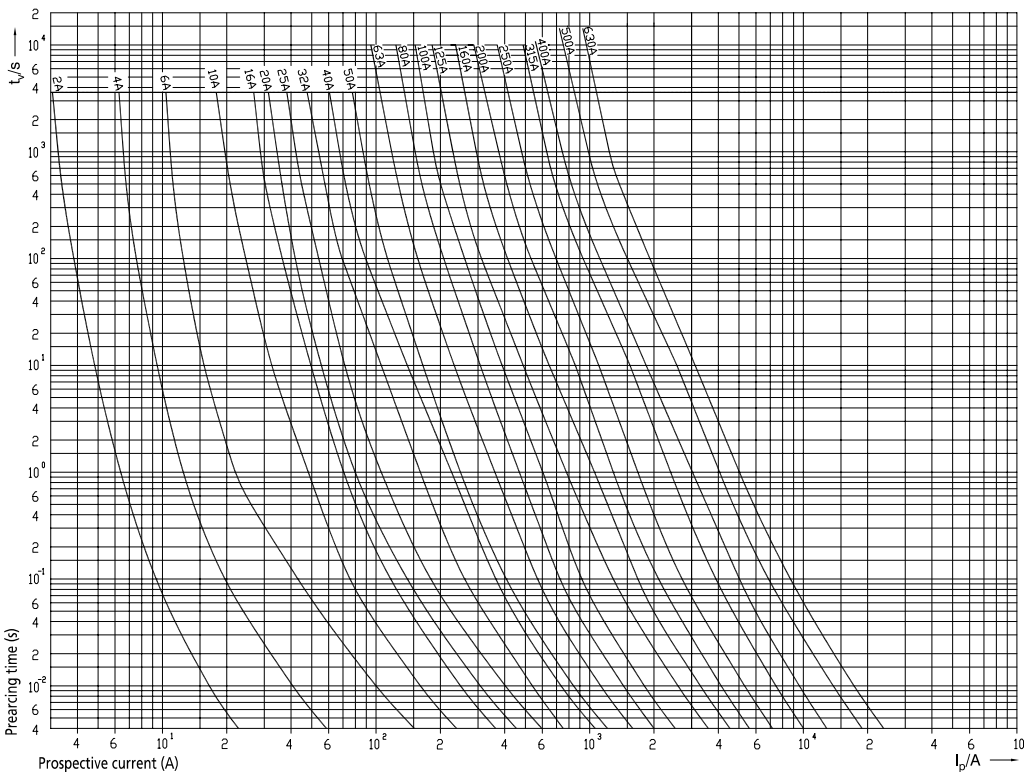

sg68912

138103900



1	1	16	16
2	2	17	17
3	3	18	18
4	4	19	19
5	5	20	20
6	6	21	21
7	7	22	22
8	8	23	23
9	9	24	24
10	10	25	25
11	11	26	26
12	12	27	27
13	13	28	28
14	14	29	29
15	15	30	30

Stromkreisverzeichnis beschriften und auf die Innenseite der Tür kleben  
Zugehörige Nummernschilder auf Geräte kleben

sg68912



Design	Type Designation	Article No.	Units per package
--------	------------------	-------------	-------------------

### Protective Earth Socket Z-SD230

Standard	Z-SD230	266875	10 / 50
Earth pin with integrated increased protection against accidental contact	Z-SD230-BS	266876	10 / 50

### Accessories Busbar Block

Busbar	Z-SV-10/1P+N-SD	269526	10
End caps	Z-V-AK/2+3P	264930	10 / 600

### Description Protective Earth Socket Z-SD230

- Design according to VDE, ÖVE, IEC 60884-1, DIN 49440-1
- Modular busbar connection system L/N
- Screw fastening is possible
- Width 2.5MU
- Busbar block Z7-SD/1P+N 10 mm<sup>2</sup> available
- Model -BS with integrated increased protection against accidental contact and earth pin

### Technical Data

Z-SD230	
<b>Electrical</b>	
Standards	IEC 60884-1, DIN 49440-1
Rated voltage	250 V AC
Rated current	10/16 A
<b>Mechanical</b>	
Frame size	45 mm
Device height	76 mm
Device width	44 mm
Mounting	quick fastening on DIN rail IEC/EN 60715, screw-mounting possible
Degree of protection, built-in	IP40, IP20 without front cove
Upper and lower terminals	lift terminals
Terminal capacity	1 to 2x2.5 mm <sup>2</sup>
Ambient operational temperature	-5° C .....+40° C; max. Ø 35° C @ 24 h
Recommended torque for Terminals L, N, PE	0.8 Nm

### Connection diagram



### Dimensions (mm)

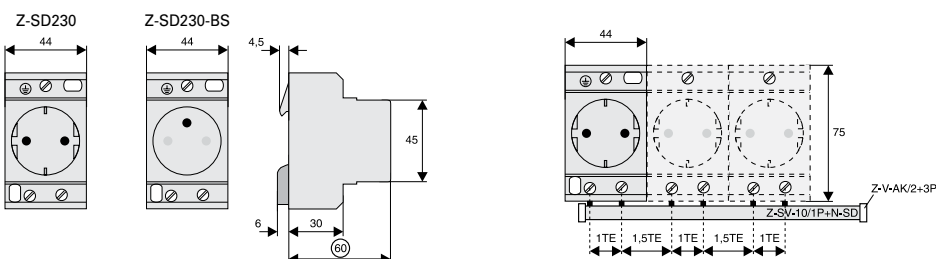

Neutral Conductor Lead-Through Terminal, Feed Terminal Z-D

Rated current / Design	Type Designation	Article No.	Units per package
------------------------	------------------	-------------	-------------------

**Neutral Conductor Lead-Through Terminal, Feed Terminal Z-D**

SG59511



63 A	Z-D63	248267	12/120
63 A with test socket	Z-D63/P	248268	12/120
100 A	Z-D80	248269	12/120

**Description Neutral Conductor Lead-Through Terminal, Feed Terminal Z-D**

- Compatible with standard busbar to Xtra Combination devices
- Z-D80: Feeder block for busbar system 80 A.  
Lift terminal (35 mm<sup>2</sup>) and open mouthed terminal above, lift terminal (50 mm<sup>2</sup>) below.  
Busbar positioning optionally above or below
- Z-D80: with testing bush 4 mm Ø, 10 A for N-conductor

**Technical Data**

	Z-D63	Z-D63/P	Z-D80
<b>Electrical</b>			
Rated current	63 A	63 A	100 A
Frequency	50-60 Hz	50-60 Hz	50-60 Hz
N-conductor test bush	–	10 A, Ø 4 mm	–
<b>Mechanical</b>			
Frame size	45 mm	45 mm	45 mm
Device height	80 mm	80 mm	80 mm
Device width	17.5 mm (1MU)	17.5 mm (1MU)	17.5 mm (1MU)
Mounting	quick fastening with 2 lock-in positions on DIN rail IEC/EN 60715		
Degree of protection, built-in	IP40	IP40	IP40
Terminals			
above	open mouthed/lift terminals	open mouthed/lift terminals	open mouthed/lift terminals
below	open mouthed/lift terminals	open mouthed/lift terminals	lift terminals
Terminal capacity			
above	1-25 mm <sup>2</sup>	1-25 mm <sup>2</sup>	1-35 mm <sup>2</sup>
below	1-25 mm <sup>2</sup>	1-25 mm <sup>2</sup>	2.5-50 mm <sup>2</sup>
Busbar thickness	0.8 - 2 mm	0.8 - 2 mm	0.8 - 2 mm

**Connection diagram**

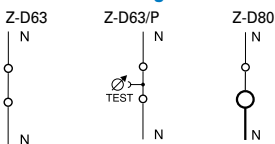

**Dimensions (mm)**

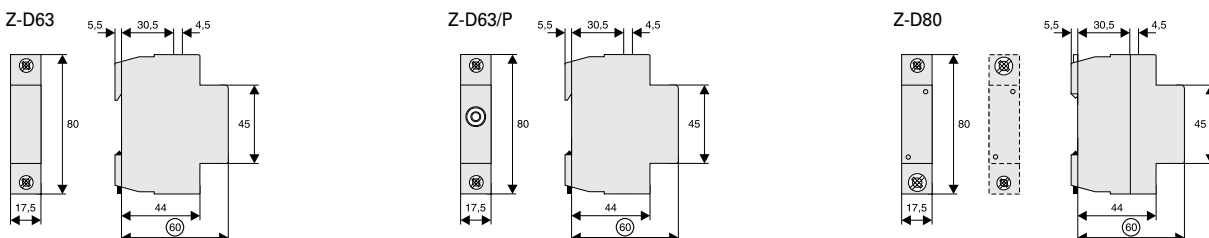

Type Designation Article No. Units per package

### Front Plate Tripping Device Z-MFPA

SG58911



Z-MFPA 248302 6 / 60

### Description Front Plate Tripping Device Z-MFPA

- Mechanical tripping device for PXF, P XK, FAZ, PLSM, Z-A40, PKNM and PKDM, responds when the front plate of a distribution box is removed
- Maximum tripping capacity: 4 + 4 poles symmetrically
- Can be interlocked by twisting when the tripping pin is in the pressed position

### Technical Data

	Z-MFPA
<b>Mechanical</b>	
Frame size	45 mm
Device height	80 mm
Device width	17.5 mm
Mounting	quick fastening on DIN rail IEC/EN 60715
Degree of protection, built-in	IP40

### Function Diagram



### Dimensions (mm)

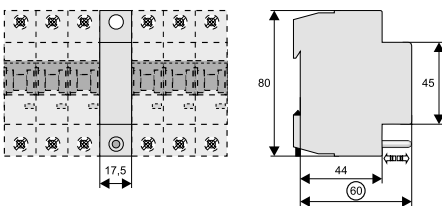

### Function

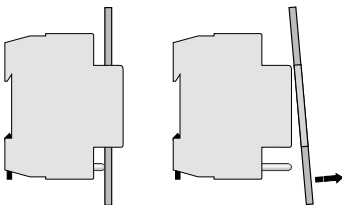

Circuit Description GR, Plastic Box Z-BOX, Neutral Disconnecter

Number of Circuits	Dimensions (mm)	Type Designation	Article No.	Units per package
--------------------	-----------------	------------------	-------------	-------------------

**Circuit Description GR**

- Self-adhesive table for synoptic description of circuits, to be attached inside or on a distribution box.
- Pre-printed individual adhesive labels for device designation included

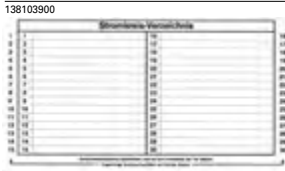

30	210x120	GR-2	138103900	1
90	210x300	GR-3	138104100	1

Colour	Dimensions (mm)	Type Designation	Article No.	Units per package
--------	-----------------	------------------	-------------	-------------------

**Plastic Box Z-BOX**

- Empty, can be snapped onto DIN rail
- For spare fuse links, small spare parts



blue	45x54x75	Z-BOX/BLA	286062	12/120
------	----------	-----------	--------	--------

Description	Type Designation	Article No.	Units per package
-------------	------------------	-------------	-------------------

**Neutral disconnecter**



Neutral disconnecter	Z-NTS	248443	1
----------------------	-------	--------	---

Eaton's electrical business is a global leader with deep regional application expertise in power distribution and circuit protection; power quality, backup power and energy storage; control and automation; life safety and security; structural solutions; and harsh and hazardous environment solutions. Through end-to-end services, channel and an integrated digital platform & insights Eaton is powering what matters across industries and around the world, helping customers solve their most critical electrical power management challenges.

For more information, visit [Eaton.com](https://www.eaton.com).



<http://id1.hu/eaton>

**Eaton Industries (Austria) GmbH**  
Scheydgasse 42  
1210 Vienna  
Austria

**Eaton**  
EMEA Headquarters  
Route de la Longeraie 7  
1110 Morges, Switzerland

© 2022 Eaton  
All Rights Reserved  
Publication No. CA019015EN  
Article number 302576-MK  
June 2022

Changes to the products, to the information contained in this document, and to prices are reserved; as are errors and omissions. Only order confirmations and technical documentation by Eaton is binding. Photos and pictures also do not warrant a specific layout or functionality. Their use in whatever form is subject to prior approval by Eaton. The same applies to trademarks (especially Eaton, Moeller, and Cutler-Hammer). The Terms and Conditions of Eaton apply, as referenced on Eaton Internet pages and Eaton order confirmations.

Eaton is a registered trademark.

All other trademarks are property of their respective owners.

Follow us on social media to get the latest product and support information.

