



Sedna

Catalogue 2020



Life Is On

Schneider
Electric



Content

- Introduction 4
- Mechanisms without cover frame..... 18
 - Switches and Push-buttons 18
 - Dimmers 24
 - Thermostats 25
 - USB chargers 25
 - Socket-outlets..... 26
 - Data and Telephone outlets 27
 - Antenna outlets 29
 - Other functions..... 31
- Mechanisms with cover frame 32
- Boxes 33
- Cover frames..... 34
- Technical information..... 36
 - Switches and Push-buttons connection diagrams 36
 - Rotary dimmers 37
 - Thermostat 43
 - USB chargers 46
 - Key card switches..... 47
 - Data and Telephone outlets 48
 - Antenna outlets 51
 - Surface mounting Boxes..... 54
 - Cover frames..... 55
- Reference number overview 56

Introduction

Sedna is pure design

Offer to your customers an original alternative to traditional white switches and sockets. With its streamlined design and elegant colors, the Sedna range will give you the edge you are looking for.



Flat design,
8 mm depth

Colors

With 8 colored frames and 6 colored inserts available, you can offer a rich and diverse product range with a minimum of stock management required.

8 colored frames



6 colored inserts

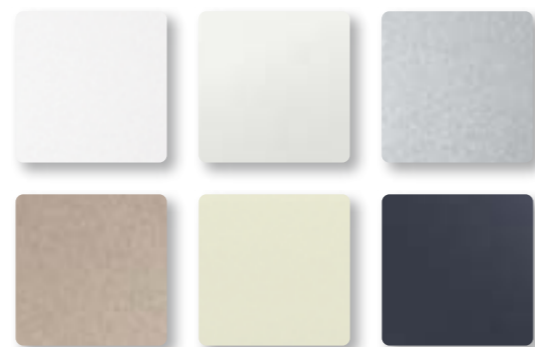

Functions

Sedna offers full functionality of a flexible switch program. Whether switches or sockets, dimmers, thermostats or movement detectors, the Sedna range leaves nothing to be desired and meets all requirements on a modern electrical installation.



1-way switch



1-way switch with pilot lamp



2-circuit switch with pilot lamp



Push-button with pilot lamp



USB charger



Socket outlet with shutters



Socket outlet with shutters



Roller blind control switch



Movement detector



Rotary dimmer



Room thermostat



Rotary push-button dimmer



Tel + data outlet



TV/R/SAT outlet



Movement detector



Socket-outlet with lid, IP44



RJ45



More comfort for your customers...

Combining comfort, lighting and heating control, Sedna has it all. The Advanced functions can help to simplify your customers' lives and demonstrate the added value of your business.

Comfort at the fingertips

The home beats to the rhythm of the occupants' personal routine and needs:

- heating systems programmed to offer optimum comfort from the moment residents step through the door;
- light dimmers provide just the right level of brightness;
- roller blinds can be controlled with one flick of a switch.

A safe environment

Sometimes, all it takes is one detail to make the home safer. All Sedna socket outlets come with shutters to prevent accidents. Motion detectors can also provide automatic lighting so that occupants can move around safely and easily during the night.

All the connections they need

Offer your customers a powerful network to connect to the internet or watch television anywhere in the home.



Light control

Advanced light control functions increase comfort and safety: At night, the illuminated switch will guide you in corridors or entrances.

Dimmer

Dim your lights to a pleasant light level.

Movement detector

Automatically switch on and off depending on presence detection and the light condition (light sensor).

Roller blinds control

For protection from sun, cold and unwanted attention or burglary – controlled with one flick of a switch.

Temperature control

With a room thermostat the temperature permanently stays comfortable, but also helps to control energy costs.

Connectivity

Internet, PC, TV, telephones, network technology and multimedia functions for a modern life:

- RJ45
- TV/R/SAT

IP44

Socket-outlets and switches with IP44 frames are perfect for use in damp rooms like cellars, garages, workshops, production facilities and outdoors.

Socket-outlets

Socket outlets with shutters protect your customer from touching the metal parts under tension.





The new generation of inserts that are so easy to install

Do you install switches and socket-outlets on a regular basis? Then we've got good news for you! We've come up with a new generation of socket-outlets and switch inserts that make installation simple, fast and convenient.

Designed to meet your needs

At Schneider Electric, we listen to your feedback and we understand what you need to make your day-to-day work run more smoothly. This is why we've recently improved the quality and functionality of inserts for the Sedna range. The updated Sedna range now features reliable screwless socket-outlets, high quality claws, secure robustness as well as additional, smart functions that provide an efficient installation workflow for each step: for connecting, aligning, fastening, fixing and testing! Installation has never been so easy, fast and convenient.

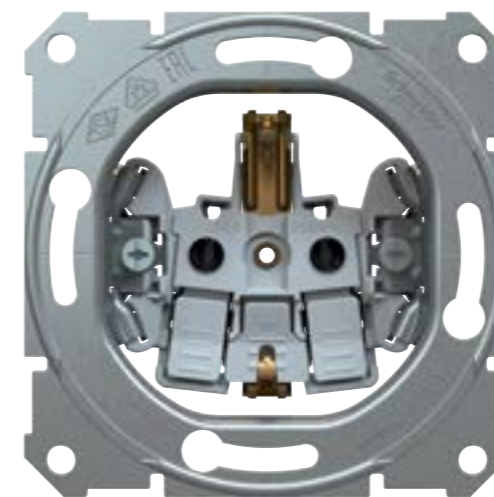

New socket-outlet with screwless terminal

We understand that electricians appreciate the simple, fast and convenient installation of flush-mounted inserts. That's why we've come up with screwless socket-outlet terminals - which make wiring easy, quick and reliable.

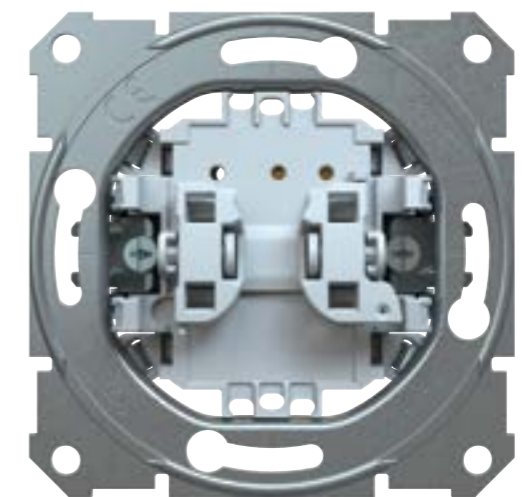

New switch and push-button insert with improved features!

Newly designed switch and push-button inserts let you connect more easily, align and fasten more quickly, test more conveniently, and effortlessly add additional functions.

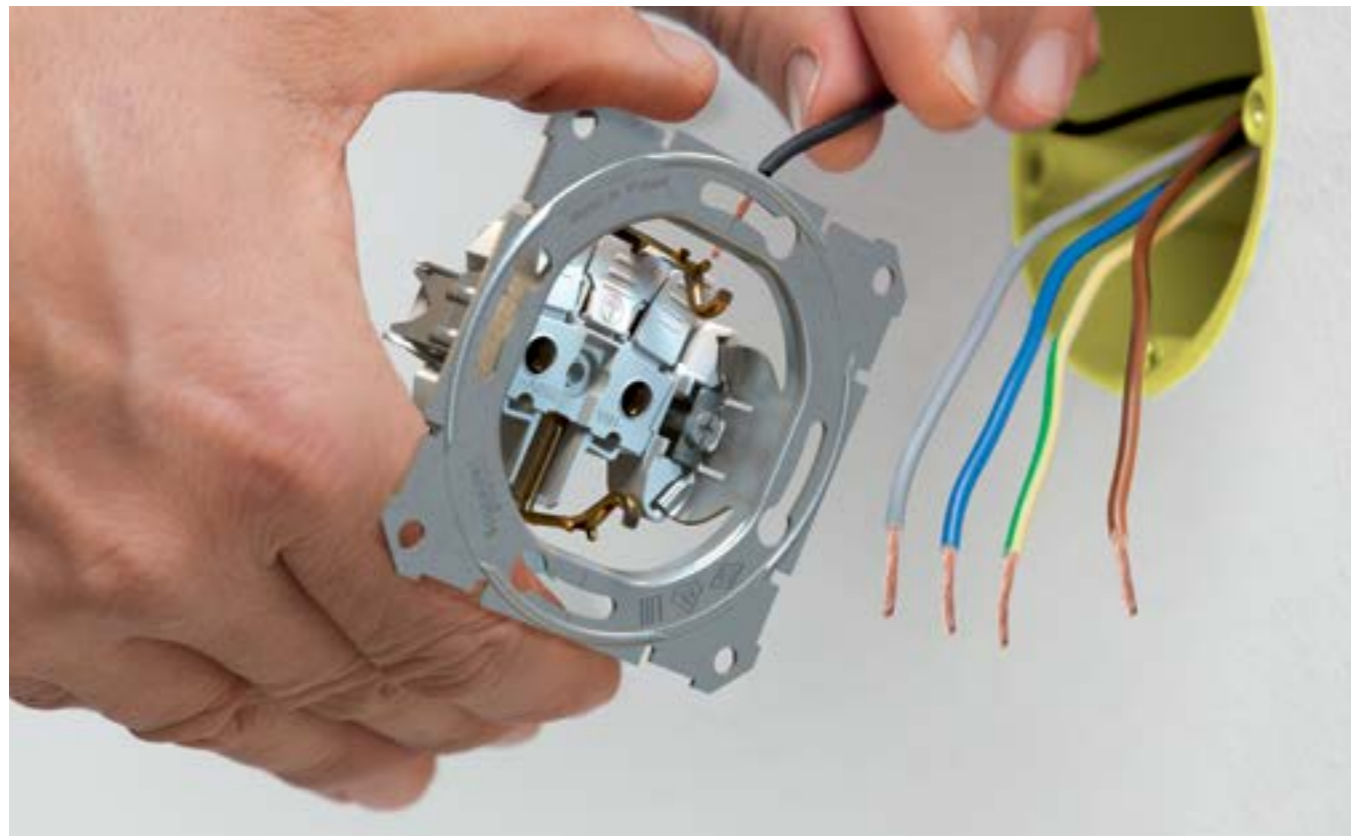

Socket-outlet with screwless terminal

The new Sedna socket-outlet features a screwless terminal – which has been redesigned, to ensure a simple, fast and reliable installation.

NEW!

- + Time saving
- + Reliable
- + Screwless

Easy-to-use release buttons

Release buttons are easy to access. Large in size, the release buttons reduce surface pressure on your finger. Improved mechanics now make the release of the fastened wires even smoother.

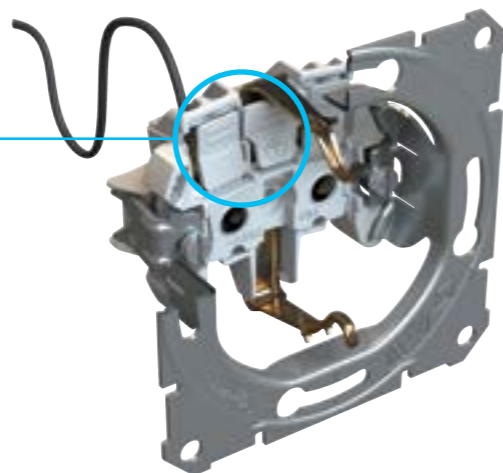

Switch and push-button inserts

It only takes the slightest glance to notice that numerous features have been optimized to make your installation workflow more efficient.

Release buttons

New button mechanics make the release of fastened wires easier and smoother than ever.

Conical cable entries

Conical cable entries make it easier to feed the connection wires into the terminal blocks. The terminal shapes are guiding wires into the right place.

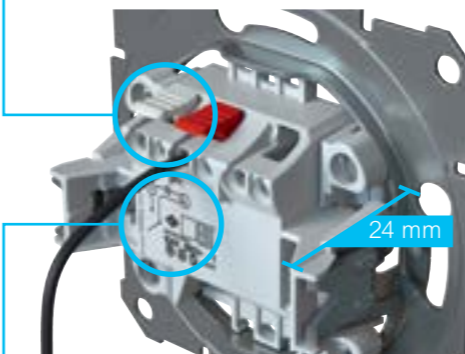

Low mounting depth

A low mounting depth of 24 mm provides more freedom of movement for the insert during the wiring process.

Wiring diagram

The wiring diagram is printed on the rear of the switch and push-button base. Here, the switch type and connection options are clearly visible.



Convenient front-side testing

Checkpoints allow convenient testing of all functions and measuring from the front – and there's no need to disassemble the switch.

Lighting modules

Whether as a first installation or as a renovation, you can now add LED lighting modules and rockers to Sedna push-button and switch inserts, without having to remove the inserts.

- LED module indication light, red
- LED module orientation light, blue
- LED light modul for hotel key card switch, blue



Improved!

- + new features
- + easy-to-operate functions
- = faster installation!

For a simple and fast installation

When it comes to aligning and fastening, our innovative new features will make all the difference to your daily installation projects.

Innovative new functions that offer a smooth installation workflow

The new Sedna inserts feature robust fixing frames as well as clear alignment markings, which make switch and socket-outlet insert installation quick and easy – even on uneven walls. Cleverly designed new claws also contribute to an installation procedure that is extremely simple and fast.

Screw slots

The screw slots allow rotation of the insert in either direction, to correct installation boxes that have been misaligned. These slots are a perfect fit for flush mounted box standard screws, so fixing is now even easier and even more reliable.

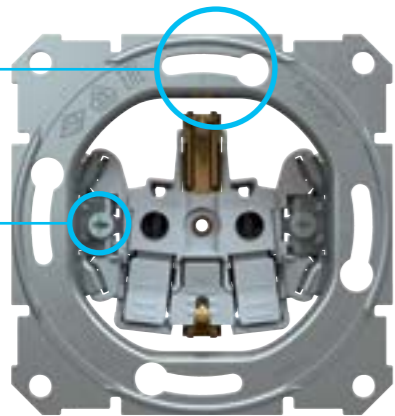

Claw-return function

The claw-return function makes mounting and realignment easier than ever.

Protected claws

Pre-installation, the claws are fully retracted in the sides of the housing. This means that the claws cannot catch during the installation process, which minimizes the risk of injury. If not required, then the claws remain retracted, which makes for an even easier installation.

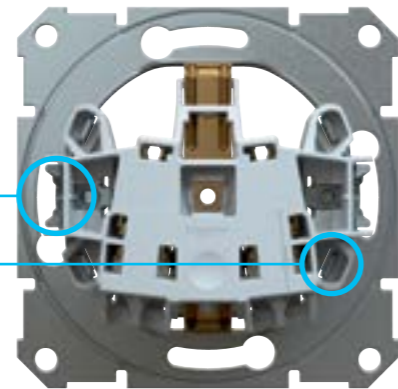

4 point fixation

Insert and fixing frame are very robust thanks to the strong and reliable 4 point fixation.

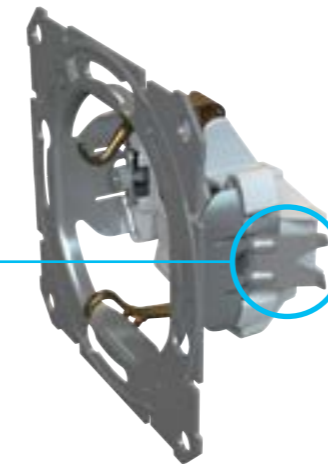

Claws for perfect alignment

Thanks to its redesigned mechanism, the claws extend out straight and smoothly, ensuring a perfect alignment to the wall boxes during assembly. The claws ensure that the insert fixes stable in the box.

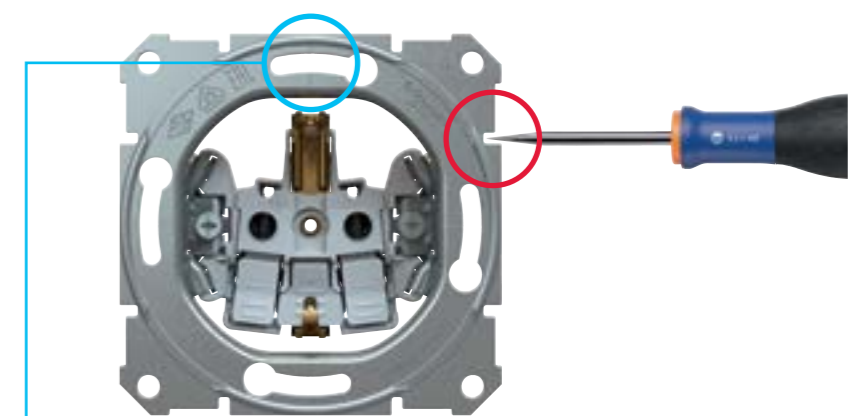

Alignment markings and slots

Clear alignment markings and screwdriver slots make it easy to adjust inserts and give a clear orientation, to ensure perfect alignment of multiple inserts.



New frames for all conditions

The new Sedna switches and push-buttons provide a new mechanism, that allows easy assembly of frames, inserts and rockers in installation process.

Optimized for your convenience!

With the new "one easy click" mechanism, the frame and the insert can be connected very simply. The optimized interface of both parts allow a simple plug-in and the frame already fits perfectly on the insert. Completely new and practical: No adapter is required to mount the rocker.

No adapter necessary



The new "one easy click" interlocking mechanism

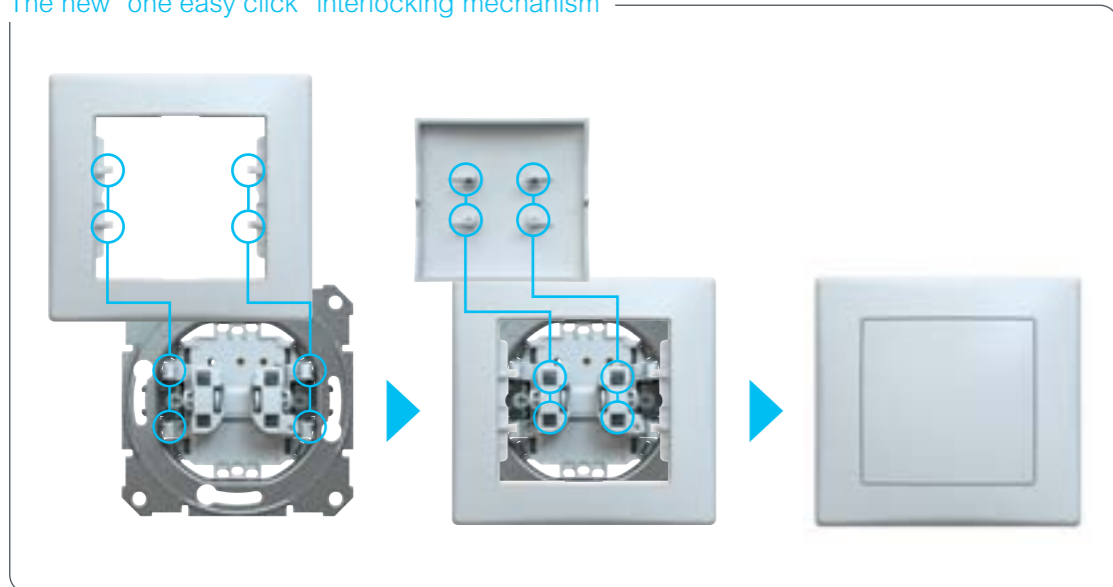

Compatibility means flexibility

Backwards and forwards compatibility gives you the ultimate in installation flexibility, to satisfy your customers' short- and long-term needs.

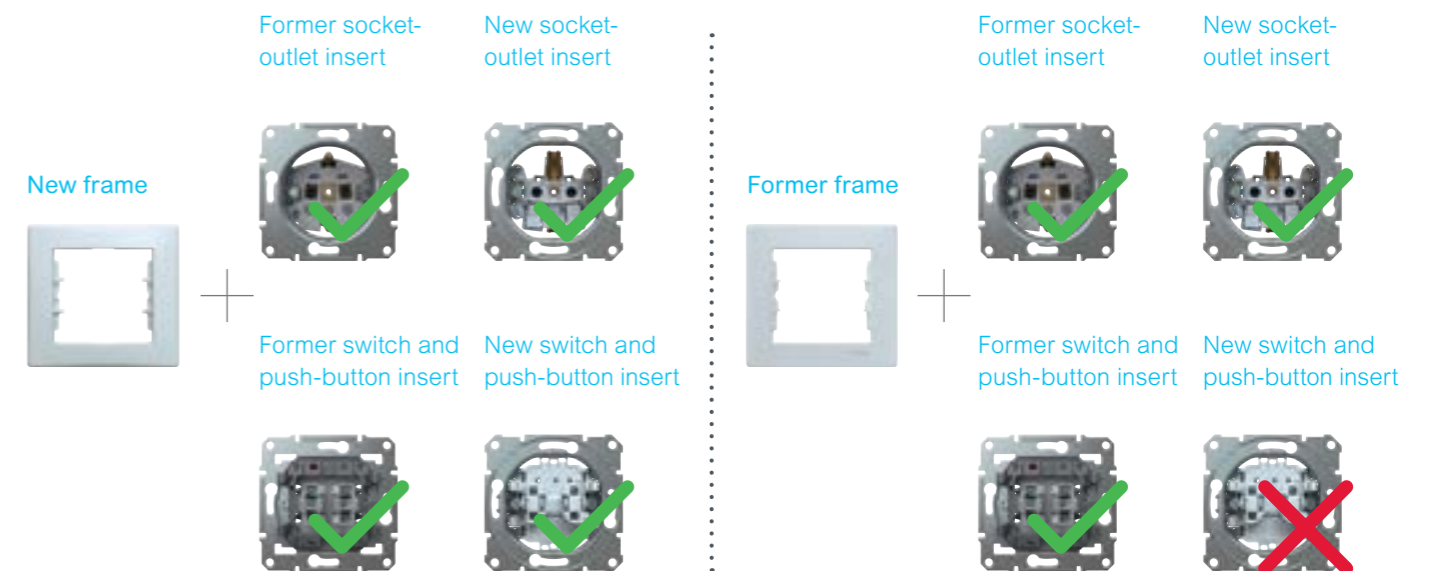

New IP44 frames

In wet areas or conditions, switches and socket-outlets must conform to strict regulatory standards – which state that they must be weatherproof and must also protect against the threat of moisture. The new Sedna IP44 frames are available in 1-3 gang, horizontal, and come in a complete range of colors. Thanks to the featured membrane seals, these frames meet the IP44 standard for Sedna switches, push-buttons and socket-outlets.

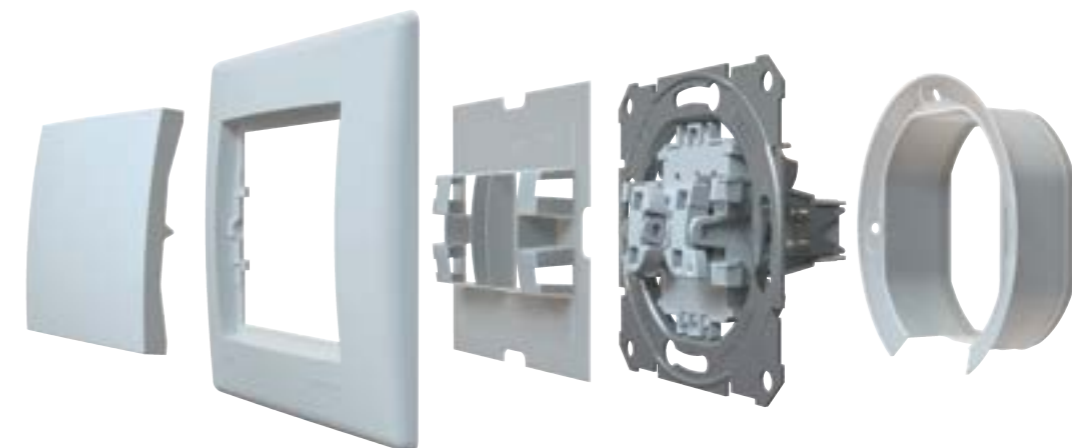

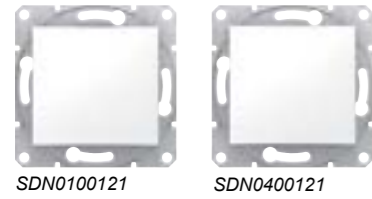

Switches

10 AX - 250 V AC switches

Colour	1-way screwless	2-way screwless
white	SDN0100121	SDN0400121
cream	SDN0100123	SDN0400123
aluminium	SDN0100160	SDN0400160
titanium	SDN0100168	SDN0400168
beige	SDN0100147	SDN0400147
graphite	SDN0100170	SDN0400170
Intermediate screwless		
white	SDN0500121	
cream	SDN0500123	
aluminium	SDN0500160	
titanium	SDN0500168	
beige	SDN0500147	
graphite	SDN0500170	
Double 2-way screwless		
white	SDN0600121	
cream	SDN0600123	
aluminium	SDN0600160	
titanium	SDN0600168	
beige	SDN0600147	
graphite	SDN0600170	
2-circuit screwless		
white	SDN0300121	
cream	SDN0300123	
aluminium	SDN0300160	
titanium	SDN0300168	
beige	SDN0300147	
graphite	SDN0300170	
3-circuit screwless		
white	SDN0300621	
cream	SDN0300623	
aluminium	SDN0300660	
beige	SDN0300647	
graphite	SDN0300670	
2-pole screwless		
white	SDN0200121	
cream	SDN0200123	
aluminium	SDN0200160	
titanium	SDN0200168	
beige	SDN0200147	
graphite	SDN0200170	

Characteristics

- Maximum load for self ballasted lamps (LED, CFL, etc.):
10 AX - 250 V AC switches: 100 W
16 AX - 250 V AC switches: 200 W



16 AX - 250 V AC switches

Colour	2-way screwless
white	SDN0400421
cream	SDN0400423
aluminium	SDN0400460
titanium	SDN0400468
beige	SDN0400447
graphite	SDN0400470
2-pole screwless	
white	SDN0200221
cream	SDN0200223
aluminium	SDN0200260
titanium	SDN0200268
beige	SDN0200247
graphite	SDN0200270

IP44 10 AX - 250 V AC switches

Colour	1-way screwless	2-way screwless
white	SDN0100321	SDN0400521
cream	SDN0100323	SDN0400523
aluminium	SDN0100360	SDN0400560
titanium	SDN0100368	SDN0400568
beige	SDN0100347	SDN0400547
graphite	SDN0100370	SDN0400570
Intermediate screwless		
white	SDN0500321	
cream	SDN0500323	
aluminium	SDN0500360	
titanium	SDN0500368	
beige	SDN0500347	
graphite	SDN0500370	
2-circuit screwless		
white	SDN0300421	
cream	SDN0300423	
aluminium	SDN0300460	
titanium	SDN0300468	
beige	SDN0300447	
graphite	SDN0300470	
2-pole screwless		
white	SDN0200321	
cream	SDN0200323	
aluminium	SDN0200360	
titanium	SDN0200368	
beige	SDN0200347	
graphite	SDN0200370	

Characteristics

- Maximum load for self ballasted lamps (LED, CFL, etc.):
10 AX - 250 V AC switches: 100 W
16 AX - 250 V AC switches: 200 W

Switches (cont'd)

10 AX - 250 V AC switches with blue locator lamp

1-way screwless		2-way screwless	
Colour		Colour	
<input type="checkbox"/> white	SDN1400121	<input type="checkbox"/> white	SDN1500121
<input type="checkbox"/> cream	SDN1400123	<input type="checkbox"/> cream	SDN1500123
<input type="checkbox"/> aluminium	SDN1400160	<input type="checkbox"/> aluminium	SDN1500160
<input type="checkbox"/> titanium	SDN1400168	<input type="checkbox"/> titanium	SDN1500168
<input type="checkbox"/> beige	SDN1400147	<input type="checkbox"/> beige	SDN1500147
<input type="checkbox"/> graphite	SDN1400170	<input type="checkbox"/> graphite	SDN1500170

Intermediate screwless	
Colour	
<input type="checkbox"/> white	SDN0501121
<input type="checkbox"/> cream	SDN0501123
<input type="checkbox"/> aluminium	SDN0501160
<input type="checkbox"/> titanium	SDN0501168
<input type="checkbox"/> beige	SDN0501147
<input type="checkbox"/> graphite	SDN0501170

2-circuit screwless	
Colour	
<input type="checkbox"/> white	SDN0300321
<input type="checkbox"/> cream	SDN0300323
<input type="checkbox"/> aluminium	SDN0300360
<input type="checkbox"/> titanium	SDN0300368
<input type="checkbox"/> beige	SDN0300347
<input type="checkbox"/> graphite	SDN0300370

10 AX - 250 V AC switches with red indicator lamp

1-way screwless		2-way screwless	
Colour		Colour	
<input type="checkbox"/> white	SDN0400321	<input type="checkbox"/> white	SDN0401121
<input type="checkbox"/> cream	SDN0400323		
<input type="checkbox"/> aluminium	SDN0400360		
<input type="checkbox"/> titanium	SDN0400368		
<input type="checkbox"/> beige	SDN0400347	<input type="checkbox"/> beige	SDN0401147
<input type="checkbox"/> graphite	SDN0400370	<input type="checkbox"/> graphite	

2-pole screwless	
Colour	
<input type="checkbox"/> white	SDN0201121
<input type="checkbox"/> cream	SDN0201123
<input type="checkbox"/> aluminium	SDN0201160
<input type="checkbox"/> titanium	SDN0201168
<input type="checkbox"/> beige	SDN0201147
<input type="checkbox"/> graphite	SDN0201170

Characteristics

- Maximum load for self ballasted lamps (LED, CFL, etc.):
10 AX - 250 V AC switches: 100 W
16 AX - 250 V AC switches: 200 W

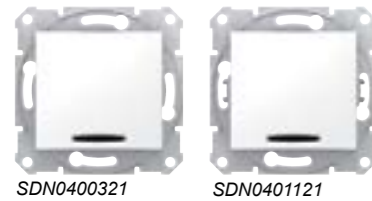
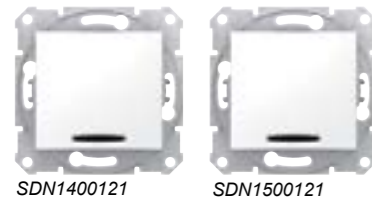

16 AX - 250 V AC switches with blue locator lamp

2-way screwless	
Colour	
<input type="checkbox"/> white	SDN1500221
<input type="checkbox"/> cream	SDN1500223
<input type="checkbox"/> aluminium	SDN1500260
<input type="checkbox"/> titanium	SDN1500268
<input type="checkbox"/> beige	SDN1500247
<input type="checkbox"/> graphite	SDN1500270

16 AX - 250 V AC switches with red indicator lamp

2-pole screwless	
Colour	
<input type="checkbox"/> white	SDN0201221
<input type="checkbox"/> beige	SDN0201247

10 AX - 250 V AC key card switch

Mechanical, screwless	
Colour	
<input type="checkbox"/> white	SDN1900121
<input type="checkbox"/> cream	SDN1900123
<input type="checkbox"/> aluminium	SDN1900160
<input type="checkbox"/> titanium	SDN1900168
<input type="checkbox"/> beige	SDN1900147
<input type="checkbox"/> graphite	SDN1900170

Roller blinds and shutters controls

10 AX - 250 V AC switch	10 A - 250 V AC push-button
With electric lock, screwless	With electric lock, screwless
Colour	Colour
<input type="checkbox"/> white	SDN1300321
<input type="checkbox"/> cream	SDN1300323
<input type="checkbox"/> aluminium	SDN1300360
<input type="checkbox"/> titanium	SDN1300368
<input type="checkbox"/> beige	SDN1300347
<input type="checkbox"/> graphite	SDN1300370
	<input type="checkbox"/> white
	SDN1300121
	<input type="checkbox"/> cream
	SDN1300123
	<input type="checkbox"/> aluminium
	SDN1300160
	<input type="checkbox"/> titanium
	SDN1300168
	<input type="checkbox"/> beige
	SDN1300147
	<input type="checkbox"/> graphite
	SDN1300170

Cord push-buttons

10 A - 250 V AC	
Screwless with cord	
Colour	
<input type="checkbox"/> white	SDN1200121
<input type="checkbox"/> cream	SDN1200123
	Cord length: 200 cm ±5 cm

Characteristics

- Maximum load for self ballasted lamps (LED, CFL, etc.):
10 AX - 250 V AC switches: 100 W
16 AX - 250 V AC switches: 200 W

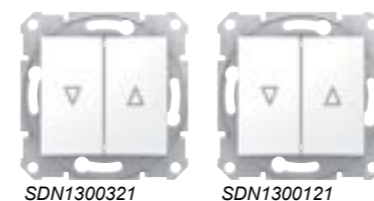

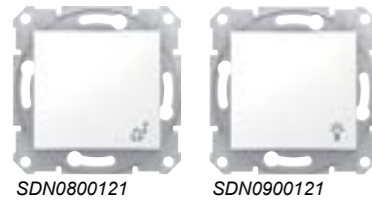
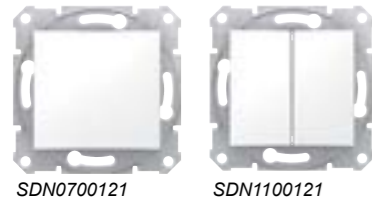

Push-buttons

10 A - 250 V AC push-buttons

Colour	1-way, screwless	Double-1-way, screwless
white	SDN0700121	SDN1100121
cream	SDN0700123	SDN1100123
aluminium	SDN0700160	SDN1100160
titanium	SDN0700168	SDN1100168
beige	SDN0700147	
graphite	SDN0700170	SDN1100170
Colour	1-way, with bell symbol, screwless	1-way, with light symbol, screwless
white	SDN0800121	SDN0900121
cream	SDN0800123	SDN0900123
aluminium	SDN0800160	SDN0900160
titanium	SDN0800168	SDN0900168
beige	SDN0800147	SDN0900147
graphite	SDN0800170	SDN0900170
Colour	2-way screwless	
white	SDN0420121	
cream	SDN0420123	
aluminium	SDN0420160	
titanium	SDN0420168	
beige	SDN0420147	
graphite	SDN0420170	

IP44 10 A - 250 V AC push-buttons

Colour	1-way, with bell symbol, screwless	1-way, with light symbol, screwless
white	SDN0800321	SDN0900321
cream	SDN0800323	SDN0900323
aluminium	SDN0800360	SDN0900360
titanium	SDN0800368	SDN0900368
beige	SDN0800347	SDN0900347
graphite	SDN0800370	SDN0900370



10 A - 250 V AC push-buttons with blue locator lamp

Colour	1-way, screwless	
white	SDN1600121	
cream	SDN1600123	
aluminium	SDN1600160	
titanium	SDN1600168	
beige	SDN1600147	
graphite	SDN1600170	
Colour	2-way, screwless	
white	SDN1520121	
cream	SDN1520123	
aluminium	SDN1520160	
titanium	SDN1520168	
beige	SDN1520147	
graphite	SDN1520170	
Colour	1-way, with bell symbol, screwless	1-way, with light symbol, screwless
white	SDN1600421	SDN1800121
cream	SDN1600423	SDN1800123
aluminium	SDN1600460	SDN1800160
titanium	SDN1600468	SDN1800168
beige	SDN1600447	SDN1800147
graphite	SDN1600470	SDN1800170
Colour	1-way, with label holder, screwless	
white	SDN1600321	
cream	SDN1600323	
aluminium	SDN1600360	
titanium	SDN1600368	
beige	SDN1600347	
graphite	SDN1600370	

10 A - 12 V AC push-buttons with blue locator lamp

Colour	1-way, with bell symbol, screwless	
white	SDN1700121	
cream	SDN1700123	
aluminium	SDN1700160	
titanium	SDN1700168	
beige	SDN1700147	
graphite	SDN1700170	
Colour	1-way, with label holder, screwless	
white	SDN1700421	
cream	SDN1700423	
aluminium	SDN1700460	
titanium	SDN1700468	
beige	SDN1700447	
graphite	SDN1700470	

Comfort controls

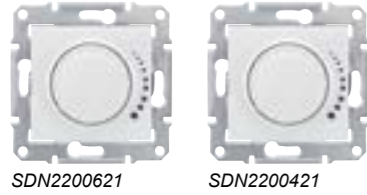

SDN2200621 SDN2200421

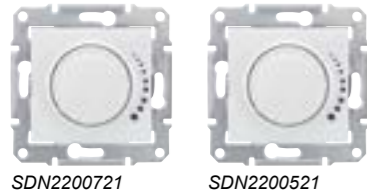

SDN2200721 SDN2200521



SDN2200921



SDN2201221

Colour	RC, 230 V, 25-325 VA	RL, 230 V, 60-500 VA
white	SDN2200621	SDN2200421
cream	SDN2200623	SDN2200423
aluminium	SDN2200660	SDN2200460
titanium	SDN2200668	SDN2200468
beige	SDN2200647	SDN2200447
graphite	SDN2200670	SDN2200470

Colour	RC, 230 V, 25-325 VA, two-way	RL, 230 V, 60-500 VA, two-way
white	SDN2200721	SDN2200521
cream	SDN2200723	SDN2200523
aluminium	SDN2200760	SDN2200560
titanium	SDN2200768	SDN2200568
beige	SDN2200747	SDN2200547
graphite	SDN2200770	SDN2200570

Colour	RL, 230 V, 1000 VA
white	SDN2200921
cream	SDN2200923
aluminium	SDN2200960
titanium	SDN2200968
beige	SDN2200947
graphite	SDN2200970

- with an additional switch output which enables an additional load to be switched on and off
- minimum brightness setting.

Colour	RL-RC, 230 V, 4-400 VA, two-way
white	SDN2201221
cream	SDN2201223
aluminium	SDN2201260
titanium	SDN2201268
beige	SDN2201247
graphite	SDN2201270

Load table

SDN22006XX	SDN22004XX	SDN22009XX	SDN22007XX	SDN22005XX	SDN22012XX	
25-325 W	60-500 W	40-1000 W	25-325 W	60-500 W	4-400 W	incandescent lamps
25-325 W	60-500 W	40-1000 W	25-325 W	60-500 W	4-400 W	230 V AC halogen lamps
	60-500 VA	60-1000 VA		60-500 VA	4-400 VA	230 V/12 V AC halogen lamps with ferromagnetic transformer
25-325 VA			25-325 VA		4-400 VA	230 V/12 V AC halogen lamps with electronic transformer
					4-400 VA	230 V/12 V AC halogen lamps with toroidal transformer
		60-600 W				230 V AC single-phase motors
					4-200 VA	LED lamps (RC-mode)
					4-40 VA	LED lamps (RL-LED-mode)
						Fuse
						2.5 A(H)
						Electronic

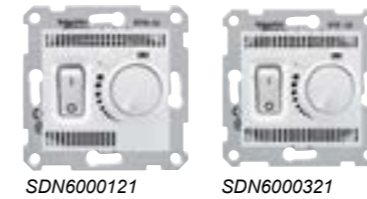

SDN6000121 SDN6000321



SDN6001121



SDN2710221



SDN2720221

Thermostats

Colour	10 A - 230 V AC, room thermostat	10 A - 230 V AC, floor thermostat
white	SDN6000121	SDN6000321
cream	SDN6000123	SDN6000323
aluminium	SDN6000160	SDN6000360
titanium	SDN6000168	SDN6000368
beige	SDN6000147	SDN6000347
graphite	SDN6000170	SDN6000370

- Delivered with 4.0 m sensor
- External sensor: NTC 10 kΩ at 25 °C

Colour	10 A - 230 V AC, room thermostat with cooling mode
white	SDN6001121

Complete assembled products. Can not be used in multigang frame installation

USB chargers

Colour	Double USB chargers, 2.1 A, A + A
white	SDN2710221
cream	SDN2710223
aluminium	SDN2710260
titanium	SDN2710268
beige	SDN2710247
graphite	SDN2710270

Colour	Double USB chargers, 2.4 A, A + C
white	SDN2720221
cream	SDN2720223
aluminium	SDN2720260
titanium	SDN2720268
beige	SDN2720247
graphite	SDN2720270

- Nominal input voltage: 100-240 V AC ±10 %
- USB output voltage: 5 V DC ± 5 %
- Nominal output current: 1 x 2.1 A or 2 x 1.05 A (for 2 outputs) for SDN27102xx
- Nominal output current: 1 x 2.4 A or 2 x 1.2 A (for 2 outputs) for SDN27202xx
- Power consumption: < 0.1 W (in stand-by)
- Maximum output power: 10.5 W for SDN27102xx
- Maximum output power: 12 W for SDN27202xx
- Expected lifetime: 30 000 h for output power 10.5 W
- Overtoltage category: OVC III
- Isolation class: class II

Sedna

Mechanisms

without cover frame

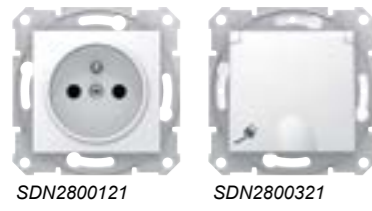
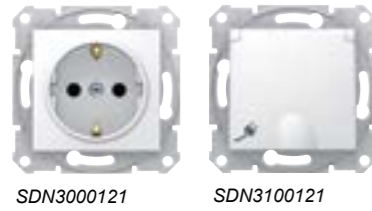

Socket-outlets

Side earth socket-outlets

Colour	16 A - 250 V AC, 2P+E, shuttered, lift terminals	16 A - 250 V AC, 2P+E, shuttered, screwless	16 A - 250 V AC, 2P+E, shuttered, lift terminals, with lid	16 A - 250 V AC, 2P+E, shuttered, screwless, with lid
white	SDN3000121	SDN3001721	SDN3100121	SDN3100421
cream	SDN3000123	SDN3001723	SDN3100123	SDN3100423
aluminium	SDN3000160	SDN3001760	SDN3100160	SDN3100460
titanium	SDN3000168	SDN3001768	SDN3100168	SDN3100468
beige	SDN3000147	SDN3001747	SDN3100147	SDN3100447
graphite	SDN3000170	SDN3001770	SDN3100170	SDN3100470
red	SDN3000341			
Colour	16 A - 250 V AC, 2P+E, lift terminals	16 A - 250 V AC, 2P+E, screwless	16 A - 250 V AC, 2P+E, shuttered, lift terminals, with lid	16 A - 250 V AC, 2P+E, IP44, shuttered, screwless, with lid
white	SDN3000521	SDN3001821	SDN3100321	SDN3100521
cream	SDN3000523	SDN3001823	SDN3100323	SDN3100523
aluminium	SDN3000560	SDN3001860	SDN3100360	SDN3100560
titanium	SDN3000568	SDN3001868	SDN3100368	SDN3100568
beige	SDN3000547	SDN3001847	SDN3100347	SDN3100547
graphite	SDN3000570	SDN3001870	SDN3100370	SDN3100570

Pin earth socket-outlets

Colour	16 A - 250 V AC, 2P+E, shuttered, lift terminals	16 A - 250 V AC, 2P+E, shuttered screwless	16 A - 250 V AC, 2P+E, IP44, shuttered, lift terminals, with lid	16 A - 250 V AC, 2P+E, IP44, shuttered, screwless, with lid
white	SDN2800121	SDN2800721	SDN2800321	SDN2800821
cream	SDN2800123	SDN2800723	SDN2800323	SDN2800823
aluminium	SDN2800160	SDN2800760	SDN2800360	SDN2800860
titanium	SDN2800168	SDN2800768	SDN2800368	SDN2800868
beige	SDN2800147	SDN2800747	SDN2800347	SDN2800847
graphite	SDN2800170	SDN2800770	SDN2800370	SDN2800870
red	SDN2800441			

Socket-outlets without earth

Colour	16 A - 250 V AC, 2P, lift terminals	16 A - 250 V AC, 2P, screwless
white	SDN2900121	SDN2900221
cream	SDN2900123	SDN2900223
aluminium	SDN2900160	SDN2900260
titanium	SDN2900168	SDN2900268
beige	SDN2900147	SDN2900247
graphite	SDN2900170	SDN2900270

Double socket-outlet with pin earth - PL standard - multigang

Colour	16 A - 250 V AC, 2P+E, lift terminals
white	SDN2800921
cream	SDN2800923
aluminium	SDN2800960
titanium	SDN2800968
graphite	SDN2800970

Sedna

Mechanisms

without cover frame

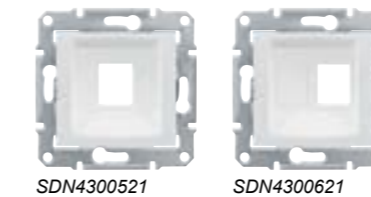
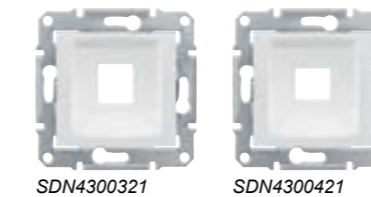
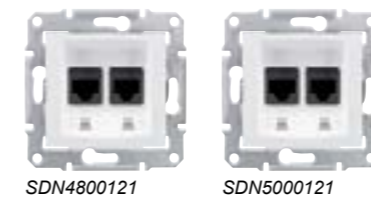
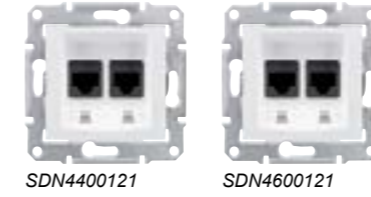
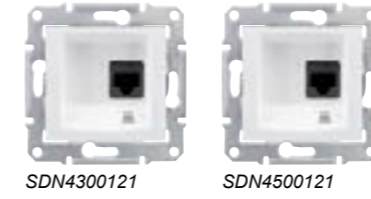

Data outlets

RJ45 category 5e

Colour	1 x RJ45, cat. 5e, UTP, IDC*	1 x RJ45, cat. 5e, STP, IDC*
white	SDN4300121	SDN4500121
cream	SDN4300123	SDN4500123
aluminium	SDN4300160	SDN4500160
titanium	SDN4300168	SDN4500168
beige	SDN4300147	SDN4500147
graphite	SDN4300170	SDN4500170
Colour	2 x RJ45, cat. 5e, UTP, IDC*	2 x RJ45, cat. 5e, STP, IDC*
white	SDN4400121	SDN4600121
cream	SDN4400123	SDN4600123
aluminium	SDN4400160	SDN4600160
titanium	SDN4400168	SDN4600168
beige	SDN4400147	SDN4600147
graphite	SDN4400170	SDN4600170

RJ45 category 6

Colour	1 x RJ45, cat. 6, UTP, IDC*	1 x RJ45, cat. 6, STP, IDC*
white	SDN4700121	SDN4900121
cream	SDN4700123	SDN4900123
aluminium	SDN4700160	SDN4900160
titanium	SDN4700168	
beige	SDN4700147	SDN4900147
graphite	SDN4700170	SDN4900170
Colour	2 x RJ45, cat. 6, UTP, IDC*	2 x RJ45, cat. 6, STP, IDC*
white	SDN4800121	SDN5000121
cream	SDN4800123	SDN5000123
aluminium	SDN4800160	SDN5000160
titanium	SDN4800168	
beige	SDN4800147	SDN5000147
graphite	SDN4800170	SDN5000170

* IDC: Insulation Displacement Connection in RJ45 connectors.

Plate for 1 x RJ45 without connectors

Colour	KRONE, cat. 5e, cat. 6, UTP	RDM, cat. 5e, cat. 6, UTP
white	SDN4300321	SDN4300421
cream	SDN4300323	SDN4300423
aluminium	SDN4300360	SDN4300460
titanium		SDN4300468
beige		
graphite	SDN4300370	SDN4300470
Colour	SYSTEMAX, cat. 5e, cat. 6, UTP	AMP, MOLEX, KELINE, cat. 5e, cat. 6, UTP
white	SDN4300521	SDN4300621
cream		SDN4300623
aluminium	SDN4300560	SDN4300660
titanium		SDN4300668
beige		SDN4300647
graphite	SDN4300570	SDN4300670

Plate for 2 x RJ45 without connectors

Colour	AMP, MOLEX, KELINE, cat. 5e, cat. 6, UTP
white	SDN4400621
cream	SDN4400623
aluminium	SDN4400660
titanium	SDN4400668
beige	SDN4400647
graphite	SDN4400670

Telephone outlets

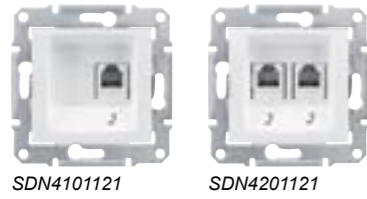

Colour	1 x RJ11, screw terminals	2 x RJ11, screw terminals
white	SDN4101121	SDN4201121
cream	SDN4101123	SDN4201123
aluminium	SDN4101160	SDN4201160
titanium	SDN4101168	SDN4201168
beige	SDN4101147	SDN4201147
graphite	SDN4101170	SDN4201170

Telephone + data outlets



SDN5100121



SDN5200121

Colour	RJ11 + RJ45, cat. 5e, UTP, IDC* + screw terminals	
white	SDN5100121	
cream	SDN5100123	
aluminium	SDN5100160	
titanium	SDN5100168	
beige	SDN5100147	
graphite	SDN5100170	
Colour	RJ11 + RJ45, cat. 6, UTP, IDC* + screw terminals	RJ11 + RJ45, cat. 6, STP, IDC* + screw terminals
white	SDN5200121	
cream	SDN5200123	
aluminium	SDN5200160	
titanium	SDN5200168	
beige	SDN5200147	SDN5200247
graphite	SDN5200170	

* IDC: Insulation Displacement Connection in RJ45 connectors.

TV/R/SAT outlets

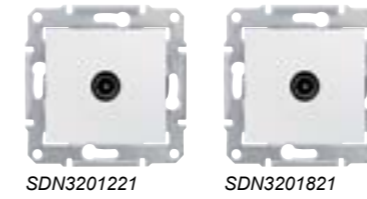

SDN3201221

SDN3201821



SDN3201621

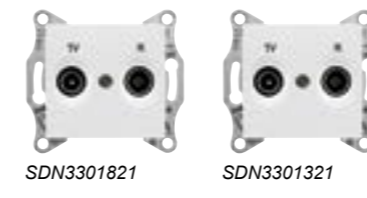

SDN3301821

SDN3301321

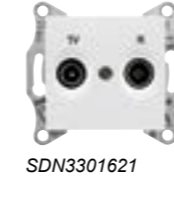

SDN3301621

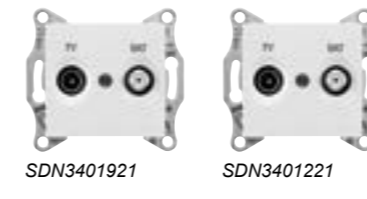

SDN3401921

SDN3401221

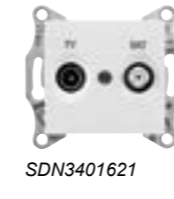

SDN3401621

Colour	TV connector, intermediate, 4 dB	TV connector, intermediate, 8 dB
white	SDN3201821	SDN3201221
cream	SDN3201823	SDN3201223
aluminium	SDN3201860	SDN3201260
titanium	SDN3201847	SDN3201268
beige	SDN3201870	SDN3201247
graphite	SDN3201870	SDN3201270
Colour	TV connector ending, 1 dB	
white	SDN3201621	
cream	SDN3201623	
aluminium	SDN3201660	
titanium	SDN3201668	
beige	SDN3201647	
graphite	SDN3201670	

Colour	TV/R outlet, intermediate, 4 dB	TV/R outlet, intermediate, 8 dB
white	SDN3301821	SDN3301321
cream	SDN3301823	SDN3301323
aluminium	SDN3301860	SDN3301360
titanium	SDN3301868	SDN3301368
beige	SDN3301847	SDN3301347
graphite	SDN3301870	SDN3301370
Colour	TV/R outlet, ending, 1 dB	
white	SDN3301621	
cream	SDN3301623	
aluminium	SDN3301660	
titanium	SDN3301668	
beige	SDN3301647	
graphite	SDN3301670	

Colour	TV/SAT outlet, intermediate, 4 dB	TV/SAT outlet, intermediate, 8 dB
white	SDN3401921	SDN3401221
cream	SDN3401923	SDN3401223
aluminium	SDN3401960	SDN3401260
titanium	SDN3401968	SDN3401268
beige	SDN3401947	SDN3401247
graphite	SDN3401970	SDN3401270
Colour	TV/SAT outlet, ending, 1 dB	
white	SDN3401621	
cream	SDN3401623	
aluminium	SDN3401660	
titanium	SDN3401668	
beige	SDN3401647	
graphite	SDN3401670	

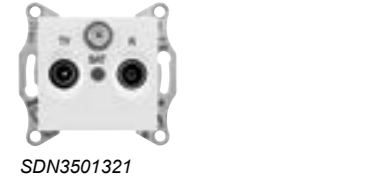
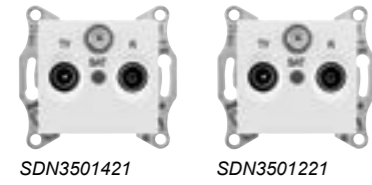

TV/R/SAT outlets (cont'd)

TV/R/SAT

Colour	TV/R/SAT outlet, intermediate, 4 dB	TV/R/SAT outlet, intermediate, 8 dB
white	SDN3501421	SDN3501221
cream	SDN3501423	SDN3501223
aluminium	SDN3501460	SDN3501260
titanium	SDN3501468	SDN3501268
beige	SDN3501447	SDN3501247
graphite	SDN3501470	SDN3501270

Colour	TV/R/SAT outlet, ending, 1 dB
white	SDN3501321
cream	SDN3501323
aluminium	SDN3501360
titanium	SDN3501368
beige	SDN3501347
graphite	SDN3501370

TV/SAT/SAT

Colour	TV/SAT/SAT outlet, ending, 1 dB
white	SDN3502121
cream	SDN3502123
aluminium	SDN3502160
titanium	SDN3502168
beige	SDN3502147
graphite	SDN3502170

Colour	TV/R center plates	TV/SAT center plates
white	SDN3311321	SDN3411221
cream		
aluminium	SDN3311360	SDN3411260
titanium		
beige		
graphite	SDN3311370	SDN3411270

Loudspeaker outlet

Colour	Double loudspeaker outlet, screwless
white	SDN5400121
cream	SDN5400123
aluminium	SDN5400160
titanium	SDN5400168
beige	SDN5400147
graphite	SDN5400170

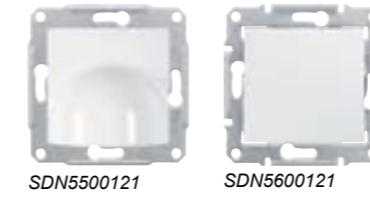

Complementary offers

Colour	Cable outlet 250 V - 25 A
white	SDN5500121
cream	SDN5500123
aluminium	SDN5500160
titanium	SDN5500168
beige	SDN5500147
graphite	SDN5500170

Colour	Blind cover
white	SDN5600121
cream	SDN5600123
aluminium	SDN5600160
titanium	SDN5600168
beige	SDN5600147
graphite	SDN5600170

Colour	Night light lamp 250 V - 3 W
white	SDN5900123

LED Modules for switches and push-buttons

Module 1-pole locator lamp	SDN14L0121
Module 2-way, intermediate locator	SDN15L0121
Module 2-circuit locator	SDN03L0121
Module indicator lamp	SDN04L0121
Module 12V push-button locator lamp	SDN17L0121
Module card switch locator	SDN19L0121

Spare parts - White rockers for switches and push-buttons

Single rocker	SDN01R0121
Double rocker	SDN03R0121
Single rocker with locator/indicator	SDN14R0121
Double rocker with locator/indicator	SDN03R1121
Double rocker for roller blinds and shutters control	SDN13R0121



SDN0400821



SDN3000821



SDN3000421



SDN2800521



SDN2800621

Switches

1 pole 2 way switch

Colour	10 AX with frame white
<input type="checkbox"/> white	SDN0400821

Socket-outlets

Single socket-outlet, side earth

Colour	16 A shutters, with frame white
<input type="checkbox"/> white	SDN3000821

Double socket-outlet with side earth

Colour	16 A - 250 V AC, 2P+E, shuttered with lift terminals
<input type="checkbox"/> white	SDN3000421
<input type="checkbox"/> cream	SDN3000423
<input type="checkbox"/> aluminium	SDN3000460
<input type="checkbox"/> titanium	SDN3000468
<input type="checkbox"/> beige	SDN3000447
<input type="checkbox"/> graphite	SDN3000470

Double socket-outlet with pin earth - CZ, SK standard

Colour	16 A - 250 V AC, 2P+E, shuttered with lift terminals
<input type="checkbox"/> white	SDN2800521
<input type="checkbox"/> cream	SDN2800523
<input type="checkbox"/> aluminium	SDN2800560
<input type="checkbox"/> titanium	SDN2800568
<input type="checkbox"/> beige	SDN2800547
<input type="checkbox"/> graphite	SDN2800570

Double socket-outlet with pin earth - PL standard

Colour	16 A - 250 V AC, 2P+E, shuttered with lift terminals
<input type="checkbox"/> white	SDN2800621
<input type="checkbox"/> cream	SDN2800623
<input type="checkbox"/> aluminium	SDN2800660
<input type="checkbox"/> titanium	SDN2800668
<input type="checkbox"/> graphite	SDN2800670

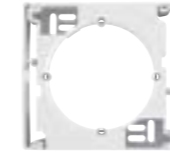

SDN6100121

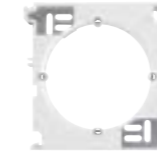

SDN6100221

Horizontal surface mounting boxes

Colour	1 gang	Multi-gang, universal
<input type="checkbox"/> white	SDN6100121	SDN6100221
<input type="checkbox"/> cream	SDN6100123	SDN6100223
<input type="checkbox"/> aluminium	SDN6100160	SDN6100260
<input type="checkbox"/> titanium	SDN6100168	SDN6100268
<input type="checkbox"/> beige	SDN6100147	SDN6100247
<input type="checkbox"/> graphite	SDN6100170	SDN6100270
		2-gang box: SDN61001xx + SDN61002xx
		3-gang box: SDN61001xx + 2 x SDN61002xx



Colour	1 gang	1 gang- IP 44
white	SDN5800121	SDN5810521
cream	SDN5800123	SDN5810523
aluminium	SDN5800160	SDN5810560
titanium	SDN5800168	SDN5810568
beige	SDN5800147	SDN5810547
graphite	SDN5800170	SDN5810570
grey	SDN5800133	
red	SDN5800141	
2 gang horizontal frame		
white	SDN5800321	SDN5810621
cream	SDN5800323	SDN5810623
aluminium	SDN5800360	SDN5810660
titanium	SDN5800368	SDN5810668
beige	SDN5800347	SDN5810647
graphite	SDN5800370	SDN5810670
grey	SDN5800333	
red	SDN5800341	
2 gang vertical frame		
white	SDN5801121	
cream	SDN5801123	
aluminium	SDN5801160	
titanium	SDN5801168	
beige	SDN5801147	
graphite	SDN5801170	
grey	SDN5801133	
red	SDN5801141	
3 gang horizontal frame		
white	SDN5800521	SDN5810721
cream	SDN5800523	SDN5810723
aluminium	SDN5800560	SDN5810760
titanium	SDN5800568	SDN5810768
beige	SDN5800547	SDN5810747
graphite	SDN5800570	SDN5810770
grey	SDN5800533	
red	SDN5800541	
3 gang vertical frame		
white	SDN5801321	
cream	SDN5801323	
aluminium	SDN5801360	
titanium	SDN5801368	
beige	SDN5801347	
graphite	SDN5801370	
grey	SDN5801333	
red	SDN5801341	
4 gang horizontal frame		
white	SDN5800721	
cream	SDN5800723	
aluminium	SDN5800760	
titanium	SDN5800768	
beige	SDN5800747	
graphite	SDN5800770	
grey	SDN5800733	
red	SDN5800741	
4 gang vertical frame		
white	SDN5802021	
cream	SDN5802023	
aluminium	SDN5802060	
titanium	SDN5802068	
beige	SDN5802047	
graphite	SDN5802070	
grey	SDN5802033	
red	SDN5802041	



Colour	5 gang horizontal frame
white	SDN5800921
cream	SDN5800923
aluminium	SDN5800960
titanium	SDN5800968
beige	SDN5800947
graphite	SDN5800970
grey	SDN5800933
red	SDN5800941
5 gang vertical frame	
white	SDN5801521
cream	SDN5801523
aluminium	SDN5801560
titanium	SDN5801568
beige	SDN5801547
graphite	SDN5801570
grey	SDN5801533
red	SDN5801541

Switches and push-buttons connection examples

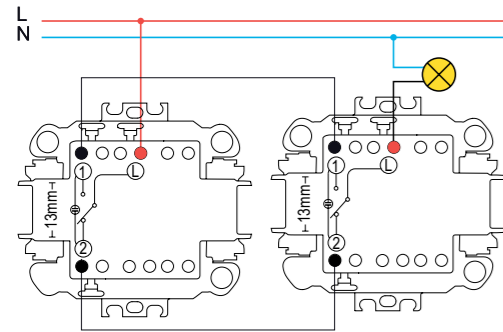

2 two-way switches or 2 two-way switches with locator lamp

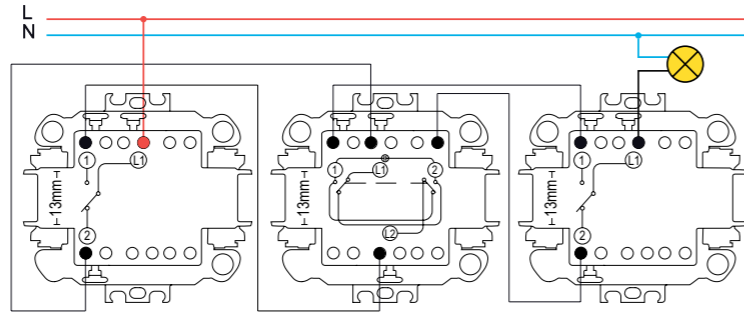

2 two-way switches or 2 two-way switches with locator lamp + 1 intermediate switch

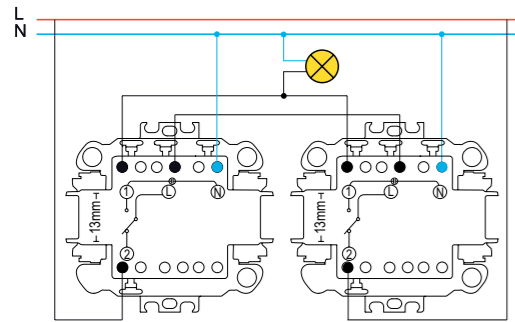

2 two-way switches with indicator lamp

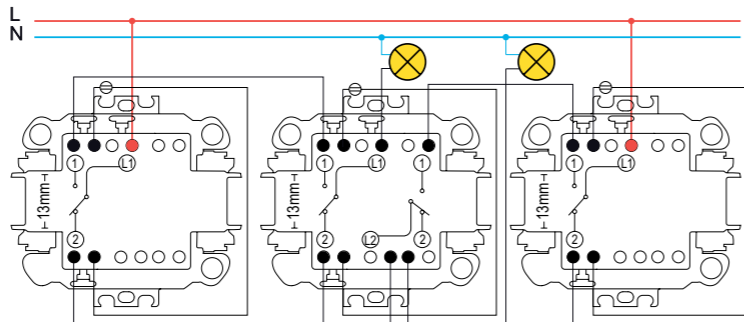

2 two-way switches + 1 double two-way switches

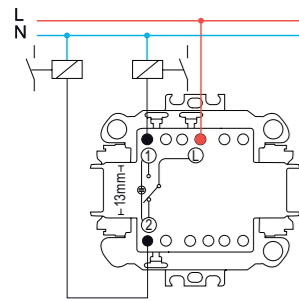

Two-way push-button or two-way push-button with locator lamp

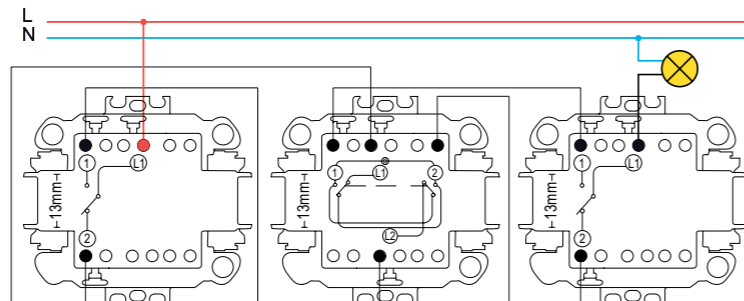

2 two-way switches + 1 intermediate switch with locator lamp

Dimensions (mm)

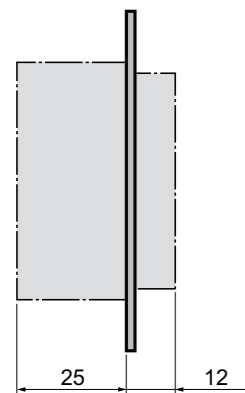

Rotary dimmers RC, 25-325 VA - SDN22006XX

Area of application

- Regulation of different loads (see load table) for homes and buildings.
- Suitable for renovation as it allows replacement of a switch by a regulator without having to change cables.
- As the regulator reduces the current supplying the load, it allows considerable energy savings.

Technical data

- Rated voltage: 230 V AC \pm 10 %, 50 Hz,
- Connectable as switch,
- IP degree of protection: IP20,
- Conformity mark: CE,
- Standard: EN 60669-2-1.

Load table

	1	2	3	4
25°C 230 V 50 Hz				
Max.	325 W	325 W	NO	325 VA
Min.	25 W	25 W		25 VA

- 1 - Incandescent lamps
- 2 - Halogen lamps
- 3 - Low voltage halogen lamps with ferromagnetic transformer
- 4 - Low voltage halogen lamps with electronic transformers

Connections

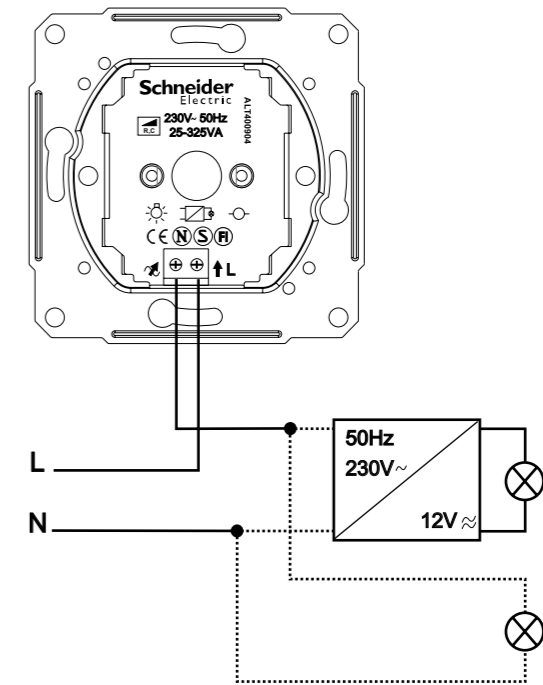

Dimensions (mm)

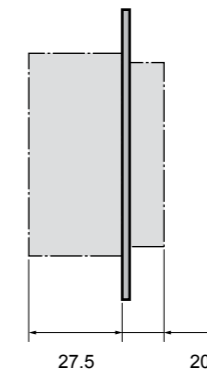

Rotary dimmers RL, 60-500 VA - SDN22004XX

Area of application

- Regulation of different loads (see load table) for homes and buildings.
- Suitable for renovation as it allows replacement of a switch by a regulator without having to change cables.
- As the regulator reduces the current supplying the load, it allows considerable energy savings.

Technical data

- Rated voltage: 230 V AC \pm 10 %, 50 Hz,
- Connectable as switch,
- IP degree of protection: IP20,
- Conformity mark: CE,
- Standard: EN 60669-2-1.

Load table

	1	2	3	4
25°C 230 V 50 Hz				
Max.	500 W	500 W	500 VA	NO
Min.	60 W	60 W	60 VA	

- 1 - Incandescent lamps
- 2 - Halogen lamps
- 3 - Low voltage halogen lamps with ferromagnetic transformer
- 4 - Low voltage halogen lamps with electronic transformers

Connections

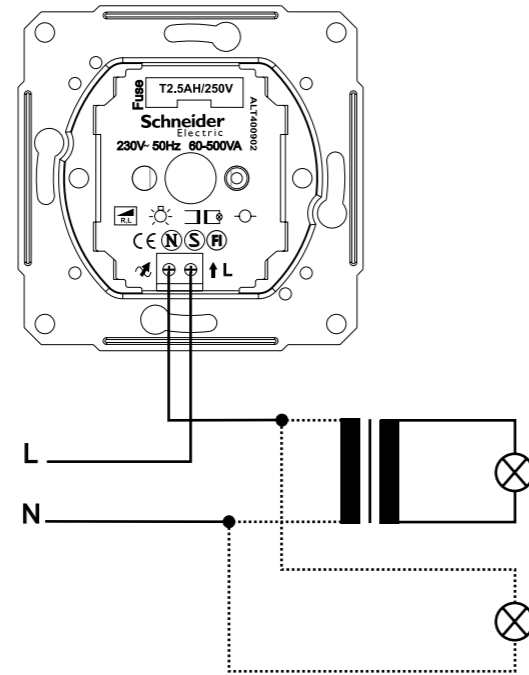

Dimensions (mm)

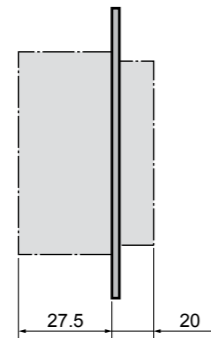

Rotary push-button dimmers RL, 230 V, 1000 VA - SDN22009XX

Area of application

- Regulation of different loads (see load table) for homes and buildings.
- As the regulator reduces the current supplying the load, it allows considerable energy savings.
- A comfort feature: setting minimum brightness level.
- Additional ON/OFF supply possibility to additional load with separated terminal output.

Technical data

- Rated voltage: 230 V AC \pm 10 %, 50 Hz
- Load on the switch output: max. 2 A, $\cos \phi$ 0.6,
- IP degree of protection: IP20,
- Conformity mark: CE,
- Standard: EN 60669-2-1.

Load table

	1	2	3	4	5
25°C 230 V 50 Hz					
Max.	1000 W	1000 W	1000 VA	NO	600 VA
Min.	40 W	40 W	60 VA		

- 1 - Incandescent lamps
- 2 - Halogen lamps
- 3 - Low voltage halogen lamps with ferromagnetic transformer
- 4 - Low voltage halogen lamps with electronic transformers
- 5 - Single-phase motors

Installation

The maximum allowed load is reduced due to the decreased heat dissipation when you do not install the device into a single standard flushmounting box:

Load reduction by	Mounted in cavity walls*	Several installed together in combination*	In 1-gang or 2-gang surface-mounted housing	In 3-gang surface-mounted housing
25 %	■	■		
30 %			■	
50 %				■

* If several factors apply, add the load reductions together.

Installing the dimmer and covers

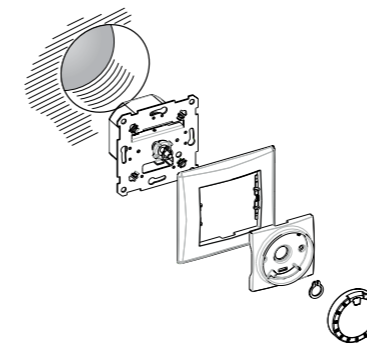

Use

Setting the minimum brightness of the lamps

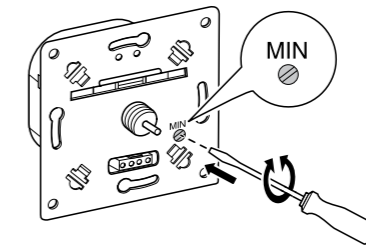

- 1 Set the dimmer.
- 2 Dim the brightness right down using the rotary knob.
- 3 Set the minimum brightness using the set-screw (MIN).

Operating the dimmer

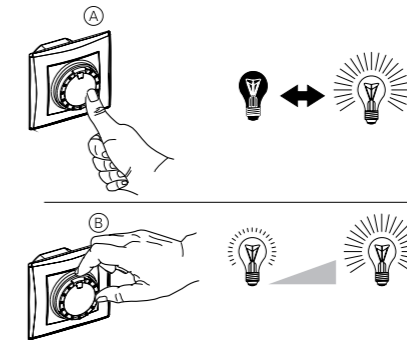

You switch the connected lamps on and off by simply pressing the rotary knob (A). By turning the rotary knob (B), you dim the lamps brighter or darker.

Connections

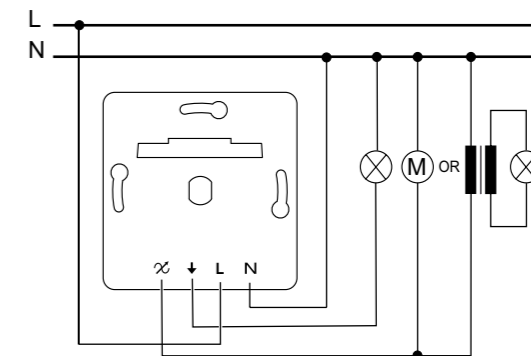

∞ : controlled/dimmed output
↓ : ON/OFF output

Dimensions (mm)

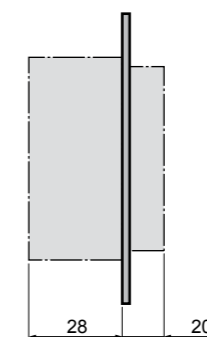

Rotary push-button dimmers RC, 25-325 VA, two-way - SDN22007XX

Area of application

- Regulation of different loads (see load table) for homes and buildings.
- Suitable for renovation as it allows replacement of a switch or a 2-way switch by a regulator without having to change cables.
- As the regulator reduces the current supplying the load, it allows considerable energy savings.

Technical data

- Rated voltage: 230 V AC ± 10 %, 50 Hz,
- Possibility of connection with a two-way switch or just replace one-way switch,
- IP degree of protection: IP20,
- Conformity mark: CE,
- Standard: EN 60669-2-1.

Load table

	1	2	3	4
25°C 230 V 50 Hz				
Max.	325 W	325 W	NO	325 VA
Min.	25 W	25 W		25 VA

- 1 - Incandescent lamps
- 2 - Halogen lamps
- 3 - Low voltage halogen lamps with ferromagnetic transformer
- 4 - Low voltage halogen lamps with electronic transformers

Connections

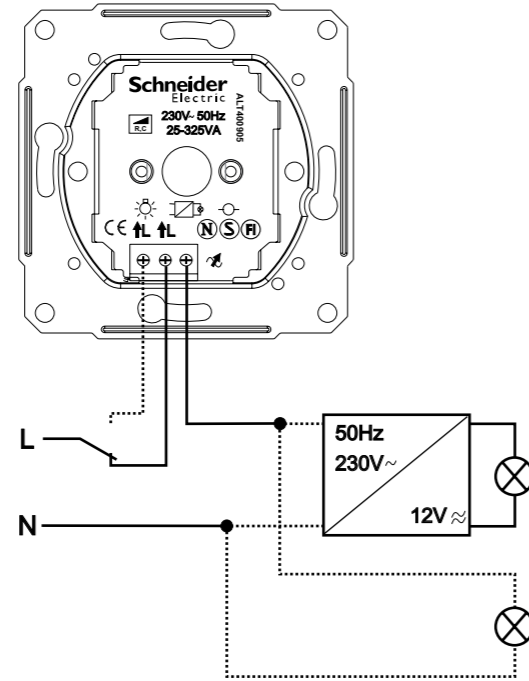

Dimensions (mm)

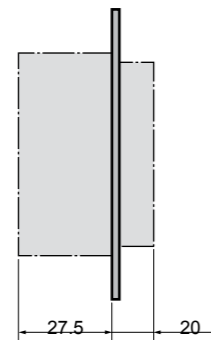

Rotary push-button dimmers RL, 60-500 VA, two-way - SDN22005XX

Area of application

- Regulation of different loads (see load table) for homes and buildings.
- Suitable for renovation as it allows replacement of a switch or a 2-way switch by a regulator without having to change cables.
- As the regulator reduces the current supplying the load, it allows considerable energy savings.

Technical data

- Rated voltage: 230 V AC ± 10 %, 50 Hz,
- Possibility of connection with a two-way switch or just replace one-way switch,
- Fuse: 2,5 A(H)-230 V AC,
- IP degree of protection: IP20,
- Conformity mark: CE,
- Standard: EN 60669-2-1.

Load table

	1	2	3	4
25°C 230 V 50 Hz				
Max.	500 W	500 W	500 VA	NO
Min.	60 W	60 W	60 VA	

- 1 - Incandescent lamps
- 2 - Halogen lamps
- 3 - Low voltage halogen lamps with ferromagnetic transformer
- 4 - Low voltage halogen lamps with electronic transformers

Connections

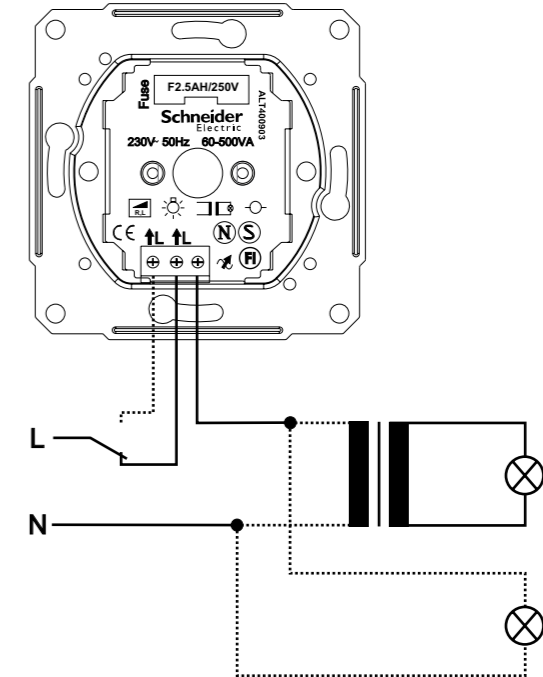

Dimensions (mm)

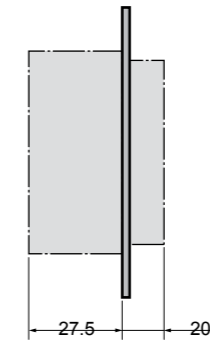

Rotary push-button dimmers RL-RC, 230 V, 4-400 VA, two-way - SDN22012XX

Area of application

- Regulation of different loads (see load table) for homes and buildings.
- Suitable for renovation as it allows replacement of a switch or a 2-way switch by a regulator without having to change cables.
- As the regulator reduces the current supplying the load, it allows considerable energy savings.

Technical data

- Rated voltage: 230 V AC \pm 10 %, 50 Hz,
- Possibility of connection with a two-way switch or just replace one-way switch,
- Switch type: 6 / 1,
- IP degree of protection: IP20,
- Conformity mark: CE,
- Standard: EN 60669-2-1,
- Product certification: FIMKO, NEMKO, SEMKO, VDE.

Load table

	1	2	3	4	5	6
25°C 230 V 50 Hz						
Max.	400 W	400 W	400 VA	400 VA	400 VA	200 VA
Min.	4 W	4 W	4 VA	4 VA	4 VA	40 VA

- 1 - Incandescent lamps
- 2 - Halogen lamps
- 3 - Low voltage halogen lamps with ferromagnetic transformer
- 4 - Low voltage halogen lamps with electronic transformers
- 5 - Low voltage halogen lamps with toroidal transformers
- 6 - Led lamps

Use

- Dimmer is installed into applicable flush or surface mounted installation box, connections according to the wiring diagram.
- Connected load type (resistive, capacitive and inductive) is detected and regulation algorithm is set automatically by the dimmer. The minimum and maximum light level setting is adjustable. Note: Device is not able to regulate capacitive and inductive loads simultaneously!
- The dimmer is designed using 2-wire topology so it can be used to replace a normal switch.
- Alternative connectors for phase-in (two-way switch used to control light from 2 points) are marked L, and regulated phase out has ∞ -symbol. Xmarked connector is not connected internally to the dimmer and it can be used as extension joint. All connectors are applicable for 2 x 2,5mm² wires.

User interface

Lights are switched ON / OFF by pushing the knob and light level is regulated by turning the knob. The dimmer uses soft start function when lights are switched ON.

Protections

The dimmer has electronic protection against the short circuit, over voltage, overload and overheat. If electronic protection has activated, to reset the dimmer for normal operation, push the knob. The dimmer also contains single shot thermal fuse.

Connections

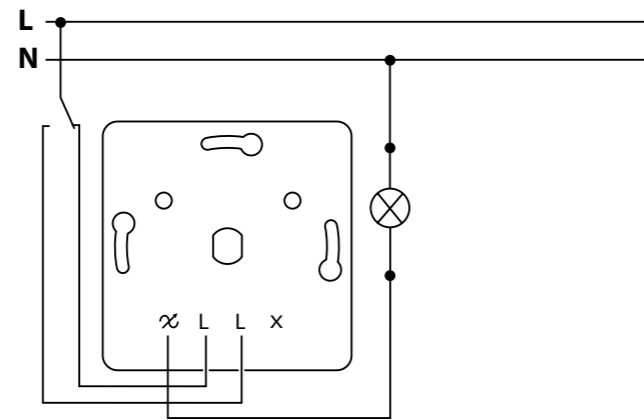

Dimensions (mm)

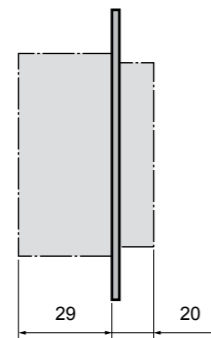

Thermostat 10 A, room thermostat - SDN60001XX

Area of application

Electronic room thermostat is designed for controlling electric heaters like radiators and ceiling heaters. Room thermostat is easy to use and install. It includes ON/OFF switch in front panel and trimmer for temperature set point selection. It has one led to indicate when load is connected. Thermostat full fills EN-60730-2-9 standard and it is RoHS and REACH compliant.

Technical data

- Voltage range: 230 V ac \pm 10 %, 50 Hz,
- Max fuse: 16 A,
- Maximum load: 2300 W (10 A, 230 V, cos ϕ = 1),
- Operation temperature: + 5 °C to + 30 °C,
- Temperature control range: + 5 °C to + 30 °C,
- Storage temperature: - 20 °C to + 60 °C
- Control accuracy: 1 °C,
- 2-pole switch in front panel,
- Relay: NO (normally open),
- Led: red,
- Wires/terminal: max 2 x 2,5 mm²
- Terminals have wire protectors (for multicore cables),
- IP degree of protection: IP20,
- Conformity mark: CE,
- Standard: EN 60669-2-1.

Use

- Put thermostat ON/OFF from the switch in front panel.
- Red light indicates that heating is active.
- Adjusting scale indicates suggestive temperature and suitable temperature should be measured by experience.

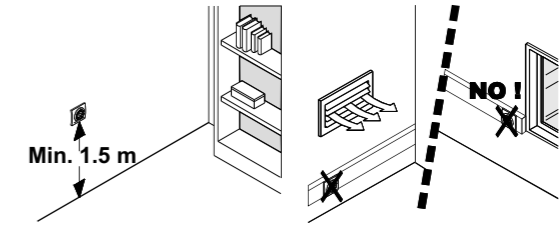

Connections

Put thermostat to a mounting box so that connectors are up. If connection has protective earth (PE) wires use external connectors to connect them together. Thermostat doesn't have terminals for PE.

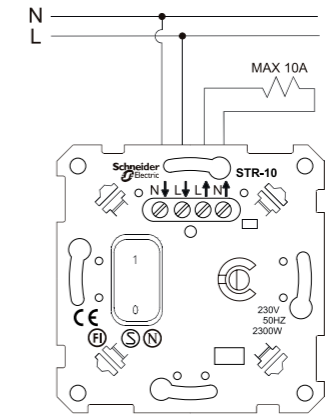

Dimensions (mm)

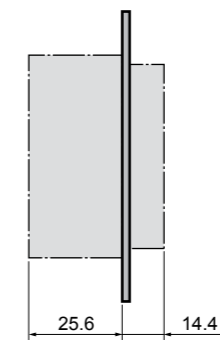

Thermostat 10 A, floor thermostat - SDN60003XX

Area of application

Electronic floor thermostat is designed for floor heating cables and other floor heating applications. Floor thermostat is easy to use and install. It includes ON/OFF switch in front panel and trimmer for temperature set point selection. It has one led to indicate when load is connected. Thermostat full fills EN-60730-2-9 standard and it is RoHS and REACH compliant.

Technical data

- Voltage range: 230 V ac \pm 10 %, 50 Hz,
- Max fuse: 16 A,
- Maximum load: 2300 W (10 A, 230 V, $\cos \varphi = 1$),
- Wires/terminal: max 2 x 2,5 mm²,
- Operation temperature: + 5 °C to + 50 °C,
- Storage temperature: - 20 °C to + 50 °C,
- Temperature control range: + 5 °C to + 50 °C,
- Control accuracy: 1 °C,
- 2-pole switch in front panel,
- Relay: NO (normally open),
- Led: red,
- Terminals have wire protectors (for multicore cables),
- External sensor (attached) 4,0 m double isolated, NTC 10 k Ω at 25 °C,
- IP degree of protection: IP20,
- Conformity mark: CE,
- Standard: EN 60730-2-9.

Use

- Put thermostat ON/OFF from the switch in front panel.
- Red light indicates that heating is active. Warming of the floor takes several hours.
- Adjusting scale indicates suggestive temperature and suitable temperature should be measured by experience.

Connections

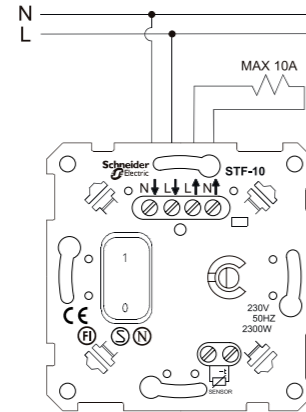

Put thermostat to a mounting box so that connectors are up. If connection has protective earth (PE) wires use external connectors to connect them together. Thermostat doesn't have terminals for PE.

Dimensions (mm)

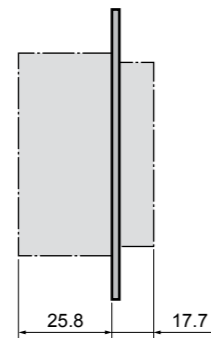

Thermostat 10 A, room thermostat with cooling mode - SDN60011XX

Area of application

Bimetal thermostat with cooling mode can be used to control both heating or cooling systems in dry and closed spaces, such as flats, schools, halls, workshops, etc.

Technical data

- Nominal voltage: 230 V AC
- Temperature adjustment range: 5-30°C
- Nominal current
 - Heating: 10 A resistive and 4 A inductive loads,
 - Cooling: 5 A resistive load and 2 A inductive loads,
- Switching capacity:
 - Heating: 2.2 kW
 - Cooling: 1.1 kW
- Differential gap: approx. 0.5 K
- Maximum humidity: 95 %, no condensation,
- IP degree of protection: IP20,
- Conformity mark: CE,
- Standard: EN 60730-2-9.

Standards

The inserts is interference-suppressed in accordance with EN 55014 and operates according to operating principles 1C.

Connections

Circuit diagram

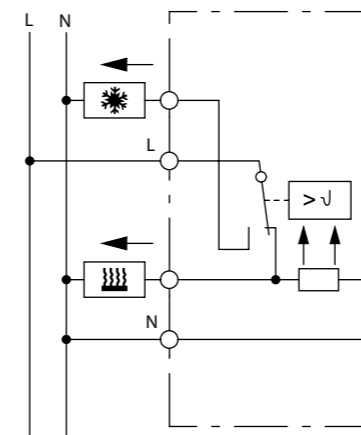

Heating

Cooling

Use

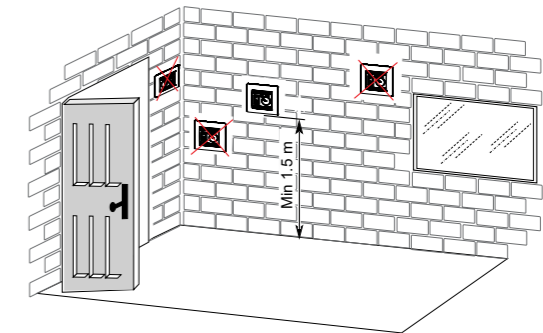

- Installation on interior walls opposite the heat source is preferable
- Mounting height: approx. 1.5 m above the floor
- External walls and draughts from windows and doors should be avoided
- Ensure that the warm air in the room has free access to the controller. Therefore, the controller should not be installed inside shelving units or behind curtains and similar coverings
- External heat affects the accuracy of the control unit adversely. Therefore, avoid direct sunlight, proximity to televisions, radio and heating appliances, lamps, chimneys and heating pipes
- A dimmer also generate heat. If a controller is installed with a dimmer in a shared switch frame, the two should be as far as possible. If they are arranged one on the top of the other, the controller must be below the dimmer.

Commissioning the room temperature control unit

When commissioning the room temperature control unit be aware that the bimetallic element needs time to adjust to the room temperature. Therefore the switching point will deviate from the room temperature directly after installation or after night economy is switched off. The switching points becomes accurate after approx. 1 or 2 hours of operating time. We therefore recommend an initial set temperature that is higher than actually so that initial heating and initial temperature equalisation are faster. After the desired temperature has been reached the temperature setting can be set to the setpoint value required. Use the setting knob to set the temperature required. The scale corresponds to a temperature range of approx. 5 - 30°C.

Dimensions (mm)

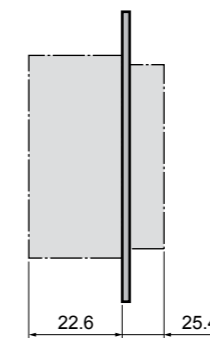

USB chargers

Area of application

USB chargers allow you to quickly charge the battery of a portable device without a mobile charger

Double USB chargers, type A+A, 2.1 A SDN27102XX

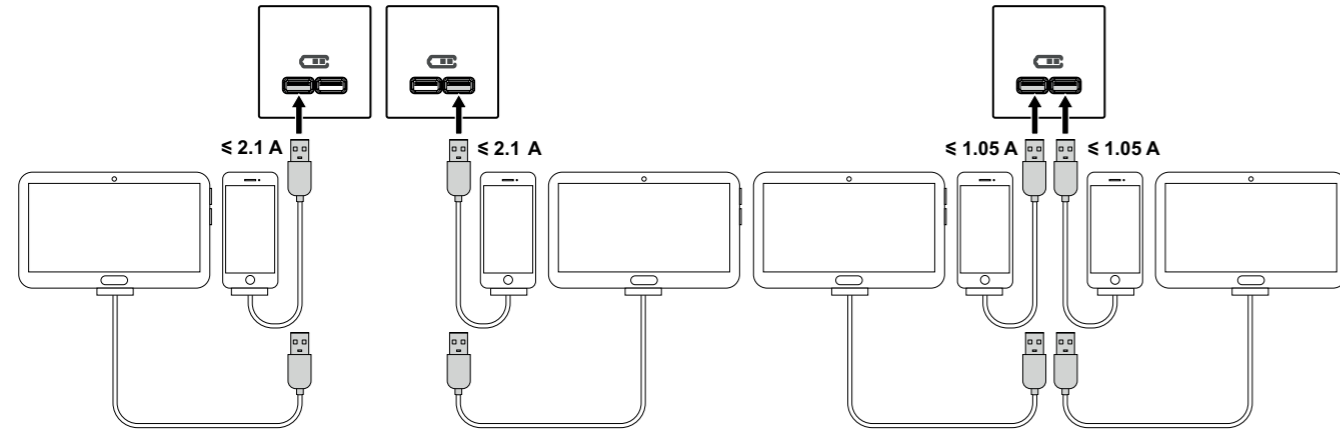

Double USB chargers, type A+C, 2.4 A SDN27202XX

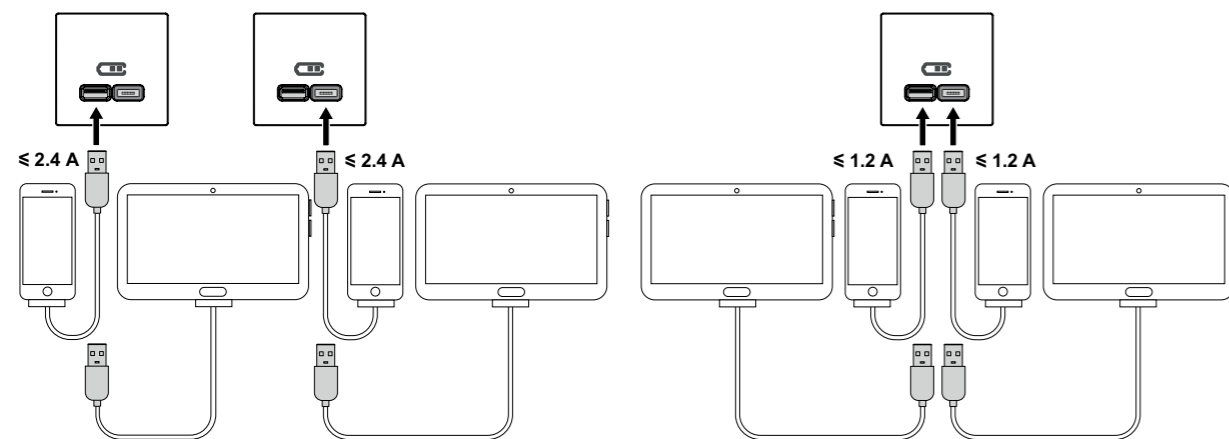

Connection

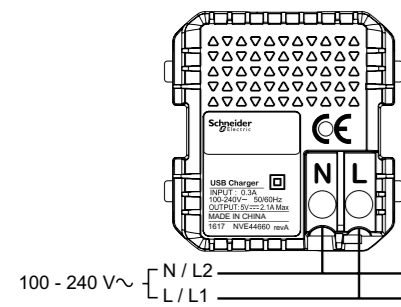

Embedding depth

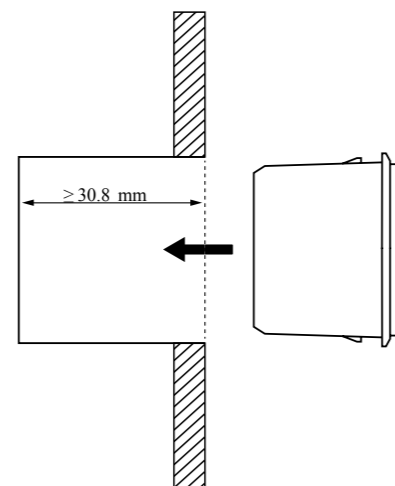

Key card switch SDN19001XX

Area of application

- Particularly recommended for hotel rooms.
- Controls lighting circuits, electrical appliances, electronic equipment, etc.

Technical data

- IP degree of protection: IP20,
- Conformity mark: CE,
- Standard: EN 60669-1,
- Product certifications: S, N, FI.

Connections

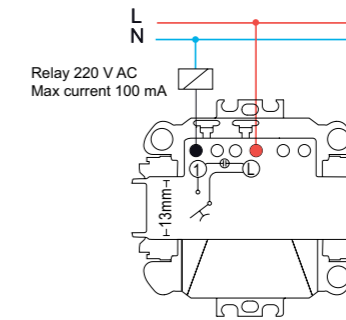

Dimensions (mm)

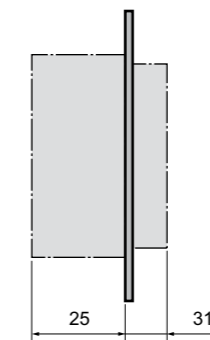

RJ45 data sockets

Area of application

- Given the rapid evolution of the world of computing and telecommunications, today installation of networks is essential in offices and shops (and soon in homes) in order to share information and equipment (printers, scanners, etc.) between several computers.
- These networks consist of cables, connectors, centralising systems and other accessories that, installed in standard, flexible and upgradeable manner (for all Voice, Data, Image transmission applications), make up what is known as structured cabling system.
- The main component of structured cabling is the cable. There are different types of cable for data networks (coaxial, optical fibre, etc.), but the cable most commonly used is the twisted pair cable consisting of 2 insulated and interlaced copper wires.
- There are several types of twisted pair cables:
 - the U/UTP cable (Unshielded Twisted Pair) is a 4-pair twisted cable that is not shielded. It is intended for small and medium installations without electromagnetic pollution
 - the F/UTP cable (Foiled Twisted Pair) is a 4-pair twisted cable with general shielding for external protection, common to all 4 pairs, protecting them against reduced electromagnetic pollution. It is suitable for installations requiring minimum electromagnetic protection
 - the S/FTP cable (Shielded Twisted Pair) is also another 4-pair shielded twisted cable with protective shielding of each pair against high electromagnetic pollution. This minimises emissions. It is suitable for installations requiring a high level of electromagnetic protection.
- The RJ45 socket is an 8-pin connector standardised by ISO8877 for connection of devices to VDI networks.
- One of the standards most commonly used for production of structured cabling is that of the North American Association of electronic and telecommunications manufacturers (EIA/TIA 568B) that has defined a colour code with 2 alternatives, to describe connection of the RJ45 connector.

Technical data

Categories

- The most important property defining a data network is the speed at which information can circulate inside this network.
- According to this aspect, installations are classed into the following categories:

Category	Transmission rate	Network type
Cat. 3	Up to 10 MHz	Ethernet 10 Base T, Token Ring 4 Mbps
Cat. 4	Up to 16 MHz	Token Ring 16 Mbps
Cat. 5e	Up to 100 MHz	Ethernet 1000 Base T, ATM 155 Mbps
Cat. 6	Up to 250 MHz	Ethernet 1000 Base T, ATM 1200
Cat. 6 _A	Up to 500 MHz	Ethernet full-duplex mode 1000 Base T

- So that an installation can be included in a certain category, all the elements making it up must belong to the same category, or, otherwise, it will be classed in the category of the lower category element.

Sedna offer

- The Sedna offer consists of supports for RJ45 connectors and of a broad and comprehensive range.
- This offer satisfies the technical requirements of prevailing regulations soon to be standardised and stand out by the following characteristics:
 - ease of mounting: each connector is equipped with a code of colours and numbers to guide connection at all times without needing special tools
 - high connector quality with category 6 and 6 sockets thus allowing us to propose the quickest connector on the market
 - minimum conductor untwisting for connection, thus preventing electromagnetic interference
 - connection reliability
 - compact size (particularly for the shielded version).

RJ45 data sockets (cont'd)

Installation

Example of unshielded data socket installation (cat 6_A, 5, 5e)

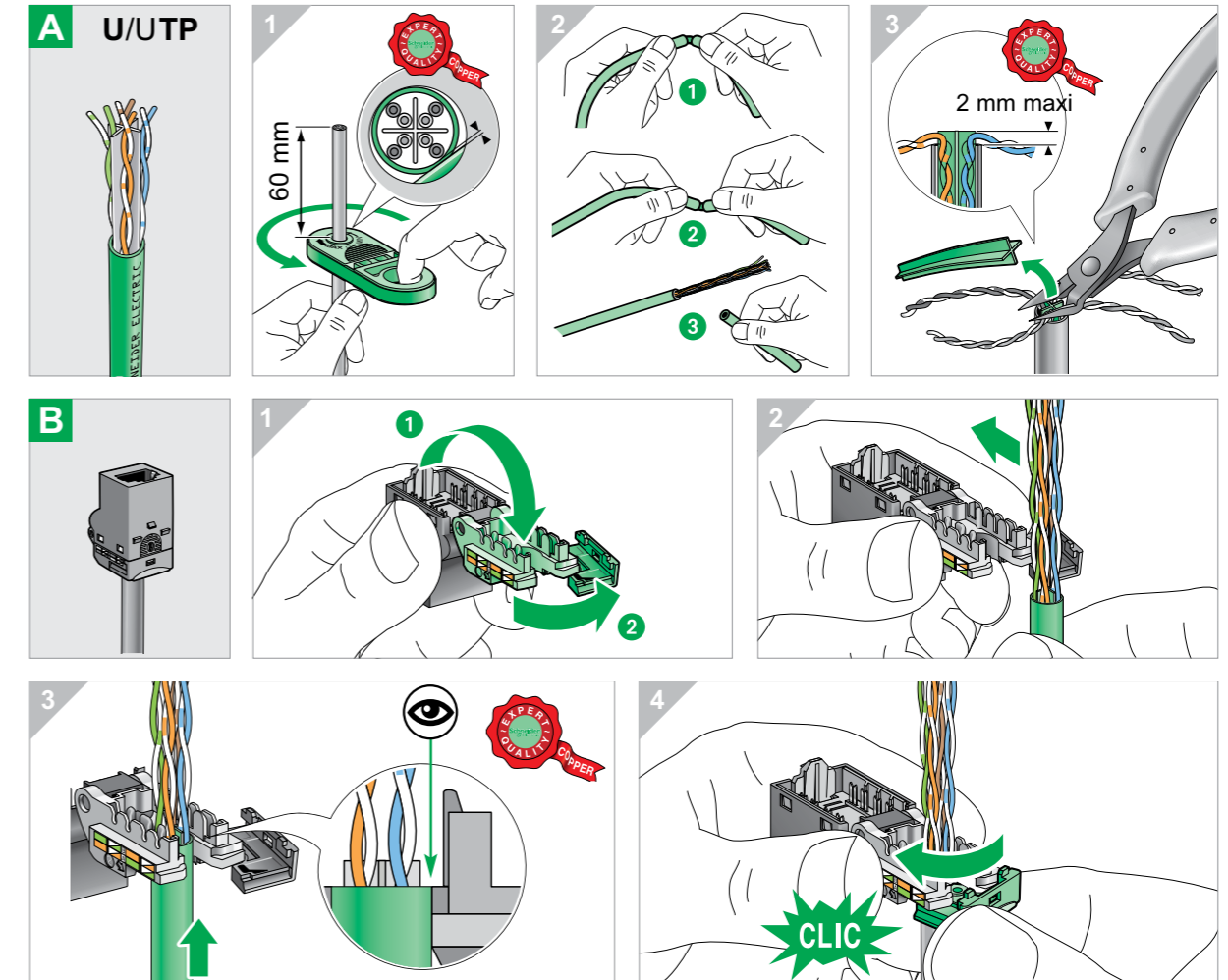

RJ45 data sockets (cont'd)

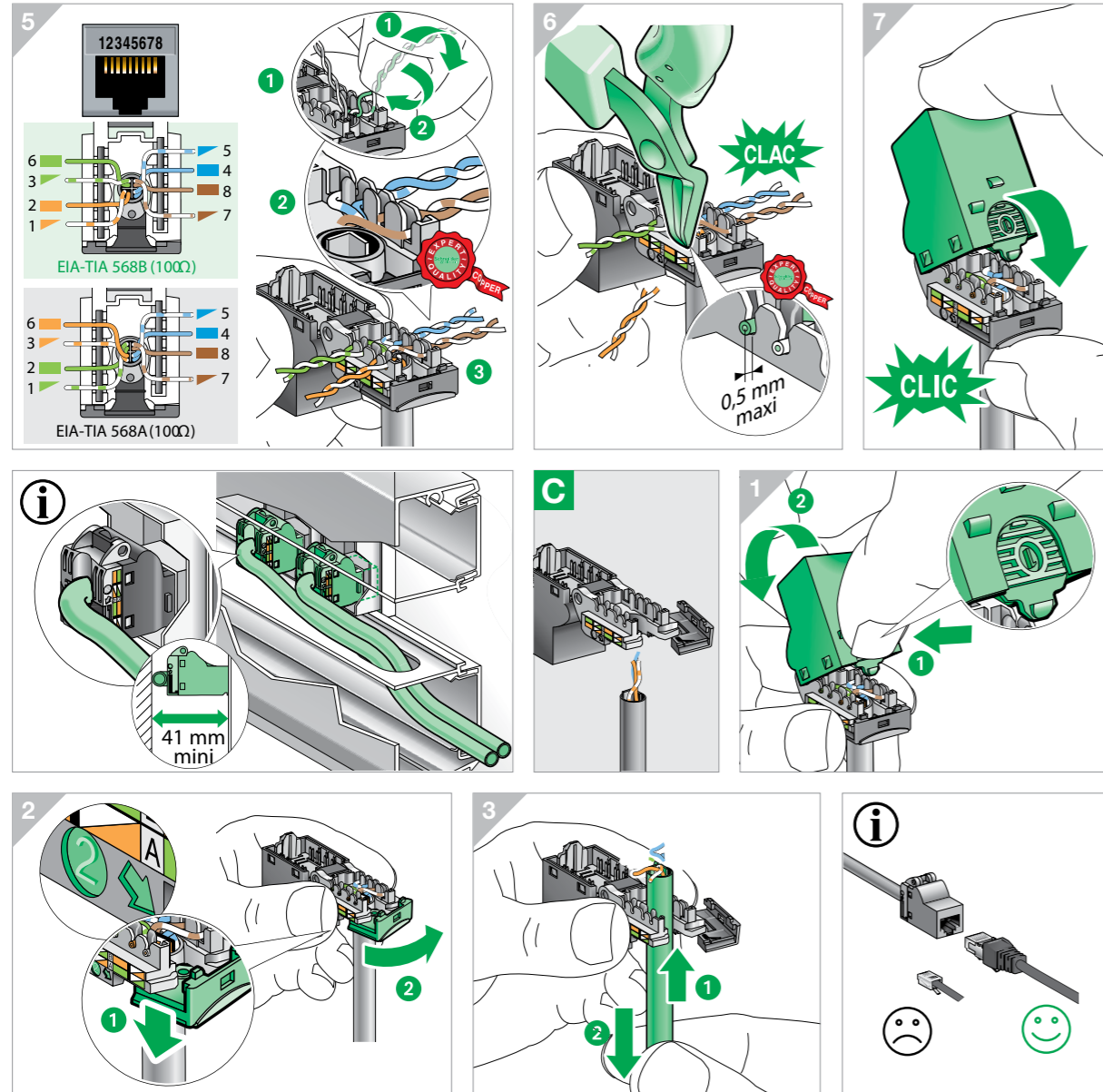

TV/R/SAT outlets

Area of application

Antenna sockets are adapted for connection of radio and television receivers, with land-based or satellite-based analog and digital signals.

Installation

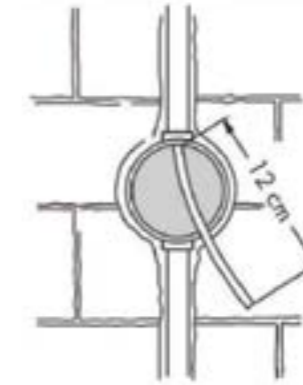

Dimensions (mm)

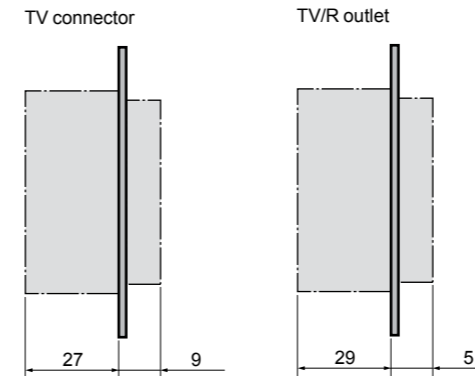

TV/SAT outlet
TV/R/SAT outlet
R-TV/SAT/SAT outlet

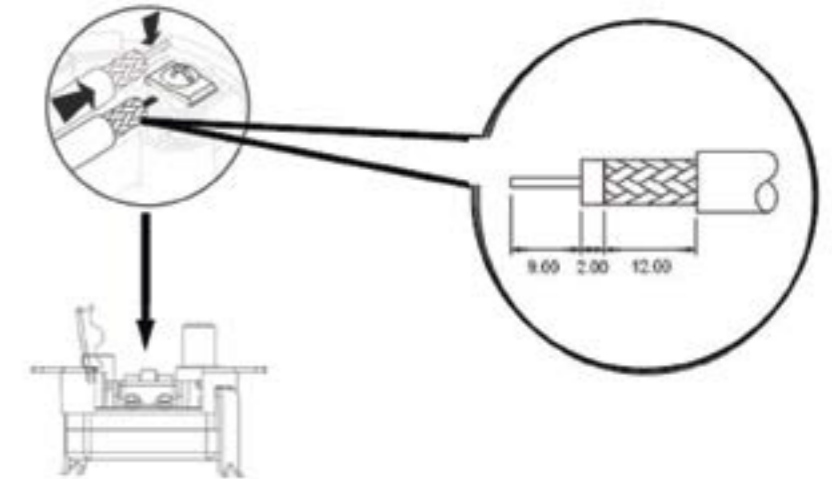
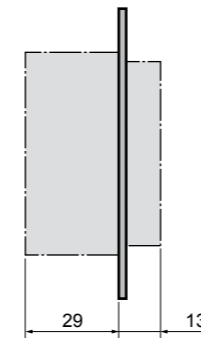

TV/R/SAT outlets

TV: individual / parallel installation insert

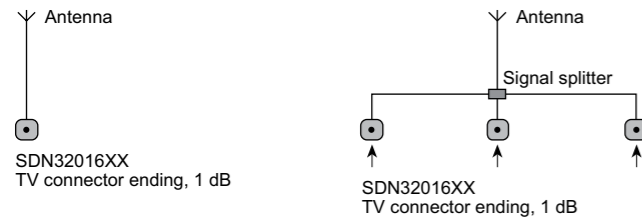

TV/R: individual / parallel installation insert

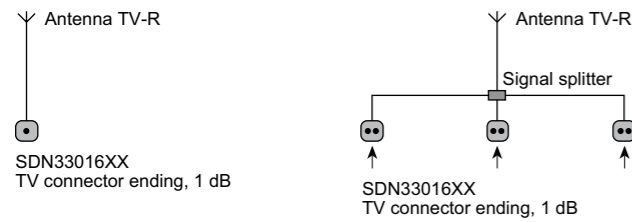

TV/R: linear installation insert

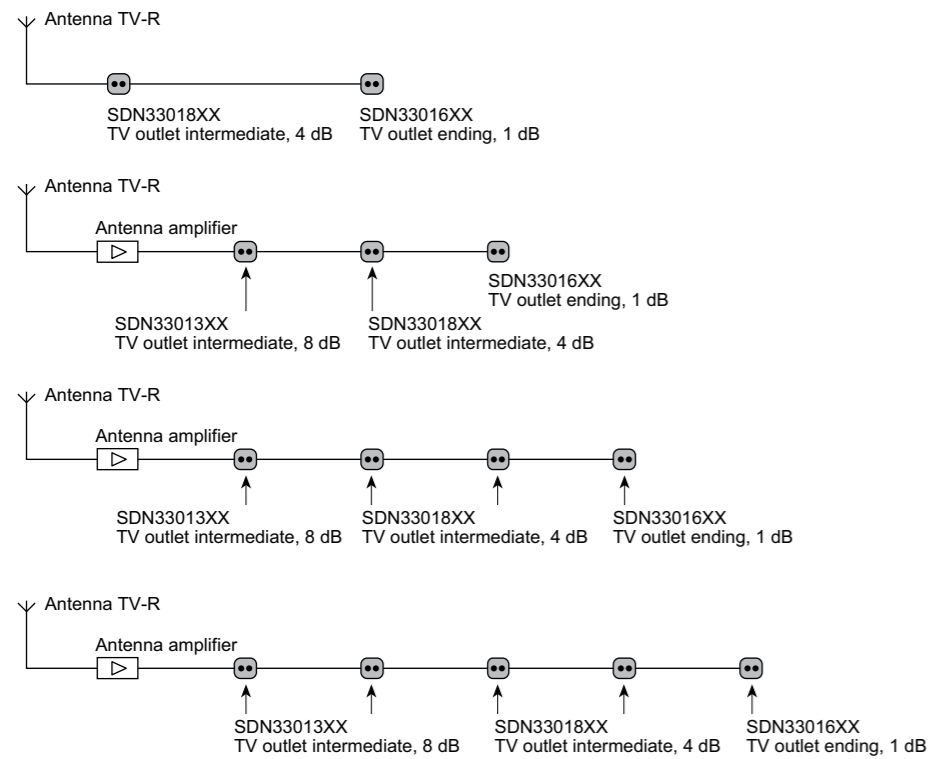

TV/SAT: individual / linear installation insert

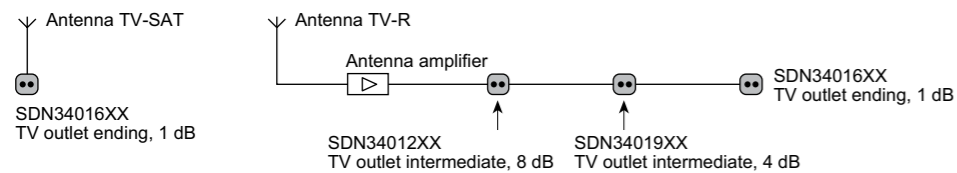

TV/R/SAT outlets

Connections

TV connector, intermediate TV connector, ending

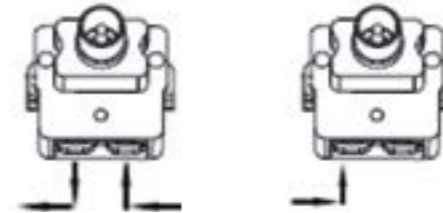

TV/R outlet, intermediate TV/R outlet, ending

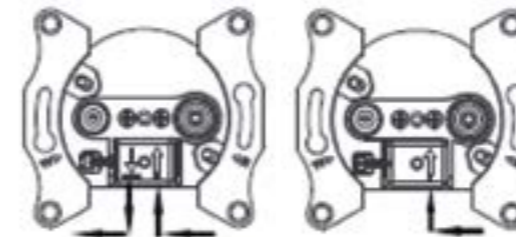

TV/SAT outlet, intermediate TV/SAT outlet, ending

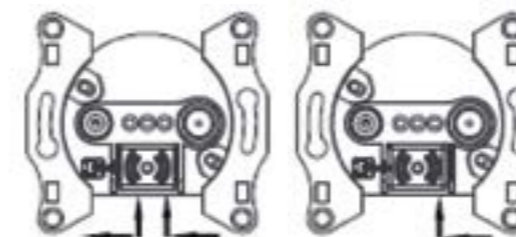

TV/R/SAT outlet, intermediate TV/R/SAT outlet, ending

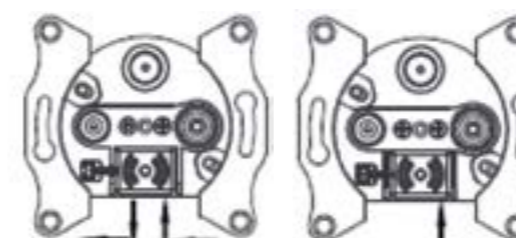

TV/SAT/SAT outlet, ending

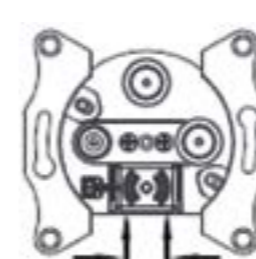

Technical data

TV connector

	SDN32018XX Intermediate	SDN32012XX Intermediate	SDN32016XX Ending
Loss (dB)	-	-	-
Operating frequency (MHz)	5-862	5-862	5-862
Output loss (dB)	4	8	1
Through loss (dB)	-	-	-

TV/R outlets

	SDN33018XX Intermediate	SDN33013XX Intermediate	SDN33016XX Ending
Loss (dB)	4	8	-
Operating frequency (MHz)	TV 5-862	5-862	5-862
Output loss (dB)	TV 4	88-125 8	1
Through loss (dB)	1	1	-

TV/SAT outlets

	SDN34019XX Intermediate	SDN34012XX Intermediate	SDN34016XX Ending
Loss (dB)	4	8	-
Operating frequency (MHz)	SAT 950-2400	950-2400	950-2400
Output loss (dB)	SAT 3	5-862 3	1
Through loss (dB)	1	8 1	-

TV/R/SAT outlets

	SDN35014XX Intermediate	SDN35012XX Intermediate	SDN35013XX Ending
Loss (dB)	4	8	-
Operating frequency (MHz)	SAT 950-2400	950-2400	950-2400
Output loss (dB)	TV 5-862	5-862	5-862
Through loss (dB)	1	88-125 1	-

TV/SAT/SAT outlets

	SDN35021XX Ending
Loss (dB)	-
Operating frequency (MHz)	SAT1 5-2400
Output loss (dB)	SAT2 950-2400
Through loss (dB)	TV 5-862

Horizontal surface mounting Boxes

Multi gang

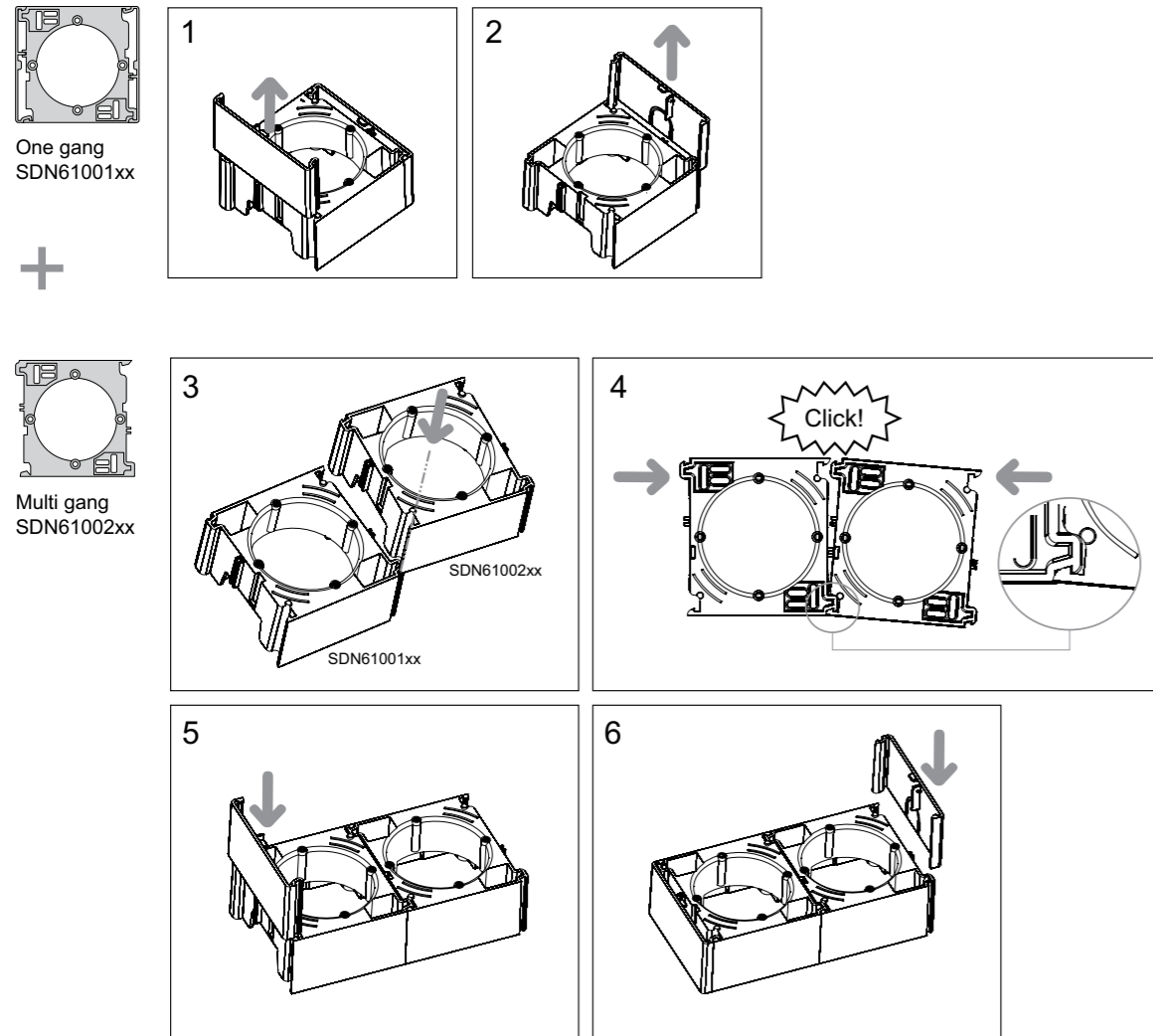

For TV/R, TV/SAT or TV/R/SAT outlets

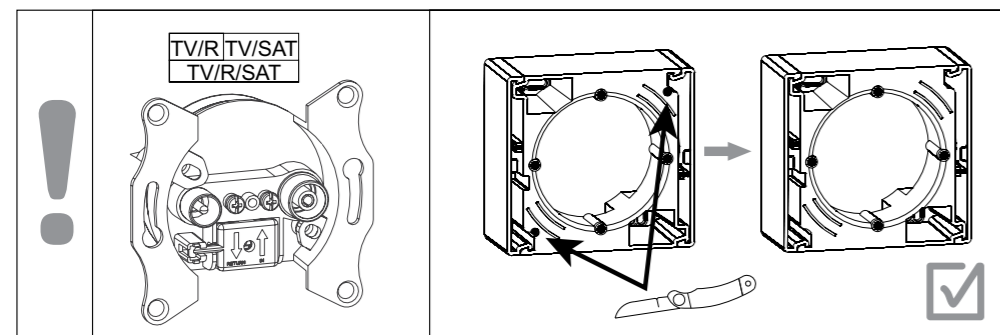

Cover frames dimensions (mm)

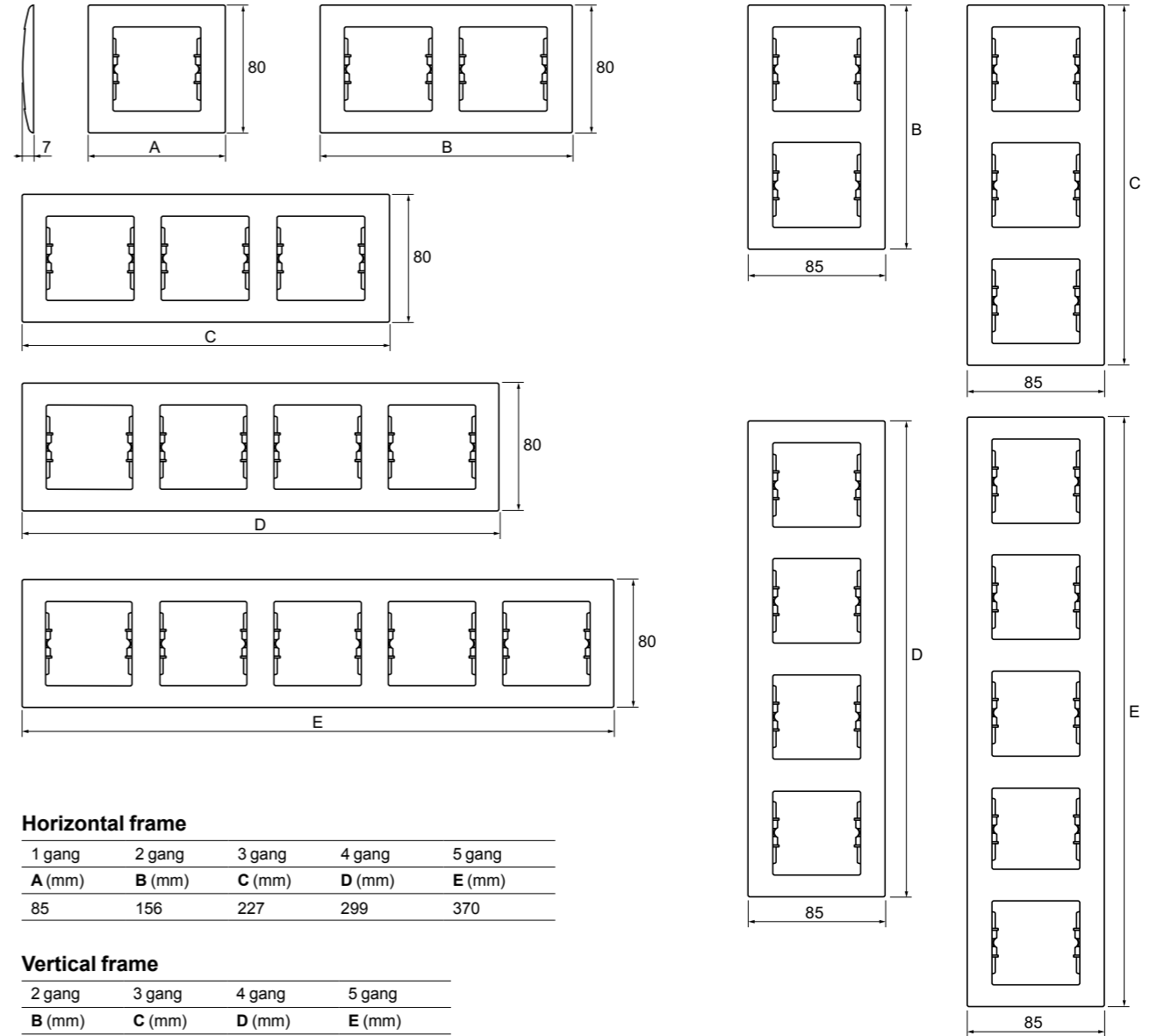

1 gang IP44 frame for IP44 switch or IP20 socket-outlet

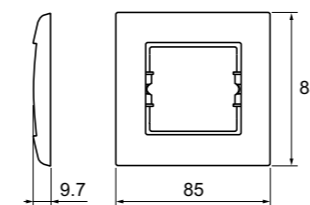

2 gang IP44 frame for IP44 switch or IP20 socket-outlet

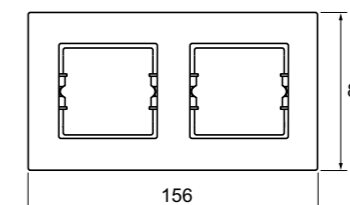

3 gang IP44 frame for IP44 switch or IP20 socket-outlet

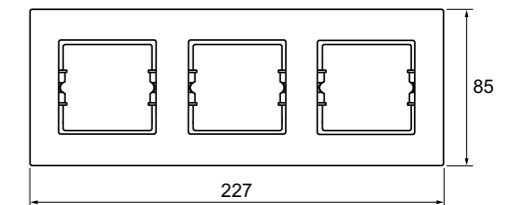

Reference number overview

Ref	Pages	Ref	Pages
SDN5800160	34	SDN5802023	34
SDN5800168	34	SDN5802033	34
SDN5800170	34	SDN5802041	34
SDN5800321	34	SDN5802047	34
SDN5800323	34	SDN5802060	34
SDN5800333	34	SDN5802068	34
SDN5800341	34	SDN5802070	34
SDN5800347	34	SDN5810521	34
SDN5800360	34	SDN5810523	34
SDN5800368	34	SDN5810547	34
SDN5800370	34	SDN5810560	34
SDN5800521	34	SDN5810568	34
SDN5800523	34	SDN5810570	34
SDN5800533	34	SDN5810621	34
SDN5800541	34	SDN5810623	34
SDN5800547	34	SDN5810647	34
SDN5800560	34	SDN5810660	34
SDN5800568	34	SDN5810668	34
SDN5800570	34	SDN5810670	34
SDN5800721	34	SDN5810721	34
SDN5800723	34	SDN5810723	34
SDN5800733	34	SDN5810747	34
SDN5800741	34	SDN5810760	34
SDN5800747	34	SDN5810768	34
SDN5800760	34	SDN5810770	34
SDN5800768	34	SDN5900123	31
SDN5800770	34	SDN6000121	25
SDN5800921	35	SDN6000123	25
SDN5800923	35	SDN6000147	25
SDN5800933	35	SDN6000160	25
SDN5800941	35	SDN6000168	25
SDN5800947	35	SDN6000170	25
SDN5800960	35	SDN6000321	25
SDN5800968	35	SDN6000323	25
SDN5800970	35	SDN6000347	25
SDN5801121	34	SDN6000360	25
SDN5801123	34	SDN6000368	25
SDN5801133	34	SDN6000370	25
SDN5801141	34	SDN6001121	25
SDN5801147	34	SDN6100121	33
SDN5801160	34	SDN6100123	33
SDN5801168	34	SDN6100147	33
SDN5801170	34	SDN6100160	33
SDN5801321	34	SDN6100168	33
SDN5801323	34	SDN6100170	33
SDN5801333	34	SDN6100221	33
SDN5801341	34	SDN6100223	33
SDN5801347	34	SDN6100247	33
SDN5801360	34	SDN6100260	33
SDN5801368	34	SDN6100268	33
SDN5801370	34	SDN6100270	33
SDN5801521	35		
SDN5801523	35		
SDN5801533	35		
SDN5801541	35		
SDN5801547	35		
SDN5801560	35		
SDN5801568	35		
SDN5801570	35		
SDN5802021	34		



<https://sid1.hu/>

Schneider Electric Industries SAS

35, rue Joseph Monier
CS 30323
92506 Rueil Malmaison Cedex
France

RCS Nanterre 954 503 439
Capital social 928 298 512 €
www.se.com

July, 2020
Sedna catalogue

© 2020- Schneider Electric. All Rights Reserved.
All trademarks are owned by Schneider Electric Industries SAS or its affiliated companies.
ISC01548EN

This document has been
printed on recycled paper

