

Variable speed drives Altivar 12

For 3-phase asynchronous motors
from 0.18 to 4 kW/0.25 to 5 HP

Catalog

January **2015**



How can you fit a 6000-page catalog in your pocket ?

Schneider Electric provides you with the complete set of industrial automation catalogs all on a handy USB key for PC or in an application for tablets



Digi-Cat, a handy USB key for PC



- > Convenient to carry
- > Always up-to-date
- > Environmentally friendly
- > Easy-to-share format

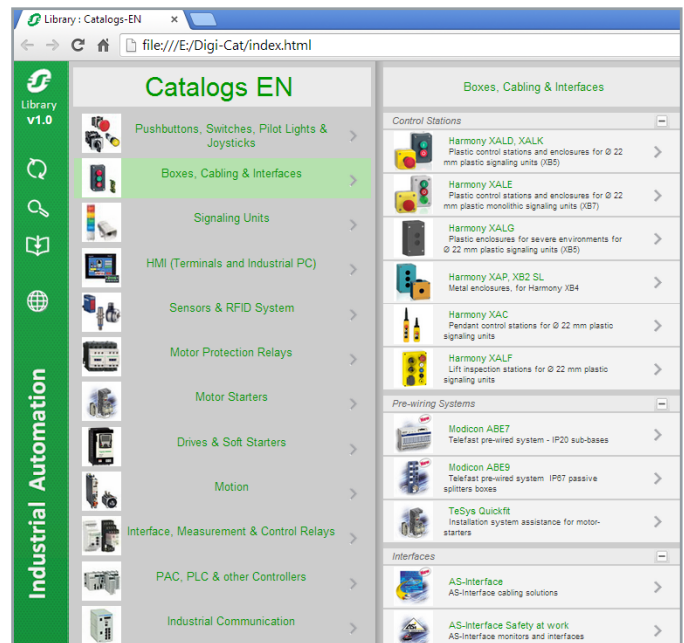

Contact your local representative to get your own Digi-Cat



e-Library, the app for tablets

If you have an iPad®:

- > Go to the App Store and search for e-Library
- > or scan the QR code



If you have an Android tablet:

- > Go to the Google Play Store™ and search for eLibrary
- > or scan the QR code

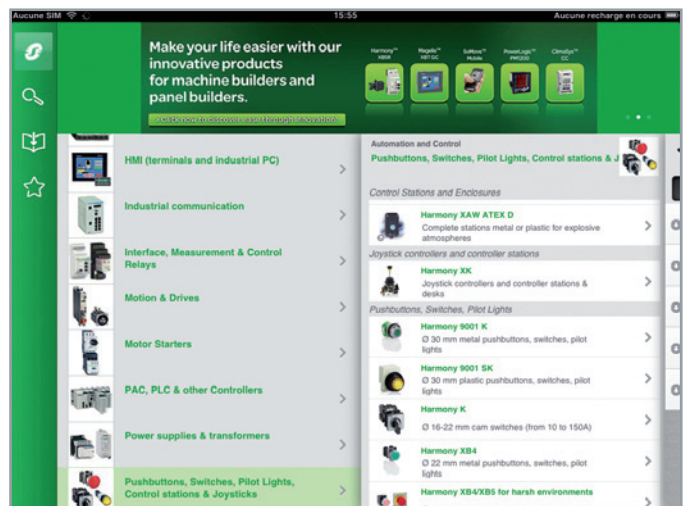

Variable speed drives Altivar 12

- **Brochure** page 2
- IP 20 or IP 21 variable speed drives for asynchronous and synchronous motors selection guide* page 6
- IP 54 or IP 55 variable speed drives for asynchronous and synchronous motors selection guide* page 8
- Variable speed drives Altivar 61 Plus and Altivar 71 Plus selection guide* page 10
- **Presentation of the Altivar 12 speed drives**
- Presentation page 12
- Applications page 12
- Functions page 13
- An optimized offer page 13
- Complementary characteristics page 14
- **References**
- Drives with heatsink page 16
- Drives on a base plate page 17
- Accessories page 18
- Configuration tools page 19
- Remote display terminals and associated cordsets page 20
- Additional EMC input filters page 20
- Motor chokes page 21
- Ferrite suppressors page 21
- Modbus serial links page 21
- Replacement parts page 21
- **Motor starters**
- Applications page 22
- Motor starters page 22
- Combinations page 23
- **Product reference index** page 24

Designing technology that frees you from technical tasks



With the Altivar 12, you get greater reliability and simplicity of operation and save even more time for all your applications.

- The smallest drive with integrated EMC for compact machines
- Ever more intuitive and user-friendly programming and menus
- Can be configured in complete safety with the power off, even in its packaging
- A design that can withstand even the harshest environments
- Quick and simple to set up
- With no compromise on quality, and components designed to last 10 years



Collaborative design

We surveyed our customers and users to determine their needs. The result is the innovative Altivar 12.

Make the most of your energy

Combining efficiency with intelligence

The Altivar 12 is particularly suitable for use in applications involving simple industrial machines or certain consumer machines. Its compact size, high performance and discreet appearance make it particularly attractive for use in the following sectors:

- The food industry (ventilation of catering kitchens, bagging machines, bakers' kneading machines, greenhouses, etc.)
- Small handling applications (car washes, conveyors, etc.)
- The medical and health sector (medical beds, fitness machines)
- Machines with a single-phase socket (wood-working machines, surface polishing and cleaning machines, swimming pool or irrigation pumps, hydromassage bathtubs, etc.)
- New markets (solar applications, etc.)
- Simple mechanical applications (2-speed motors, DC motors, mechanical drives, etc.)

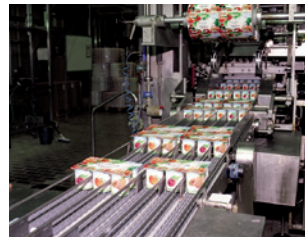

A design focussed on integration

- Upgrade your machines and make them more competitive: with its advanced functions (integrated PID, multi-speed) the Altivar 12 increases your productivity
- Communicate easily with all the other parts of your machine via the integrated universal Modbus serial link
- Reduce the depth of your equipment: the baseplate mounted version dissipates heat into the machine frame



Small

The small format and advanced functions of the Altivar 12 mean that it can easily replace any existing drive in its category.



Economical

- Design: Save time by using the SoMove software workshop
- Commissioning: Quicker configuration with the power off download function
- Wiring and mounting: Quicker and easier installation with integrated Modbus communication

Choose peace of mind

The Altivar 12 integrates as standard all the technologies that will make you forget it is there. Its design and choice of components make the Altivar 12 an extremely efficient, reliable and durable drive.

No compromise on quality

- Ever higher performance for your motors assured by:
 - The factory settings, which provide a high quality drive from the very first time the power is turned on
 - The integration of Standard (U/f), Performance (sensorless flux vector control, or SVC) and Pump/Fan (quadratic profile Kn^2) control profiles
 - High dynamic performance on acceleration as well as on braking
 - Excellent speed regulation on machine load surges
- Reduced noise and maintenance:
 - No fan on models up to 0.75 kW at 240 V
 - Cassette type fan, operates automatically on detection of specific temperature setting
- Designed for easy fitting and wiring of the drive:
 - A single tool
 - Power terminals not tightened, ready for wiring
 - Easy access angles
 - Numerous, easy to identify markings
- Fast detection and protection against the motor current peaks associated with certain applications (motor switching, catching on the fly, etc.)
- Perfect integration of single-phase 240 V model into the electrical network thanks to its built-in EMC filter



The fan, which is the only wearing part, can be changed without the need for any tool.



Practical, recyclable packaging. You can configure your product in its packaging without breaking the guarantee seal.



Sturdy

- New generation long-life components (10-year service life under normal operating conditions)
- Cards are coated as standard and resistance to disturbed power supplies has been increased to withstand harsh environments



Easy to identify

- All the identification markings on the product are on a hinged door on the front panel
- Easy identification of the connections



Ecological

- An average of 30% energy savings (with the Pump/Fan control profile) for the majority of applications
- Less cardboard to be recycled - only one box is used for bulk orders



Communicate intuitively with all your applications

The Altivar 12 is immediately operational. It is configured using the notched wheel or from the SoMove software workshop. The file that is generated can be downloaded to the product even while it is still in its packaging, using the Multi-Loader console. You save commissioning time so that you can spend more time doing your job.

Save time on commissioning

- The drive can be configured before it is received (by the distributor), during storage (by the storekeeper) or during fitting before the electrical enclosure is powered up for the first time
- No adjustment is required and there is a quick start guide for immediate setup
- Work in the language of your choice with the SoMove software workshop that can be downloaded free of charge from www.schneider-electric.com
- Select the functions you need from the menu
- Bluetooth option for PC for greater ease of use

Save time on wiring

- Easy access to all the wiring and adjustment functions on the front panel via a sealable hinged door
- Integrated EMC filter in 240 V single-phase versions
- No need to remove the terminal cover to wire the power section
- Only one screwdriver needed for wiring both the control and power sections
- Less wiring due to the integrated Modbus communication

Save time on programming

- A navigation button for easy menu access: you can set the parameters of your application with just a few clicks
- A three-level tree structure
 - Reference Mode: In local operation (On/Off buttons) and for speed adjustment and display
 - Monitoring Mode: For displaying parameters
 - Configuration Mode: For configuring your applications and settings



Use SoMove to customise your menus and save time during operation (possible for up to 25 parameters)



Fast

With the Multi-Loader console you can configure 10 drives in their packaging in less than 5 minutes, with no power supply!







Versatile

The Altivar 12 range is designed for 120 to 240 V power supplies. For your productivity requirements in the most varied applications, see the complete Altivar® range on our website: www.schneider-electric.com

IP 20 or IP 21 variable speed drives for asynchronous and synchronous motors

Type of machine	Simple machines	Pumps and fans (building (HVAC)) (1)	
			
Power range for 50...60 Hz (kW/HP) line supply	0.18...4/0.25...5	0.18...15/0.25...20	0.75...75/1...100
Single-phase 100...120 V (kW/HP)	0.18...0.75/0.25...1	–	–
Single-phase 200...240 V (kW/HP)	0.18...2.2/0.25...3	0.18...2.2/0.25...3	–
Three-phase 200...230 V (kW/HP)	–	–	–
Three-phase 200...240 V (kW/HP)	0.18...4/0.25...5	0.18...15/0.25...20	0.75...30/1...40
Three-phase 380...480 V (kW/HP)	–	–	0.75...75/1...100
Three-phase 380...500 V (kW/HP)	–	0.37...7.5/0.5...10	–
Three-phase 500...600 V (kW/HP)	–	–	–
Three-phase 525...600 V (kW/HP)	–	0.75...15/1...20	–
Three-phase 500...690 V (kW/HP)	–	–	–
Degree of protection	IP 20	IP 21	
Type of cooling (2)	Heatsink or base plate	Heatsink	
Drive	Output frequency	0.1...400 Hz	0.1...500 Hz
Type of control	Asynchronous motor	Standard (voltage/frequency) Performance (sensorless flux vector control) Pump/fan (Kn ² quadratic ratio)	Standard (voltage/frequency) Performance (sensorless flux vector control) Energy saving ratio
	Synchronous motor	–	Sensorless flux vector control Voltage/frequency ratio (2 points) Energy saving ratio
Transient overtorque	150...170% of the nominal motor torque	170...200% of the nominal motor torque	120% of the nominal motor torque
Functions			
Number of functions	40	50	50
Number of preset speeds	8	16	7
Number of I/O	Analog inputs	3	2
	Logic inputs	4	3
	Analog outputs	1	1
	Logic outputs	1	–
	Relay outputs	1	2
Communication	Integrated	Modbus	Modbus and CANopen
	Available as an option	–	Modbus, METASYS N2, APOGEE FLN, BACnet LonWorks
		CANopen Daisy Chain, DeviceNet, PROFIBUS DP, Modbus TCP, Fipio	
Cards (available as an option)	–	–	–
Dialogue tools	IP 54 or IP 65 remote terminal	IP 54 or IP 65 remote terminal IP 54 remote graphic display terminal	IP 54 or IP 65 remote graphic display terminal
Configuration tools	Setup software	SoMove	PCSoft for ATV 212
	Configuration tools	Simple Loader, Multi-Loader	Multi-Loader
Standards and certifications	IEC 61800-5-1 IEC 61800-3 (environments 1 and 2, categories C1 to C3, cat. C1 with option for ATV 212)	IEC 61800-5-1 IEC 61800-3 (environments 1 and 2, categories C1 to C3, cat. C1 with option for ATV 212)	EN 55011: Group 1, class A and class B with option card. CE, UL, CSA, C-Tick, NOM
	CE, UL, CSA, C-Tick, NOM, GOST	CE, UL, CSA, DNV, C-Tick, NOM, GOST	CE, UL, CSA, C-Tick, NOM
References	ATV 12	ATV 312	ATV 212
Catalogues	"Altivar 12 variable speed drives"	"Altivar 312 variable speed drives"	"Altivar 212 variable speed drives"

(1) Heating, Ventilation and Air Conditioning

Pumps and fans (industrial)	Complex machines
	  
0.37...800/0.5...900	0.37...630/0.5...700
–	–
0.37...5.5/0.5...7.5	0.37...5.5/0.5...7.5
–	–
0.75...90/1...125	0.37...75/0.5...100
0.75...630/1...900	0.75...500/1...700
–	–
2.2...7.5/3...10	1.5...7.5/2...10
–	–
2.2...800/3...800	1.5...630/2...700
IP 20	
Heatsink or water-cooled system	Heatsink, base plate or water-cooled system
0.1...500 Hz for the entire range 0.1...599 Hz up to 37 kW/50 HP at 200...240 V ~ and 380...480 V ~	0.1...500 Hz for the entire range 0.1...599 Hz up to 37 kW/50 HP at 200...240 V ~ and 380...480 V ~
Sensorless flux vector control Voltage/frequency ratio (2 or 5 points) Energy saving ratio	Flux vector control with or without sensor Voltage/frequency ratio (2 or 5 points) ENA System
Vector control without speed feedback 120% of the nominal motor torque for 60 seconds	Vector control with or without speed feedback 220% of the nominal motor torque for 2 seconds 170% for 60 seconds
> 100	> 150
8	16
2...4	2...4
6...20	6...20
1...3	1...3
0...8	0...8
2...4	2...4
Modbus and CANopen	Modbus TCP Daisy Chain, Modbus/Uni-Telway, EtherNet/IP (RSTP), DeviceNet, PROFIBUS DP V0 and V1, INTERBUS, CC-LINK, LonWorks, METASYS N2, APOGEE FLN, BACnet, Profinet, EtherCAT, POWERLINK
Modbus TCP Daisy Chain, Modbus/Uni-Telway, EtherNet/IP (RSTP), DeviceNet, PROFIBUS DP V0 and V1, INTERBUS, CC-LINK, LonWorks, METASYS N2, APOGEE FLN, BACnet, Profinet, EtherCAT, POWERLINK	Modbus TCP Daisy Chain, Modbus/Uni-Telway, EtherNet/IP (RSTP), DeviceNet, PROFIBUS DP V0 and V1, INTERBUS, CC-LINK, Profinet, EtherCAT, POWERLINK
I/O extension cards, "Controller Inside" programmable card, multi-pump cards, encoder interface cards	Interface cards for incremental, resolver, SinCos, SinCos Hiperface®, EnDat® or SSI encoders, I/O extension cards, Controller Inside programmable card
IP 54 or IP 65 remote graphic display terminal	
SoMove Simple Loader, Multi-Loader	
IEC 61800-5-1 IEC 61800-3 (environments 1 and 2, categories C1 to C3), IEC 61000-4-2/4-3/4-4/4-5/4-6/4-11	
CE, UL, CSA, DNV, C-Tick, NOM, GOST	
ATV 61	ATV 71
"Altivar 61 variable speed drives"	"Altivar 71 variable speed drives"

(2) The type of cooling depends on the model. Please consult pages 16 to 17.

IP 54 or IP 55 variable speed drives for asynchronous and synchronous motors

Type of machine	Simple machines	Pumps and fans (building (HVAC)) (1)
		
Power range for 50...60 Hz (kW/HP) line supply	0.18...15/0.25...20	0.75...75/1...100
Single-phase 200...240 V (kW/HP)	0.18...2.2/0.25...3	–
Three-phase 380...480 V (kW/HP)	–	0.75...75/1...100
Three-phase 380...500 V (kW/HP)	0.37...15/0.5...20	–
Degree of protection	IP 55	IP 55
Variants	Enclosure user-definable up to 4 kW/5 HP: Vario switch disconnecter, LEDs, selector switch, potentiometer	–
Drive		
Output frequency	0.1...500 Hz	0.1...200 Hz
Type of control	Asynchronous motor	Synchronous motor
Transient overtorque	170...200% of the nominal motor torque	120% of the nominal motor torque for 60 seconds
Functions		
Number of functions	50	50
Number of preset speeds	16	7
Number of I/O		
Analog inputs	3	2
Logic inputs	6	3
Analog outputs	1	1
Logic outputs	–	–
Relay outputs	2	2
Communication		
Integrated	Modbus and CANopen	Modbus, METASYS N2, APOGEE FLN, BACnet
Available as an option	Modbus TCP, Fipio, PROFIBUS DP, DeviceNet	LONWORKS
Cards (available as an option)	–	–
Dialogue tools	IP 65 remote terminal	IP 54 or IP 65 remote graphic display terminal
Configuration tools	SoMove Simple Loader	PCSoft for ATV 212 drive Multi-Loader
Standards and certifications	IEC 61800-5-1, IEC 61800-3 (environments 1 and 2, categories C1 to C3) CE, UL, CSA, C-Tick, GOST	
References	ATV 31C	ATV 212W
Catalogues	"Altivar 31C variable speed drives"	"Altivar 212 variable speed drives"

(1) Heating, Ventilation and Air Conditioning

Pumps and fans (industrial)	Complex machines			
				
0.75...90/1...125	0.75...75/1...100			
–	–			
0.75...90/1...125	0.75...75/1...100			
–	–			
IP 54				
–	Equipped with a Vario switch disconnecter			
	Equipped with a Vario switch disconnecter			
Drive				
Output frequency	0.1...599 Hz from 0.75 to 45 kW/1...60 HP 0.1...500 Hz from 55...90 kW/75...125 HP			
Type of control	Asynchronous motor			
Transient overtorque	110% of the nominal motor torque for 60 seconds			
Functions				
Number of functions	>100			
Number of preset speeds	8			
Number of I/O				
Analog inputs	2...4			
Logic inputs	6...20			
Analog outputs	1...3			
Logic outputs	0...8			
Relay outputs	2...4			
Communication				
Integrated	Modbus and CANopen			
Available as an option	Modbus TCP Daisy Chain, Modbus/Uni-Telway, EtherNet/IP (RSTP), DeviceNet, PROFIBUS DP V0 and V1, INTERBUS, CC-LINK, LONWORKS, METASYS N2, APOGEE FLN, BACnet, Profinet, EtherCAT, POWERLINK			
Cards (available as an option)	I/O extension cards, "Controller Inside" programmable card, multi-pump cards, encoder interface cards			
Dialogue tools	IP 54 or IP 65 remote graphic display terminal			
Configuration tools	SoMove Simple Loader, Multi-Loader			
Standards and certifications	IEC 61800-5-1, IEC 61800-3 (environments 1 and 2, categories C1 to C3), IEC 61000-4-2/4-3/4-4/4-5/4-6/4-11 CE, UL, CSA, DNV, C-Tick, NOM, GOST			
References	ATV 61W	ATV 61E5	ATV 71W	ATV 71E5
Catalogues	"Altivar 61 variable speed drives"		"Altivar 71 variable speed drives"	

Variable speed drives Altivar 61 Plus and Altivar 71 Plus Integrated solutions

Type of machine		Pumps and fans (industrial)		
				
Power range for 50...60 Hz (kW/HP) line supply		90...630/125...900	90...800/125...900	630...2400/800...2500
Three-phase 380...415 V (kW)		90...630	90...630	630...1400
Three-phase 480 V (HP)		125...900	125...900	900...2000
Three-phase 500 V (kW)		–	90...630	630...1800
Three-phase 600 V (HP)		–	125...800	800...2500
Three-phase 690 V (kW)		–	110...800	800...2400
Main characteristics		With enhanced protection		With enhanced protection and integrated cooling circuit
Variants		Ready to use	Standard offer Modular with integrated options User-definable on request	
Low Harmonic		–	Yes, only for ATV 61 Plus - LH	
Drive	Output frequency	0.1...500 Hz		
	Type of control	Sensorless flux vector control Voltage/frequency ratio 2 or 5 points Energy saving ratio		
		Flux vector control without speed feedback		
	Transient overtorque	120% of the nominal motor torque for 60 seconds		
Communication	Embedded	Modbus and CANopen		
	As an option	Modbus TCP, Modbus/Uni-Telway, EtherNet/IP, DeviceNet, PROFIBUS DP V0 and V1, InterBus, CC-LINK, LonWorks, METASYS N2, APOGEE FLN, BACnet		
Cards (available as an option)		"Controller Inside" programmable card Multi-pump cards		
Degree of protection		IP 54 with separate air flows, ATV61ES5	IP 23 compact version, ATV61EXC2 IP 54 compact version, ATV61EXC5 IP 54 with separate air flows, ATV61EXS5	With integrated air-cooled circuit: IP 23: ATV61EXA2 IP 54: ATV61EXA5 With external water-cooled system: IP 55, on request
Type of drive		ATV 61 Plus	ATV 61 Plus / ATV 61 Plus - LH	
Catalogues		"Altivar 61 and Altivar 61 Plus variable speed drives"		

Complex machines (industrial and infrastructure)				
				
Power range for 50...60 Hz (kW/HP) line supply		90...500/125...700	90...630/125...700	500...2000/550...2100
Three-phase 380...415 V (kW)		90...500	90...500	500...1300
Three-phase 480 V (HP)		125...700	125...700	550...1800
Three-phase 500 V (kW)		–	90...500	500...1500
Three-phase 600 V (HP)		–	125...700	700...2100
Three-phase 690 V (kW)		–	110...630	630...2000
Main characteristics		With enhanced protection		With enhanced protection and integrated cooling circuit
Variants		Ready to use	Standard offer Modular with integrated options User-definable on request	
Low Harmonic		–	Yes, for power regeneration to the mains supply, only for ATV 71 Plus - LH	
Drive	Output frequency	0.1...500 Hz		
	Type of control	Flux vector control with or without sensor Voltage/frequency ratio (2 or 5 points) ENA System		
		Vector control with or without speed feedback		
	Transient overtorque	220% of the nominal motor torque for 2 seconds 170% of the nominal motor torque for 60 seconds		
Communication	Embedded	Modbus and CANopen		
	As an option	Modbus TCP, Modbus/Uni-Telway, EtherNet/IP, DeviceNet, PROFIBUS DP V0 and V1, InterBus, CC-LINK		
Cards (available as an option)		"Controller Inside" programmable card		
Degree of protection		IP 54 with separate air flows, ATV71ES5	IP 23 compact version, ATV71EXC2 IP 54 compact version, ATV71EXC5 IP 54 with separate air flows, ATV71EXS5	IP 23, with integrated air-cooled circuit, ATV71EXA2 IP 54, with integrated air-cooled circuit, ATV71EXA5 IP 55, with external water-cooled system (on request)
Type of drive		ATV 71 Plus	ATV 71 Plus / ATV 71 Plus - LH	
Catalogues		"Altivar 71 and Altivar 71 Plus variable speed drives"		



ATV12 controlling an access barrier



ATV12 controlling a mixer

Presentation

The Altivar 12 drive is a frequency inverter for three-phase 200...240 V asynchronous motors rated from 0.18 kW/0.25 HP to 4 kW/5 HP.

The Altivar 12's ease of installation, based on the principle of Plug&Play, its compact size, its integrated functions and its alternative base plate version make it particularly suitable for applications involving simple industrial machines and certain consumer machines.

By taking account of the constraints governing installation and use at the product design stage, we have been able to offer a cost-effective solution to manufacturers of compact simple machines (OEMs) and installers.

Examples of solutions provided:

- Drive factory-configured for start-up without the need for any adjustment
- Multi-Loader configuration tool for loading a configuration onto the drive without taking it out of its packaging
- Labelled terminals to reduce wiring time; drive identification on the front panel
- Alternative delivery option of multiple units in a single special package (1). Like with the individually-shipped drives, it is possible to load a configuration into each drive without taking them out of the packaging.

Applications

Applications for simple industrial machines

- Handling (small conveyors, etc.)
- Packaging (small labelling machines, small bagging machines, etc.)
- Pumping applications (suction pumps, centrifugal pumps, circulating pumps, mono-pump and multi-pump stations, etc.)
- Machines equipped with a fan (air or smoke extraction, plastic film making machines, ovens, boilers, washing machines, etc.)

Applications for consumer machines

- Handling (access barriers, rotating advertising hoardings, etc.)
- Machines for health-related areas (medical beds, hydromassage equipment, running machines, etc.)
- Food and beverage industry machines (mills, kneading machines, mixers, etc.)

Other types of application

- Food and beverage industry (battery farming, greenhouses, etc.)
- Miscellaneous applications (mobile machines and small appliances equipped with a power socket, etc.)
- Applications which traditionally use other solutions:
 - 2-speed motor, DC motor, mechanical drive, etc.
 - Single-phase motor for pump and fan applications using mechanical control; the "Altivar 12 + three-phase motor" solution adapts the power to the requirements of the driving application, thus reducing energy consumption.

(1) Depending on the model (see page 16).



ATV12 controlling a pumping station

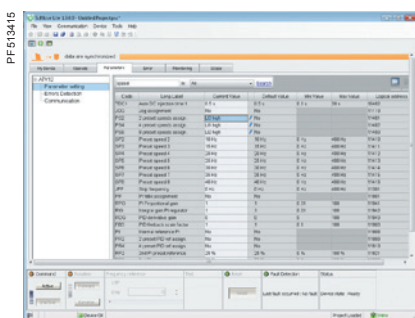

Preset speeds with SoMove



Drive with heatsink
ATV12H075M2



Drive on base plate
ATV12P075M2



ATV12H075M2 with door on front panel open

Functions

In addition to the functions usually available on this type of drive, the Altivar 12 drive also features the following:

Application functions (1)

- Switching between local control and control via the terminals
- Motor control profiles: standard, performance and pump/fan
- Frequency skip
- Preset speeds
- PID regulator
- S ramp, U ramp, ramp switching
- Freewheel stop, fast stop
- Jog operation
- Configuring the logic and analog I/O
- Underload and overload detection
- Viewing the state of the logic inputs on the drive display
- Configuring how the parameters are displayed
- Error log, etc.

Functions for pumping applications

- Sleep/wake-up
- PID functions
- Protection functions :
 - Protection against overloads and overcurrents in continuous operation (pump jamming)
 - Machine mechanical protection with control of operating direction
 - Protection of the installation by means of underload and overload detection

An optimized offer

The Altivar 12 range of variable speed drives extends across a range of motor power ratings from 0.18 kW/0.25 HP to 4 kW/5 HP on three types of power supply: Two standard versions are available:

- Drive with heatsink for normal environments and fan-cooled enclosure:
 - 100...120 V single-phase, 0.18 kW/0.25 HP to 0.75 kW/1 HP (**ATV12H●●●F1**)
 - 200...240 V single-phase, 0.18 kW/0.25 HP to 2.2 kW/3 HP (**ATV12H●●●M2**)
 - 200...240 V three-phase, 0.18 kW/0.25 HP to 4 kW/5 HP (**ATV12H●●●M3**)
- Drive on a base plate for mounting on the machine frame; the frame surface area should allow heat to dissipate:
 - 100...120 V single-phase, 0.18 kW/0.25 HP to 0.37 kW/0.5 HP (**ATV12H018F1, P037F1**)
 - 200...240 V single-phase, 0.18 kW/0.25 HP to 0.75 kW/1 HP (**ATV12H018M2, P●●●M2**)
 - 200...240 V three-phase, 0.18 kW/0.25 HP to 4 kW/5 HP (**ATV12H018M3, P●●●M3**)

Note: The Altivar 12 drive output voltage is 200...240 V three-phase, regardless of the type of drive line supply.

The Altivar 12 drive integrates as standard the Modbus communication protocol, which can be accessed via the RJ45 connector located on the underside of the drive 1 with a 2-wire RS 485 physical interface. To communicate on the network, the Altivar 12 speed drive uses the Modbus RTU transmission mode. For more information on the complementary characteristics of the Modbus port (transmission speed, address, messaging...), please consult our website www.schneider-electric.com.

The entire range conforms to international standards IEC/EN 61800-5-1 and IEC/EN 61800-3, is UL, CSA, C-Tick, NOM, GOST certified and has been developed to meet the requirements of directives regarding the protection of the environment (RoHS, WEEE) as well as those of European Directives to obtain the CE mark.

(1) For the implementation of functions please consult the user manual on our website www.schneider-electric.com.

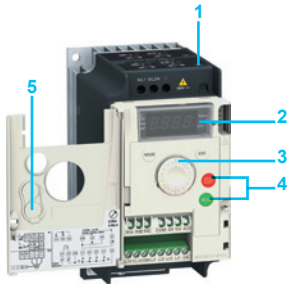

ATV12H075M2 with door on front panel open



Multi-Loader configuration tool



Remote terminal with cover closed



Remote terminal with cover open: RUN, FWD/REV and STOP buttons accessible

An optimized offer (continued)

Electromagnetic compatibility (EMC)

The integration of a level C1 EMC filter in ATV12●●●●M2 drives and the handling of EMC simplify installation and make it very inexpensive to bring the device into conformity to obtain the CE mark.

This EMC filter can be disconnected via an internal switch 1.

This filter is conform to the IEC61800-3 standard, environment 1, categories C1 and C2 depending on the model and on the motor cable length (see pages 16 and 17).

ATV12●●●●F1 and ATV12●●●●M3 drives are designed without an EMC filter. Filters are available as an option and can be installed by the customer to reduce the level of emissions (see page 18). The ATV12●●●●M2 speed drives can also have an additional filter (see page 19).

External accessories and options

External accessories and options can be used with Altivar 12 drives:

- EMC conformity kits, plates for direct mounting on 35 mm/1.38 in U rail, etc.
- Motor chokes, ferrite suppressors, additional EMC input filters, etc.

Dialogue and configuration tools

Human-Machine Interface (HMI)

The 4-digit display 2 can be used to display states and faults, access parameters and modify them via the navigation button 3.

The RUN and STOP buttons 4 can be made accessible on the front panel by removing the blanking plate 5 from the door; they must be configured in order to be active.

Simple Loader and Multi-Loader configuration tools

The Simple Loader tool enables one powered-up drive's configuration to be duplicated on another powered-up drive.

The Multi-Loader tool enables configurations from a PC or drive to be copied and duplicated on another drive; the drives do not need to be powered up.

SoMove setup software

The SoMove setup software can be used with the Altivar 12 drive for configuration, adjustment, debugging (using the Oscilloscope function) and maintenance, just as it can for all other Schneider Electric variable speed drives and starters. It can also be used to customize the integrated display terminal menus. It can be used with a direct connection or a Bluetooth® wireless connection.

Remote display terminal

The Altivar 12 drive can be connected to a remote display terminal, available as an option. This terminal can be mounted on an enclosure door with IP 54 or IP 65 degree of protection. The maximum operating temperature is 50°C. It provides access to the same functions as the Human-Machine interface.

Complementary characteristics

The following characteristics complement those introduced in the selection guide on pages 6 to 9.

Environmental conditions

- IEC 60721-3-3 classes 3C3 and 3S2

Ambient air temperature around the device in operation

- For ATV12H018F1, H037F1, H018M2...H075M2, H018M3...H075M3 and ATV12P●●●●● :

- From -10°C to +40°C without derating

- Up to +60°C, with the protective blanking cover removed and current derating of 2% per additional degree (1)

- For ATV12H075F1, 12HU15M2, HU22M2, 12HU15M3...HU40M3 :

- From -10°C to +50°C without derating

- Up to +60°C, with the protective blanking cover removed and current derating of 2% per additional degree (1)

(1) See the derating curves in the User Manual, available on our website at "www.schneider-electric.com".

Complementary characteristics (continued)

Analog input AI1

- Voltage analog input: 0...5 V $\overline{\text{---}}$ (internal power supply only) or 0...10 V $\overline{\text{---}}$, impedance 30 k Ω
 - Analog current input: X-Y mA by programming X and Y from 0...20 mA, impedance 250 Ω
- Sampling time: < 10 ms
 Resolution: 10 bits
 Accuracy: $\pm 1\%$ at 25°C
 Linearity: $\pm 0.3\%$ of the maximum scale value
 Factory setting: Input configured as voltage type

Analog output AO1

- 1 software-configurable voltage or current analog output:
- Analog voltage output: 0...10 V $\overline{\text{---}}$, minimum load impedance 470 Ω
 - Analog current output: 0 to 20 mA, maximum load impedance 800 Ω
- Update time: < 10 ms
 Resolution: 8 bits
 Accuracy: $\pm 1\%$ at 25°C

Relay outputs R1A, R1B, R1C

- 1 protected relay output, 1 N/O contact and 1 N/C contact with common point
 Response time: 30 ms maximum
 Minimum switching capacity: 5 mA for 24 V $\overline{\text{---}}$
 Maximum switching capacity:
- On resistive load ($\cos \varphi = 1$ and L/R = 0 ms): 3 A at 250 V \sim or 4 A at 30 V $\overline{\text{---}}$
 - On inductive load ($\cos \varphi = 0.4$ and L/R = 7 ms): 2 A at 250 V \sim or 30 V $\overline{\text{---}}$

Logic inputs LI1...LI4

- 4 programmable logic inputs, compatible with PLC level 1, standard IEC/EN 61131-2
 24 V $\overline{\text{---}}$ internal power supply or 24 V $\overline{\text{---}}$ external power supply (min. 18 V, max. 30 V)
 Sampling time: < 20 ms
 Sampling time tolerance: ± 1 ms
 Factory-set with 2-wire control in "transition" mode for machine safety reasons:
- LI1: forward
 - LI2...LI4: not assigned
- Multiple assignment makes it possible to configure several functions on one input (for example: LI1 assigned to forward and preset speed 2, LI3 assigned to reverse and preset speed 3)
 Impedance 3.5 k Ω

Logic outputs LO+, LO-

- One 24 V $\overline{\text{---}}$ logic output assignable as positive logic (Source) or negative logic (Sink) open collector type, compatible with level 1 PLC, standard IEC/EN 61131-2
 Maximum voltage: 30 V
 Linearity: $\pm 1\%$
 Maximum current: 10 mA (100 mA with external power supply)
 Impedance: 1 k Ω
 Update time: < 20 ms

Variable speed drives

Altivar 12

Drives with heatsink



ATV12H018M2



ATV12H075M2



ATV12HU40M3



ATV12HU15M2TQ (8)

Drives with heatsink										
Motor	Line supply			Altivar 12						
Power indicated on rating plate (1)	Max. line current (2)		Apparent power	Max. prospective line lsc	Maximum continuous output current (In) (1)	Maximum transient current for 60 s	Dissipated power at maximum output current (In) (1)	Reference	Weight (3)	
	at U1	at U2	at U2							at U2
kW	HP	A	A	kVA	kA	A	A	W	kg	
Single-phase supply voltage: 100...120 V 50/60 Hz (4)										
0.18	0.25	6	5	0.6	1	1.4	2.1	18	ATV12H018F1 (5)	0.700
0.37	0.5	11.4	9.3	1.1	1	2.4	3.6	29	ATV12H037F1	0.800
0.75	1	18.9	15.7	1.9	1	4.2	6.3	48	ATV12H075F1	1.300
Single-phase supply voltage: 200...240 V 50/60 Hz (4) (6)										
0.18	0.25	3.4	2.8	0.7	1	1.4	2.1	18	ATV12H018M2 (5) (7) (10)	0.700
0.37	0.55	5.9	4.9	1.2	1	2.4	3.6	27	ATV12H037M2 (7) (10)	0.700
0.55	0.75	8	6.7	1.6	1	3.5	5.3	34	ATV12H055M2 (7) (10)	0.800
0.75	1	10.2	8.5	2	1	4.2	6.3	44	ATV12H075M2 (7) (10)	0.800
1.5	2	17.8	14.9	3.6	1	7.5	11.2	72	ATV12HU15M2 (8) (9)	1.400
2.2	3	24	20.2	4.8	1	10	15	93	ATV12HU22M2 (8) (9)	1.400
Three-phase supply voltage: 200...240 V 50/60 Hz (4)										
0.18	0.25	2	1.7	0.7	5	1.4	2.1	16	ATV12H018M3 (5)	0.700
0.37	0.55	3.6	3	1.2	5	2.4	3.6	24	ATV12H037M3	0.800
0.75	1	6.3	5.3	2.2	5	4.2	6.3	41	ATV12H075M3	0.800
1.5	2	11.1	9.3	3.9	5	7.5	11.2	73	ATV12HU15M3	1.200
2.2	3	14.9	12.5	5	5	10	15	85	ATV12HU22M3	1.200
3	–	19	15.9	6.6	5	12.2	18.3	94	ATV12HU30M3	2.000
4	5	23.8	19.9	8.3	5	16.7	25	128	ATV12HU40M3	2.000
Dimensions (overall)										
Drives with heatsinks						W x H x D				
						EMC plate fixed			EMC plate not fixed	
						mm			mm	
ATV12H018F1, H018M2, H018M3						72 x 189.5 x 102.2			72 x 143 x 102.2	
ATV12H037F1, H037M2, H037M3						72 x 189.5 x 121.2			72 x 143 x 121.2	
ATV12H055M2, H075M2, H075M3						72 x 189.5 x 131.2			72 x 143 x 131.2	
ATV12H075F1, HU15M2, HU22M2						105 x 188.2 x 156.2			105 x 142 x 156.2	
ATV12HU15M3, HU22M3						105 x 189.3 x 131.2			105 x 143 x 131.2	
ATV12HU30M3, HU40M3						140 x 230.6 x 141.2			140 x 184 x 141.2	

(1) These values are given for a nominal switching frequency of 4 kHz, for use in continuous operation. If operation above 4 kHz needs to be continuous, the nominal drive current should be derated by 10% for 8 kHz, 20% for 12 kHz and 30% for 16 kHz.
The switching frequency can be set between 2 and 16 kHz for all ratings.
Above 4 kHz, the drive will reduce the switching frequency automatically in the event of an excessive temperature rise. See the derating curves in the User Manual, available on our website at "www.schneider-electric.com".

(2) Typical value for the indicated motor power and for the maximum prospective line lsc.

(3) Weight of product without packaging.

(4) Min. (U1) and max. (U2) nominal supply voltage: 100 (U1)...120 V (U2), 200 (U1)...240 V (U2).

(5) Due to the poor heat dissipation, the ATV12H018●● drive is only supplied as a base plate version.

(6) This drive is delivered with a disconnectable category C1 EMC filter. This drive complies with the IEC/EN 61800-3 standard, Environment 1 (public network), category C1, at 2, 4, 8, 12 and 16 kHz for a shielded motor cable length inferior or equal to 5 m.

(7) Complies with the IEC/EN 61800-3 standard, Environment 1 (public network), category C2, from 2 to 12 kHz for a shielded motor cable length inferior or equal to 5 m; and at 2, 4, 8, 12 and 16 kHz for a shielded motor cable length inferior or equal to 10 m.

(8) Complies with the IEC/EN 61800-3 standard, Environment 1 (public network), category C2, from 4 to 16 kHz for a shielded motor cable length inferior or equal to 5 m; and at 2, 4 and 16 kHz for a shielded motor cable length inferior or equal to 10 m.

(9) Available in lots of 7: add **TQ** at the end of the reference. ATV12HU22M2 becomes **ATV12HU22M2TQ**.

(10) Available in lots of 14: add **TQ** at the end of the reference. For example, ATV12H018M2 becomes **ATV12H018M2TQ**.

PF080623D



ATV12PU22M3

Drives on a base plate											
Motor Power indicated on rating plate (1)	Line supply				Altivar 12					Reference (3)	Weight (3)
	Max. line current (2)	Apparent power		Max. prospective line Isc	Maximum continuous output current (In) (1)	Maximum transient current for 60 s	Dissipated power at maximum output current (In) (1)	Reference			
		at U1	at U2					at U2	at U2		
kW	HP	A	A	kVA	kA	A	A	W		kg	
Single-phase supply voltage: 100...120 V 50/60 Hz (4)											
0.18	0.25	6	5	0.6	1	1.4	2.1	18		ATV12H018F1 (5)	0.700
–	–	11.4	9.3	1.1	1	2.4	3.6	29		ATV12P037F1 (6)	0.700
Single-phase supply voltage: 200...240 V 50/60 Hz (4) (7)											
0.18	0.25	3.4	2.8	0.7	1	1.4	2.1	18		ATV12H018M2 (5) (8)	0.700
–	–	5.9	4.9	1.2	1	2.4	3.6	27		ATV12P037M2 (6)	0.700
–	–	8	6.7	1.6	1	3.5	5.3	34		ATV12P055M2 (6)	0.700
–	–	10.2	8.5	2	1	4.2	6.3	44		ATV12P075M2 (6)	0.700
Three-phase supply voltage: 200...240 V 50/60 Hz (4)											
0.18	0.25	2	1.7	0.7	5	1.4	2.1	16		ATV12H018M3 (5)	0.700
–	–	3.6	3	1.2	5	2.4	3.6	24		ATV12P037M3 (6)	0.700
–	–	6.3	5.3	2.2	5	4.2	6.3	41		ATV12P075M3 (6)	0.700
–	–	11.1	9.3	3.9	5	7.5	11.2	73		ATV12PU15M3 (6)	1.000
–	–	14.9	12.5	5	5	10	15	85		ATV12PU22M3 (6)	1.000
–	–	19	15.9	6.6	5	12.2	18.3	94		ATV12PU30M3 (6)	1.600
–	–	23.8	19.9	8.3	5	16.7	25	128		ATV12PU40M3 (6)	1.600
Dimensions (overall)											
Drives on a base plate						W x H x D					
						EMC plate fixed			EMC plate not fixed		
						mm			mm		
ATV12P037F1, ATV12P037M2...P075M2						72 x 189.5 x 102.2			72 x 143 x 102.2		
ATV12P037M3...P075M3											
ATV12PU15M3, PU22M3						105 x 189.3 x 98.2			105 x 143 x 98.2		
ATV12PU30M3, PU40M3						140 x 230.6 x 100.2			140 x 184 x 100.2		

(1) These values are given for a nominal switching frequency of 4 kHz, for use in continuous operation.

If operation above 4 kHz needs to be continuous, the nominal drive current should be derated by 10% for 8 kHz, 20% for 12 kHz and 30% for 16 kHz.

The switching frequency can be set between 2 and 16 kHz for all ratings.

Above 4 kHz, the drive will reduce the switching frequency automatically in the event of an excessive temperature rise.

See the derating curves in the User Manual, available on our website at «www.schneider-electric.com».

(2) Typical value for the indicated motor power and for the maximum prospective line Isc.

(3) Weight of product without packaging.

(4) Min. (U1) and max. (U2) nominal supply voltage: 100 (U1)...120 V (U2). 200 (U1)...240 V (U2).

(5) Due to the poor heat dissipation the ATV12H018M2 drive is only supplied as a base plate version.

(6) To size the ATV12P drive correctly see the specific manual for the Altivar 12 base plate version available on our website at «www.schneider-electric.com».

(7) This drive is delivered with a disconnectable category C1 EMC filter. This drive complies with the IEC/EN 61800-3 standard, Environment 1 (public network), category C1, at 2, 4, 8, 12 and 16 kHz for a shielded motor cable length inferior or equal to 5 m; and category C2, from 2 to 12 kHz for a shielded motor cable length inferior or equal to 5 m and at 2, 4 and 16 kHz for a shielded motor cable length inferior or equal to 10 m.

(8) Available in lots of 14: add **TQ** at the end of the reference. For example. ATV12H018M2 becomes **ATV12H018M2TQ**.



VW3A9804

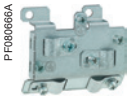

VW3A9523



VW3A9524

Accessories

Description	For drives	Reference	Weight kg
Fixing plates for fixing on 35 mm wide U rail	ATV12H018F1, H037F1 ATV12H018M2...H075M2 ATV12H018M3...H075M3	VW3A9804	0.290
	ATV12H075F1 ATV12HU15M2, HU22M2 ATV12HU15M3, HU22M3	VW3A9805	0.385
EMC conformity kits These provide a connection compliant with EMC standards (for further information, please consult our website www.schneider-electric.com .) The kit consists of: <ul style="list-style-type: none"> ■ The EMC plate ■ Clamps ■ Fixing accessories 	ATV12H018F1, H037F1 ATV12H018M2...H075M2 ATV12H018M3...H075M3 ATV12P037F1 ATV12P037M2...P075M2 ATV12P037M3...P075M3	VW3A9523	0.170
	ATV12H075F1 ATV12HU15M2, HU22M2 ATV12HU15M3, HU22M3 ATV12PU15M3, PU22M3	VW3A9524	0.190
	ATV12HU30M3, HU40M3 ATV12PU30M3, PU40M3	VW3A9525	0.210
+15 V/+24 V voltage converter Connects directly to the control terminals	ATV12●●●●●●	VW3A9317	—

Dimensions (overall)

Accessories	W x H x D mm
Fixing plates for fixing on an AM1 ED 35 mm U rail	
VW3A9804	77.5 x 143.6 x 37.9
VW3A9805	105 x 144 x 40



TCSWAAC13FB

Configuration tools

Description	For drives	Reference	Weight kg
SoMove lite setup software and associated accessories			
SoMove lite setup software For configuring, adjusting and debugging the Altivar 12 drive. Downloadable from our website "www.schneider-electric.com" or available on the "Description of the Motion & Drives Offer" DVD ROM VW3A8200.	ATV12●●●●●●	(1)	—
USB/RJ45 cable equipped with a USB connector and an RJ45 connector. For connecting a PC to the Altivar 12 drive. Length: 2.5 m	ATV12●●●●●●	TCSMCNAM3M002P	—
Modbus/Uni-Telway-Bluetooth® adaptor For establishing a Bluetooth® wireless connection between the Altivar 12 drive and a PC equipped with a Bluetooth® wireless link. Pack contents: <ul style="list-style-type: none"> ■ 1 Bluetooth® adaptor (range 20 m, class 2) with an RJ45 connector ■ For SoMove : 1 x 0.1 m cordset with 2 RJ 45 connectors (2) ■ For TwidoSuite : 1 x 0.1 m cordset with 1 RJ 45 connector and 1 connector of mini DIN type 	ATV12●●●●●●	TCSWAAC13FB	0.032
USB - Bluetooth® adaptor for PC Required for a PC which is not equipped with Bluetooth® technology. Connects to a USB port on the PC. Range of 10 m (class 2).	—	VW3A8115	0.200
Simple Loader, Multi-Loader configuration tools and associated cable			
Simple Loader tool For duplicating one drive configuration on another drive. The drives must be powered-up. The tool is supplied with a cordset equipped with 2 RJ45 connectors.	ATV12●●●●●●	VW3A8120	—
Multi-Loader tool 1 For copying a configuration on a PC or drive and duplicating it on another drive. The drives do not need to be powered-up. Supplied with the tool: <ul style="list-style-type: none"> ■ 1 cordset equipped with 2 RJ45 connectors ■ 1 cordset equipped with a USB type A connector and a USB Mini-B type connector ■ 1 x 2 GB SD memory card ■ 1 female/female RJ45 adaptor ■ 4 AA/LR6 1.5 V batteries 	ATV12●●●●●●	VW3A8121	—
Cordset for Multi-Loader tool 2 For connecting the Multi-Loader tool to the Altivar 12 drive in its packaging. Equipped with a non-locking RJ45 connector with special mechanical catch on the drive end and an RJ45 connector on the Multi-Loader end.	ATV12●●●●●● in its packaging	VW3A8126	—
SoMove Mobile software for mobile phone SoMove Mobile software allows you to edit drive parameters from a mobile phone using a Bluetooth® wireless connection. Requires the Modbus - Bluetooth® adaptor VW3A8114 (see page 17). It can also be used to back up configurations, which can be imported or exported from a PC. SoMove Mobile software can be downloaded from our website "www.schneider-electric.com".	ATV12●●●●●●	(1) (3)	—

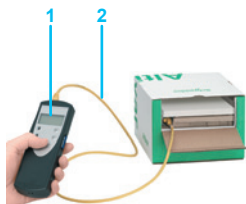

Configuring the drive in its packaging with the Multi-Loader tool VW3A8121+ cordset VW3A8126

(1) Available on our website www.schneider-electric.com.

(2) Also includes other components for connecting compatible Schneider Electric devices.

(3) The SoMove Mobile software requires a basic mobile phone; please consult our website "www.schneider-electric.com".



VW3A1006 with cover open: RUN, FWD/REV and STOP buttons accessible

Remote display terminals and associated cordsets

Remote display terminals For fixing the Human-Machine interface on an enclosure door with IP 54 or IP 65 degree of protection. A remote-fixing cordset VW3A1104R●● is also required.	IP 54 degree of protection	ATV12●●●●●●	VW3A1006	0.250
	IP 65 degree of protection	ATV12●●●●●●	VW3A1007	0.275
Remote-fixing cordsets equipped with 2 RJ45 connectors. For connecting the VW3A1006 or VW3A1007 remote display terminal to the Altivar 12 drive.	Length: 1 m	ATV12●●●●●●	VW3A1104R10	0.050
	Length: 3 m	ATV12●●●●●●	VW3A1104R30	0.150

Dimensions (overall)

Remote display terminal	W x H x D mm
VW3A1006	50 x 70 x 22.7

Additional EMC input filters

For compliance with the requirements of standard IEC/EN 61800-3, category C1, C2 or C3, in Environment 1 (public network) or Environment 2 (industrial network), depending on the drive rating.



VW3A4416

For drives Reference	Additional EMC input filter			Reference	Weight kg
	Shielded cable maximum length (1)				
	IEC 61800-3 (2)				
	Category C1 from 4 to 12 kHz	Category C2 from 4 to 12 kHz	Category C3 from 4 to 12 kHz		
	m	m	m		kg
ATV12H018F1...H037F1 ATV12P037F1	5	20	20	VW3A4416	1.120
ATV12H018M2...H075M2 ATV12P037M2...P075M2	20	50	50		
ATV12H075F1	5	20	20	VW3A4417	1.455
ATV12HU15M2, HU22M2 ATV12PU15M3, PU22M3	20	50	50		
ATV12H018M3...H075M3 ATV12P037M3... P075M3	–	20	20	VW3A4418	1.210
ATV12HU15M3, HU22M3 ATV12PU15M3, PU22M3	5	20	20	VW3A4419	1.440

Dimensions (overall)

Additional EMC input filters	W x H x D mm
VW3A4416	75 x 194 x 30
VW3A4417	117 x 184 x 40
VW3A4418	75 x 194 x 40
VW3A4419	117 x 190 x 40



ATV12H075M2 with EMC kit VW3A9523 fixed on EMC filter VW3A4416

(1) The filter choice table gives the maximum lengths of the shielded cables between the motors and the drives. These maximum lengths are given for indication because they depend on the motor properties and on the used cables. In the case of parallel motors, the total addition of the lengths must be taken into account.

(2) IEC 61800-3 standard : EMC immunity and EMC conducted and radiated emissions :

- categories C1 et C2 : public network

- category C3 : industrial network

For further information, see the "Conducted EMC emissions" and "Radiated EMC emissions" characteristics on our website www.schneider-electric.com.

Variable speed drives

Altivar 12

Motor chokes, ferrite suppressors, Modbus serial links, and replacement parts

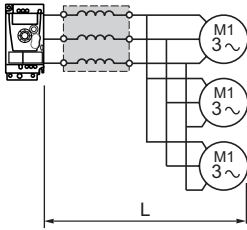

ATV12VW3A455
Motor choke

Motor chokes

Description	Nominal current A	For drives	Reference	Weight kg
Motor chokes Required: ■ When connecting more than 2 motors in parallel ■ When the motor cable length (L), including tap-offs, is: □ 50...100 m for a shielded motor cable (1), □ 100...200 m for an unshielded motor cable (1).	4	ATV12H018F1, H037F1 ATV12H018M2...H055M2 ATV12H018M3, H037M3 ATV12P037F1 ATV12P037M2, P055M2 ATV12P037M3	VW3A4551	1.880
	10	ATV12H075F1 ATV12H075M2, HU15M2 ATV12H075M3, HU15M3 ATV12P075M2 ATV12P075M3, PU15M3	VW3A4552	3.700
	16	ATV12HU22M2 ATV12HU22M3, HU30M3 ATV12PU22M3, PU30M3	VW3A4553	4.100
	30	ATV12HU40M3 ATV12PU40M3	VW3A4554	6.150

Dimensions (overall)

Motor chokes	W x H x D mm
VW3A4551	100 x 135 x 60
VW3A4552, A4553	130 x 155 x 90
VW3A4554	155 x 170 x 135

Ferrite suppressors for downstream contactor opening

Description	For drives	Sold in lots of	Unit reference	Weight kg
Ferrite suppressors 2 for downstream contactor opening 3 and for use with ATV12HU...M2 or ATV12HU...M3 drives 1	ATV12H018M2	3	VW3A31451	0.300
	ATV12H037M2, ATV12H018M3, H037M3	3	VW3A31452	0.200
	ATV12H055M2...HU22M2, ATV12H075M3...HU22M3	3	VW3A31453	0.100

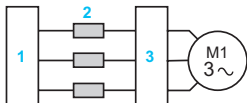

Ferrite suppressors

Dimensions (overall)

Ferrite suppressors	W x H x D mm
VW3A31451	33 x 33 x 33.5
VW3A31452	22.5 x 21.5 x 33
VW3A31453	19 x 19 x 30

Modbus serial link

Description	Item no.	Length m	Unit reference	Weight kg	
Connection via splitter box and RJ45 connectors					
Modbus splitter box 10 RJ45 connectors and 1 screw terminal	1	–	LU9GC3	0.500	
Cordsets for Modbus serial link equipped with 2 RJ45 connectors	2	0.3	VW3A8306R03	0.025	
		1	VW3A8306R10	0.060	
		3	VW3A8306R30	0.130	
Modbus T-junction boxes (with integrated cable)	3	0.3	VW3A8306TF03	0.190	
		1	VW3A8306TF10	0.210	
Line terminators (4) (5) For RJ45 connector	R = 120 Ω C = 1 nf	4	–	VW3A8306RC	0.010
	R = 150 Ω	4	–	VW3A8306R	0.010

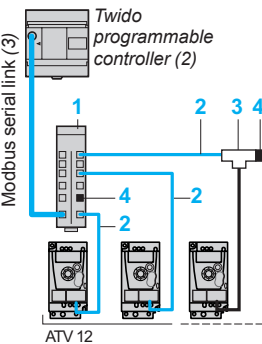

Example of Modbus diagram with connection via splitter box and RJ45 connectors

Replacement parts

Description	For drives	Reference	Weight kg
Fans	ATV12H075F1, ATV12HU15M2, ATV12HU22M2	VZ3V1301	0.160
	ATV12HU15M3...HU40M3	VZ3V1302	0.150

(1) Motor cable length given for a switching frequency of 4 kHz.
 (2) Please refer to the Twido programmable controller catalogue.
 (3) Cable depends on the type of controller or PLC.
 (4) Order in multiples of 2.
 (5) Depends on the bus architecture.

PF08047A



VZ3V1302

Variable speed drives

Altivar 12

Motor starters: Single-phase supply voltages
100...120 V and 200...240 V

Applications

The proposed combinations can:

- Protect people and equipment (when a short-circuit occurs)
- Maintain protection upstream of the drive in the event of a short-circuit on the power stage

Two types of combination are possible:

- Drive + circuit-breaker: Minimum combination
- Drive + circuit-breaker + contactor: Minimum combination with contactor when a control circuit is needed

Motor starters

Standard power ratings of three-phase 4-pole 50/60 Hz motors (2)	Variable speed drive		Combination with control circuit (circuit-breaker + contactor)			TeSys contactor (1)
	Minimum combination (circuit-breaker only)	Operating range or rating	Maximum short-circuit current I _{cu}			
kW HP	A	A	kA			KM1
Single-phase supply voltage: 100...120 V 50/60 Hz (5)						
0.18 0.25	ATV12H018F1	GV2ME14	6...10	> 100		LC1K09
		GV2L10	6.3	> 100		
		2-pole C60N	10	10		
0.37 0.5	ATV12●037F1	GV2ME16	9...14	> 100		LC1K12
		GV2L16	14	> 100		
		2-pole C60N	16	10		
0.75 1	ATV12H075F1	GV2ME21	17...23	50		LC1D25
		GV2L22	25	> 50		
		2-pole C60N	20	10		
Single-phase supply voltage: 200...240 V 50/60 Hz (5)						
0.18 0.25	ATV12H018M2	GV2ME08	2.5...4	> 100		LC1K09
		GV2L08	4	> 100		
		2-pole C60N	6	10		
0.37 0.55	ATV12●037M2	GV2ME14	6...10	> 100		LC1K09
		GV2L10	6.3	> 100		
		2-pole C60N	10	10		
0.55 0.75	ATV12●055M2	GV2ME14	6...10	> 100		LC1K09
		GV2L14	10	> 100		
		2-pole C60N	10	10		
0.75 1	ATV12●075M2	GV2ME16	9...14	> 100		LC1K12
		GV2L16	14	> 100		
		2-pole C60N	16	10		
1.5 2	ATV12HU15M2	GV2ME21	17...23	50		LC1D18
		GV2L20	18	> 100		
		2-pole C60N	20	10		
2.2 3	ATV12HU22M2	GV2ME32	24...32	50		LC1D25
		GV2L22	25	50		
		2-pole C60N	32	10		

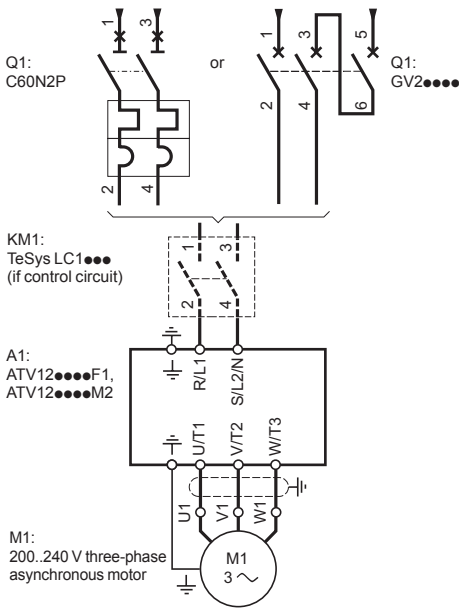

Motor starter with single-phase power supply

(1) For a complete list of references for TeSys contactors, please refer to the "Motor starter solutions - Control and protection components" and "Motor starters up to 150 A" catalogues or visit "www.schneider-electric.com".
 (2) Motor power indicated for combination with an ATV12H●●●●● drive with the same rating. For combination with an ATV12P●●●●● drive, refer to the specific manual for the Altivar 12 base plate version, available on our website at "www.schneider-electric.com".
 (3) TeSys motor circuit-breakers:
 - GV2 ME●●: Thermal magnetic motor circuit-breakers with pushbutton control
 - GV2 L●●: Magnetic motor circuit-breakers with control by rotary knob
 (4) 2-pole C60N modular circuit-breaker
 (5) Can be integrated in devices connected to a power socket:
 - If the line current is ≤ 16 A, connection to a single-phase power socket, 10/16 A 250 V ~
 - If the line current is > 16 A, connection to a single-phase power socket conforming to standard IEC 60309

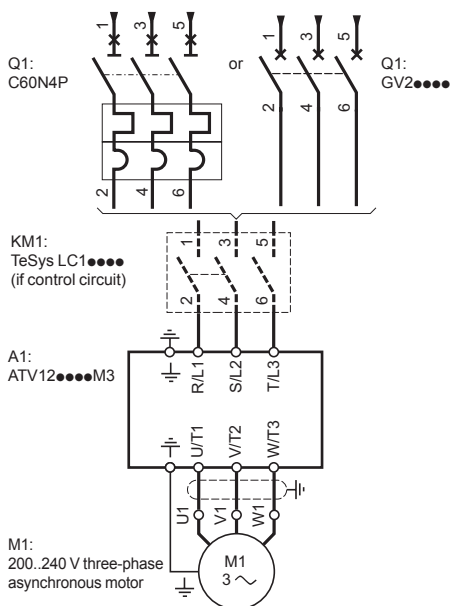

Motor starter with three-phase power supply

Motor starters (continued)

Standard power ratings of three-phase 4-pole 50/60 Hz motors (2)	Variable speed drive	Combination with control circuit (circuit-breaker + contactor)			TeSys contactor (1)	
		Minimum configuration (circuit-breaker only)				
kW	HP		TeSys motor circuit-breaker (3)	Operating range or rating	Maximum short-circuit current Icu	
			Modular circuit-breaker (4)	A	kA	
M1	A1	Q1				KM1
Three-phase supply voltage: 200...240 V 50/60 Hz						
0.18	0.25	ATV12H018M3	GV2ME07	1.6...2.5	> 100	LC1K09
			GV2L07	2.5	> 100	
			4-pole C60N	6	10	
0.37	0.55	ATV12●037M3	GV2ME08	2.5...4	> 100	LC1K09
			GV2L08	4	> 100	
			4-pole C60N	6	10	
0.75	1	ATV12●075M3	GV2ME14	6...10	> 100	LC1K09
			GV2L14	10	> 100	
			4-pole C60N	10	10	
1.5	2	ATV12●U15M3	GV2ME16	9...14	> 100	LC1K12
			GVL16	14	> 100	
			4-pole C60N	16	10	
2.2	3	ATV12●U22M3	GV2ME20	13...18	> 100	LC1D18
			GV2L20	18	> 100	
			4-pole C60N	20	10	
3	-	ATV12●U30M3	GV2ME21	17...23	50	LC1D25
			GV2L22	25	50	
			4-pole C60N	20	10	
4	5	ATV12●U40M3	GV2ME32	24...32	50	LC1D25
			GV2L22	25	50	
			4-pole C60N	32	10	

Combinations of C60N circuit-breakers/Vigi C60 add-on modules

C60N 2-pole/4-pole	Vigi C60		
Rating (A)	Rating (A)	Type (5)	Sensitivity
6	25	A "si"	30 mA
10	25	A "si"	30 mA
16	25	A "si"	30 mA
20	25	A "si"	30 mA
32	40	A "si"	30 mA

Recommendations for special uses:

- All RH10/RH21/RH99/RHU residual current protection devices with separate sensors are compatible as long as the type and sensitivity of the add-on modules given in the table above are observed.
- It is advisable to connect one RCD (residual current device) per drive. In this case, a type B RCD must not be located downstream of a type A or AC RCD.

(1) For a complete list of references for TeSys contactors, please refer to the "Motor starter solutions - Control and protection components" and "Motor starters up to 150 A" catalogues or visit "www.schneider-electric.com".

(2) Motor power indicated for combination with an ATV12H●●●●● drive with the same rating. For combination with an ATV12P●●●●● drive, refer to the specific manual for the Altivar 12 base plate version, available on our website at "www.schneider-electric.com".

(3) TeSys motor circuit-breakers:

- GV2ME●●: Thermal magnetic motor circuit-breakers with pushbutton control
- GV2L●●: Magnetic motor circuit-breakers with control by rotary knob

(4) 4-pole C60N modular circuit-breaker

(5) For additional protection against direct contact, with a three-phase power supply and access to the DC bus terminals (PA/+ and PC /-), the add-on module must be type B with a sensitivity of 30 mA.

A			
ATV12H018F1	16	VW3A8306R30	21
	17	VW3A8306RC	21
ATV12H018M2	16	VW3A8306TF03	21
	17	VW3A8306TF10	21
ATV12H018M3	16	VW3A9317	18
	17	VW3A9523	18
ATV12H037F1	16	VW3A9524	18
ATV12H037M2	16	VW3A9525	18
ATV12H037M3	16	VW3A9804	18
ATV12H055M2	16	VW3A9805	18
ATV12H075F1	16	VW3A31451	21
ATV12H075M2	16	VW3A31452	21
ATV12H075M3	16	VW3A31453	21
ATV12HU15M2	16	VZ3V1301	21
ATV12HU15M3	16	VZ3V1302	21
ATV12HU22M2	16		
ATV12HU22M3	16		
ATV12HU30M3	16		
ATV12HU40M3	16		
ATV12P037F1	17		
ATV12P037M2	17		
ATV12P037M3	17		
ATV12P055M2	17		
ATV12P075M2	17		
ATV12P075M3	17		
ATV12PU15M3	17		
ATV12PU22M3	17		
ATV12PU30M3	17		
ATV12PU40M3	17		
L			
LU9GC3	21		
T			
TCSMCNAM3M002P	19		
TCSWAAC13FB	19		
V			
VW3A1006	20		
VW3A1007	20		
VW3A1104R10	20		
VW3A1104R30	20		
VW3A4416	20		
VW3A4417	20		
VW3A4418	20		
VW3A4419	20		
VW3A4551	21		
VW3A4552	21		
VW3A4553	21		
VW3A4554	21		
VW3A8115	19		
VW3A8120	19		
VW3A8121	19		
VW3A8126	19		
VW3A8306R	21		
VW3A8306R03	21		
VW3A8306R10	21		

Altivar drives



<https://sid1.hu/>

Schneider Electric Industries SAS

Head Office
35, rue Joseph Monier
F-92500 Rueil-Malmaison
France

www.schneider-electric.com/drives

The information provided in this documentation contains general descriptions and/or technical characteristics of the performance of the products contained herein. This documentation is not intended as a substitute for and is not to be used for determining suitability or reliability of these products for specific user applications. It is the duty of any such user or integrator to perform the appropriate and complete risk analysis, evaluation and testing of the products with respect to the relevant specific application or use thereof. Neither Schneider Electric nor any of its affiliates or subsidiaries shall be responsible or liable for misuse of the information contained herein.

Design: Schneider Electric
Photos: Schneider Electric

DIA2ED2130101EN